

SUMA FURNITUREN

SCHMUCK-FURNITUREN IN GOLD, SILBER, PLATIN
JEWELLERY FINDINGS IN GOLD, SILVER, PLATINUM

KATALOG 2025

Ausgabe Februar 2025



Meine Kundennummer:

SUMA Werner Malok GmbH
Mulde 10 (Industriegebiet)
D- 75239 Eisingen
Deutschland

Tel: +49 (0) 7232 / 809 454
www.sumafurnituren.de

Fax: +49 (0) 7232 / 809 453
info@sumafurnituren.de

SUMA FURNITUREN

Mulde 10 D-75239 Eisingen • ☎ +49 (0) 7232 809 454 • 📠 +49 (0) 7232 809 453 • ✉ info@sumafurnituren.de • www.sumafurnituren.de

Sehr geehrte Kundin, sehr geehrter Kunde,
wir möchten Ihnen gerne unser aktualisiertes Lieferprogramm für Schmuckfurnituren vorstellen und freuen uns, Ihnen unseren neuen Katalog inkl. Preisangaben überreichen zu dürfen.

Für Sie das Wichtigste in Kürze zusammengefasst:

- Alle Preisangaben im Katalog sind in Euro (EUR) und unverbindlich. Es kommen die am Tage der Lieferung gültigen Preise in Anrechnung. Gerne unterbreiten wir Ihnen auch ein tagesaktuelles Angebot. Fragen Sie uns!
- Wenn nichts anderes vereinbart ist, gelten die Preise ab Werk Eisingen, zuzüglich Porto, Verpackung, Versicherung und gesetzliche Mehrwertsteuer (derzeit 19%).
- Für Kunden aus der Europäischen Union: Bitte geben Sie bei einer Bestellung immer Ihre gültige VAT-Nr. (UStId-Nr./Steuer-Id-Nummer) an. Die Warenlieferungen erfolgen dann mehrwertsteuerfrei. Ist keine VAT-Nr. vorhanden, so sind wir verpflichtet, Ihnen die gesetzliche Mehrwertsteuer in Rechnung zu stellen.
- Zahlung bei Erstlieferungen: Erstlieferungen erfolgen gegen Vorkasse oder Nachnahme.
- Datenverarbeitung: Wie speichern erforderliche personenbezogene Daten gem. § 28 BDSG.
- Druckfehler, Irrtümer und Änderungen vorbehalten.

Vielen Dank für Ihr Interesse an unseren Produkten.

Adresse:

SUMA Werner Malok GmbH
Mulde 10 (Industriegebiet)
75239 Eisingen
Deutschland

Telefon: +49 (0) 7232 / 80 94 54

Fax: +49 (0) 7232 / 80 94 53

E-Mail: info@suma-gmbh.de, info@sumafurnituren.de

Web: www.suma-gmbh.de, www.sumafurnituren.de

Geschäftsführer: Werner Malok, Isabell Malok
UStId-Nr. DE 144 200 826
Eingetragen im Handelsregister Mannheim HRB 502676

Dear customer,

we would like to present you with our latest delivery programme for findings. We are very pleased to offer you our new catalogue including price quotations.

Our terms and conditions are:

- All prices in the catalogue are in Euro (EUR) and per piece (not pair).
- Furthermore all prices are without obligation, until the delivery/shipment day from Eisingen and are quoted ex works.
- the customers of the European Union should give us their valid VAT-No. If you don't have one, we have to charge the German VAT with the current VAT rate of 19%.
- Payment: Payment in advance or cash on delivery (if possible). Charges are paid by customers.
- Data processing: we save required personal data according to § 28 BDSG.
- Subject to change without prior notice. No liability accepted for printing errors.

Thank you for considering us.

Head office:

SUMA Werner Malok GmbH
Mulde 10
D- 75239 Eisingen
Germany

Telefon: +49 (0) 7232 / 80 94 54

Fax: +49 (0) 7232 / 80 94 53

E-Mail: info@suma-gmbh.de, info@sumafurnituren.de

Web: www.suma-gmbh.de, www.sumafurnituren.de

Directors: Werner Malok, Isabell Malok
VAT-Nr. DE 144 200 826
Entered in the Register of Companies / Handelsregister Mannheim HRB 502676

Informationen zu unserem SUMA-Furnituren-Katalog 2025



Die Lupe

Sie zeigt eine vergrößerte Detailansicht der Produkte.



Das Informations-i

Hier finden Sie hilfreiche Informationen und Tipps rund um das betreffende Produkt.



Das NEU-Zeichen

Diese Artikel sind NEU in unserem Sortiment.

Galvanik

Nahezu alle Produkte in unserem Katalog können in unterschiedlichen Farbtönen galvanisiert werden.

Es stehen zur Auswahl:

- Farb-Vergoldung / Farbgold-Plattierung:

- 585 GG-Farbe
- 750 GG-Farbe
- Rose-Farbe RN4
- Rot-Farbe RN5
- Feingold-Farbe

- Versilberung

- Rhodinierung

- Gelbgold-Plattierung:

- 3 Milliem:
- 5 Milliem:
- 10 Milliem:
- 20 Milliem:

Verwendete Abkürzungen im Katalog:

VG

VS

RH

GGP 03

GGP 05

GGP 10

GGP 20

Lieferzeit:

Regellieferzeit für Galvanik: 5-8 Tage

Bitte haben Sie Verständnis, dass nicht immer alle Artikel im galvanisierten Zustand ab Lager lieferbar sind!















Achtung: Durch die Galvanisierung können die Furnituren in Ihren Lauf- und Funktionseigenschaften beeinflusst werden.

Wir übernehmen keinerlei Haftung o.ä., wenn Schäden an der Furnitur auftreten.

Auf Kundenwunsch galvanisierte Artikel sind vom Umtausch ausgeschlossen!

NEU

Neue Produkte im SUMA Furnituren-Katalog 2025

Seite 46 Karabiner, flach	Seite 46 Karabiner	Seite 49 Karabiner
		
Artikel-Nr. 233/11	Artikel-Nr. 232/16	Artikel-Nr. 357/8
Seite 79 Logoplättchen, oval	Seite 80 Logoplättchen, rund	Seite 80 Logoplättchen, rund
		
Artikel-Nr. 276/8/0,5	Artikel-Nr. 275/8/0,5	Artikel-Nr. 2752/8/0,5
Seite 98 Perldraht 0,8 mm	Seite 99 Perldraht 2,25 mm	Seite 100 Kordeldraht 0,90 mm
{ Neue Größe }	{ Neue Größe }	{ Neue Größe }
		
Artikel-Nr. 286/0,8	Artikel-Nr. 286/2,25	Artikel-Nr. 490/0,9
Seite 106 Olivdraht	Seite 106 Olivdraht	Seite 210 Panzerkette, weit, länglich
		
Artikel-Nr. 497/1,5	Artikel-Nr. 497/1,75	Artikel-Nr. 43100
Seite 222 Ankerkette, weit	Seite 238 Gliederkette, weit	Seite 238 Gliederkette, weit
		
Serien-Artikel-Nr. 52050	Artikel-Nr. 44065	Artikel-Nr. 44070

...und noch viele mehr!

Inhaltsverzeichnis

A

Abstandsringe.....	164
Abzeichenknöpfe.....	107
Achterform Karabiner.....	47, 48
Achterform Karabiner mit Kappen.....	48
Anhängerplättchen mit Öse.....	78, 80
Anhängerplättchen mit Öse und Schlaufe.....	78, 79, 80, 81
Anhängerschlaufen.....	71, 72
Anhängerschlaufen zum Einhängen.....	71, 72
Ankerkette 183, 184, 185, 188, 189, 190, 191, 218, 219, 224, 225, 234	
Anlötschlaufen.....	72, 73
Armbänder.....	172, 173, 175, 182, 186, 187, 197, 198
Extra weite Ankerkette.....	186, 187
Figaro-Panzer.....	175
Kugelmkette.....	197, 198
Kugelmkette, mehrreihig.....	200
Panzer.....	172, 173
Auflöt-Ornamente.....	246, 247, 248, 249, 250, 251, 252, 253
Anker.....	249
Blätter.....	246, 248
Blumen.....	248
christliche Motive.....	249
Dekor.....	250, 251
Eicheln.....	247
Eichenlaub.....	247
Herz.....	249
Hufeisen.....	249
Kleeblatt.....	249
Kränze.....	250
Krone.....	251
Lyra.....	249
Muschel.....	249
Ornamente.....	251, 252, 253
Ornament mit Blumen und Blätter.....	248
Pilz.....	248
Schleife.....	249
Schmetterling.....	249
Stern.....	249
Tiere.....	249
Wappen.....	250
Weinblätter.....	247
Weinrebe.....	247

B

Bajonettverschlüsse.....	58, 59
Biegeringe, oval.....	67
Biegeringe, rund.....	66, 67, 68, 69
Biegeringsortimente.....	69
Blech.....	94
Borten.....	96, 97
Brisuren.....	1, 2, 3
Broschierungen.....	109
Broschnadeln.....	109
Broschscharniere.....	108
Broschteile.....	108, 109
Buchstaben.....	141, 142

C

Charnierrohr, quadratisch.....	93
Charnierrohr, rund.....	93
Chatons.....	120, 121, 122, 123, 124, 125, 126, 127, 128
Clip für Anhänger.....	71
Collierketten.....	169 - 208
Ankerkette.....	183, 184, 185, 188, 189, 190, 191
Erbskette.....	179
Extra weite Ankerkette.....	186, 187
Figaro-Panzer.....	175
Fuchsschwanzkette.....	194, 195, 196
Kugelmkette.....	197, 198

Kugelmkette, mehrreihig.....	200, 201, 202, 203
Omega-Reifen.....	204, 205
Panzer.....	169, 170, 171, 174
Rundketten.....	176
Schlangenkette.....	176
Schlangenkette vierkant.....	178
Venezianerkette.....	192, 193
Venezianer-Schlauchketten.....	206, 207, 208
Weitankerkette.....	186
Collierschließen.....	50, 61, 62, 63
Collierschließen mit Kappen.....	50
Creolen.....	29, 30, 31

D

Doppelösen.....	70
Draht.....	94
Drahtbrisuren.....	32

E

Edelstahl-Bajonettverschlüsse.....	58, 59
Edelstahlseile.....	240, 241, 242, 243
Eierstabdraht.....	104, 105
Einhänger.....	63
Einlagen für Ohrclips.....	10
Einschnappringe.....	61, 62
Einschnappringe mit Öse.....	62, 63
Endkappen, gegossen.....	84
Endkappen, gepresst.....	91, 92
Endkappen, konisch.....	92
Endkappen, rund.....	91, 92
Endkapseln, zylindrisch.....	89, 90
Endröhrchen.....	91
Endschalen.....	166
glatt.....	166
Erbskette.....	179, 180, 181, 182, 215, 216, 217, 234, 237

F

Fassungen.....	120 - 138
Federringe.....	51, 52, 53, 54, 55, 56, 57
Figaro-Panzerkette.....	175, 212
Formdraht.....	94, 98, 99, 100, 101, 102, 103, 104, 105, 106
Fuchsschwanzkette.....	194, 195, 196, 226

G

Galerie-Bänder.....	96, 97
Gegossene Endkappen.....	84, 85
Gepresste Endkappen mit Öse.....	92
Gliederkette.....	238, 239
Große Schmuckfederringe.....	55
Große Schmuckfederringe mit Kappen.....	56, 57
Große Schmuckfederringe mit zwei Doppelösen.....	55
Guss-Chatons.....	123, 124, 125, 126, 127, 128
Gusskarabiner.....	42, 43, 44, 45, 47, 48, 50

H

Hakenverschlüsse.....	64
Hebel-Druck-Schließe.....	60
Hohlkugeln 143, 144, 145, 146, 147, 148, 149, 150, 151, 152, 153, 154, 155, 163	
Hohlkugeln.....	156, 157
Hohlringe.....	159, 160, 161, 162, 164

I

ID-Plättchen.....	70, 78, 79, 80, 81
-------------------	--------------------

J

K

Kalotten	86, 87, 88
Kapseln, rund	86, 87, 88
Kapseln, zylindrisch	89, 90
Karabiner	39, 40, 41, 42, 43, 44, 45, 46, 47, 48, 49, 50
Achterform	47, 48
Achterform mit Kappen	48
Barockform, bauchig	39, 42, 43, 44, 45, 47
flach	39, 40, 41
Karabiner mit Doppelzierbund	42, 43, 44, 45, 47
Karabiner mit eingehängter Öse	40, 41
Karabiner mit Kappen	50
rund	49
Kautschukband	245
Ketten, Meterware	209, 210, 211, 212, 213, 214, 215, 216, 217, 218, 219, 220, 221, 222, 223, 224, 225, 226, 227, 228, 229, 230, 231, 232, 233, 234, 235, 236, 237, 238, 239
Ankerkette	218, 219, 220, 221, 222, 223, 224, 225
Erbskette	215, 216, 217
Figaro-Panzerkette	212
Foxschlauchkette	227
Fuchsschwanzkette	226, 227
Gliederkette	238
Große Ankerkette	234, 235, 236
Große Erbskette	234, 236, 237
Große Flachankerkette	234, 235, 236
Kombikugelnkette	230
Kugelnkette	228, 229
Kugelnkette, mehrreihig	232, 233
Olivkette	230
ovale Erbskette	216
Ovale Erbskette	215
Panzerkette	209, 210, 211
Rundkette	213
Schlangenkette	213
Venezianerkette	214, 215
Weitankerkette	220, 221, 222, 223
Klappkapseln	92
Klemmschrauben	3
Klemmsicherung	107
Knopfsicherungen	107
Konische Endkappen	92
Kopfstifte	74
Kordeldraht	100, 101, 102, 103
Krawattenklammern	113
Krawattenklemmsicherung	113
Krawattennadelsicherung	107
Krawattennadelstiele	107
Krawattenschieber	113
Kugeldraht	98, 99
Kugelhaken	108
Kugeln	143 - 163
1-Loch-Kugeln, glatt	154, 155
1-Loch-Kugeln	155
Disko-Kugeln	150, 151, 152
Drahtgeflecht	153, 163
gerieft	149
glatt	143, 144, 145, 146, 147
Hohlringe, glatt	159, 160, 162
Hohlringe, Sterneffekt	161
Linsenform, glatt	156, 157, 158
Kugellohrstecker	23
Kugelschlösser	64
Kugelsicherungen	108

L

Linsenohrstecker	23
Logoplättchen	78, 79, 80, 81
Lötbrisen	1, 3
Lötrohrclip	5

M

Magnetschlösser	64, 65
Manschettenknopfmechaniken	110, 111, 112
Münzfassungen	139, 140
Münzfassungen mit Kordelrand und Schlaufe	140
Münzfassungen mit Öse und Schlaufe	139, 140

N

Nadeln	107, 109
Nadelsicherung	107
Nadelstiele	107

O

Ohrbrisen	1, 2, 3
Ohrbrisen mit Kugel und Öse	1
Ohrbrisen mit Öse	1, 2, 3
Ohrbrisen mit Perlschale	2
Ohrbrisen mit Platte	1
Ohrbrisen zum Löten	1, 3
Ohrclipeinlagen	10
Ohrclip-Rückteile	4, 6, 7, 8, 9
Ohrclips	4, 5, 6, 7, 8, 9
Ohrclips mit Fassung	4
Ohrclips mit Öse	4
Ohrclips mit Perlschale	5
Ohrclips mit Platte	4
Ohrclips zum Löten	4, 5, 6, 7, 8, 9
Ohrhaken	32, 33, 34, 35, 36, 37, 38
Ohrhaken mit Fassung	36, 37, 38
ovale Fassung	36, 37, 38
runde Fassung	36, 37, 38
Ohrhaken mit Öse	33
Ohrhaken mit Perlkappen	34
Ohrhaken mit Perlkappenanhänger	34
Ohrhaken mit Perlschale	32
Ohrhaken mit Tulpe	35
Ohrhaken mit Tulpenanhänger	35
Ohrhaken-Stopper	11
Ohrmuttern	11, 12, 13, 16, 17, 18, 19, 20, 21
Ohrmuttern aus Plastik	11
Ohrmuttern mit Metalleinsatz	11
Ohrmuttern mit Platte, gelötet	18, 19, 20, 21
flache Platte	18, 19, 20, 21
Ohrschauben	3, 12
Ohrschauben-Muttern	12
Ohrschauben-Stifte mit Gewinde	12
Ohrstecker	12, 13, 22, 23, 24, 26, 27, 28
Ohrstecker mit Fassung	26, 27, 28
oval	28
rund	26, 27
Ohrstecker mit Kugel	23
Ohrstecker mit Linse	23
Ohrstecker mit Perlschale	24
Ohrstecker mit Platte	22
Ohrstecker mit Platte und Öse	22
Ohrstecker mit Platte und Stift	22, 23
Ohrstecker mit runder Fassung	26
Ohrstecker mit Zarge	22
Ohrsteckerstifte	14, 15
Ohrsteckerunterlegscheibe	11
Olivdraht	106
Olivkette	230
Omegaohrclips	6, 7, 8, 9
Omega-Reifen	204, 205
Ösen, oval	67, 69
Ösen, rund	66, 67, 68, 69
Ösensortimente	69

SUMA FURNITUREN

Mulde 10 D-75239 Eisingen • ☎ +49 (0) 7232 809 454 • 📠 +49 (0) 7232 809 453 • ✉ info@sumafurnituren.de • www.sumafurnituren.de

P

Panzerkette	169, 170, 171, 174, 209, 210, 211
Paperclip-Kette	238, 239
Perlbrisuren	1
Perldraht	98, 99
Perl-Ohrclips	5
Perlohrhaken	32, 33, 34, 35, 36
Perl-Ohrstecker	24, 25
Perl-Ohrstecker mit Öse	24
Perlschalen	166
Perlschalenanhänger	75, 76, 77
Plastikohrmuttern	11
Plattenohrstecker	22, 23

Q

Quetschhülsen	244
Quetschperlen	244
Quetschzange	244

R

Ringeinlagen	11, 114
Rohrabschnitte	165
Rohre	93
Ronden	167, 168
Rückteile für Ohrbrisuren	3
Rückteile für Ohrclips	4, 6, 7, 8, 9
Rundkette	176, 213

S

Schiebesicherungen	109
Schlangenkette	176, 178, 213
Schlangenkette rund	176
Schlangenkette vierkant	178
Schließen mit Hebel-Druck-System	60
Schlüsselkette	114
Schlüsselring	114, 117
Schlüsselringe	115, 116
Schlüsselspaltringe	115, 116
Schmuckfederringe	55, 56, 57
Schmuckfederringe mit Kappen	56, 57
Schubhaken	109
S-Haken	64
Sicherheitsketten	119
Spaltringe	70
Sprengringe	70, 115, 116
Stahlseile	240, 241, 242, 243
Stahlseile, goldplattiert	242, 243
Steinfassungen	134, 135, 136
Steinfassungen mit Anhängerschlaufe	137, 138
Steinfassungen mit Öse	137, 138
Stempelanker	70
Stempelpfättchen	78, 80
Sternkapsel	88
Stück pin	12, 107
Stifte für Knopfsicherung	107
Stifte für Ohrstecker	14
Stiftösen	75

T

Tulpen	82, 83
Ohrhaken mit Tulpe	35
Tulpen mit Öse	83

U

Uhrketten-Federring	54
Uhrkettenkarabiner	54

V

Venezianerkette	192, 193, 214, 215
Venezianer-Schlauchketten	206, 207, 208, 232, 233
Verlängerungsketten	118
Verschluss-Haken	64

W

Weitankerkette	186, 187, 220, 221, 222, 223
Würfel	164

X







Y







Z

Zargen	129, 130, 131, 132, 133
Zargen-Ohrstecker	22
Zwischenglieder	253
Zylindrische Kapseln	89, 90

SUMA FURNITUREN



Mulde 10 D-75239 Eisingen • ☎ +49 (0) 7232 809 454 • 📠 +49 (0) 7232 809 453 • ✉ info@sumafurnituren.de • www.sumafurnituren.de

Ohrbrisen mit Öse Leverbacks with ring							
Länge in mm ca.	15	15	15	15	15	15	15
	Lilie	Millegriffes	Tropfen, glatt	Tropfen, glatt, Quer- öse	gerieft	Raute	Herz
Artikel-Nr.	10A	10B	10E	10H	10N	10F	10G
935 Silber 1 St.	•	•	•	•	•	•	•
935 Silber 10 St.	•	•	•	•	•	•	•
935 Silber 100 St.	•	•	•	•	•	•	•
935 Silber 1000 St.	•		•	•			
935 Silber VG 1 St.	•		•	•			
935 Silber VG 10 St.	•		•	•			
935 Silber VG 100 St.	•		•	•			
333 GG 1 St.	•		•	•			
585 GG 1 St.	•	•	•	•	•		
585 RotG 1 St.			•				
585 WG rhod. 1 St.			•	•			
750 GG 1 St.	•		•	•			

Ohrbrisen mit Kugel und Öse, Lötbrisen Leverbacks with ball and ring, leverbacks for soldering						
Länge in mm ca.	15	13	15	16,2	16,2	16,2
	Kugel-Ø ca. 3 mm				flacher Punkt	Halbkugel
Artikel-Nr.	10K/3	10L	10M	10R	10S	10T
935 Silber 1 St.	•	•	•	•	•	•
935 Silber 10 St.	•	•	•	•	•	•
935 Silber 100 St.	•	•	•	•	•	•
935 Silber VG 1 St.	•		•			
935 Silber VG 10 St.	•		•			
935 Silber VG 100 St.			•			
333 GG 1 St.	•					
585 GG 1 St.	•	•	•			
750 GG 1 St.		•	•			
750 WG 1 St.			•			

SUMA FURNITUREN

Mulde 10 D-75239 Eisingen • ☎ +49 (0) 7232 809 454 • 📠 +49 (0) 7232 809 453 • ✉ info@sumafurnituren.de • www.sumafurnituren.de





Ohrbrisen Leverbacks			
Länge in mm ca. (mit Öse)	18,6	15,2	17,2
Gesamtbreite in mm ca.	10,7	10,4	10,5
Artikel-Nr.	12E	12F	12G
935 Silber 1 St.	•	•	•
935 Silber 10 St.	•	•	•
935 Silber 100 St.	•	•	•









70/6B



73A/10

Ohrbrisen mit Perl- schale Leverbacks for pearls					
Perlschalen-Ø in mm ca.	4 gerieft	5 gerieft	6 gerieft	7 gerieft	8 gerieft
Länge in mm ca. (ohne Perlschale)	12,5	12,5	12,5	12,5	12,5
Artikel-Nr.	70/4B	70/5B	70/6B	70/7B	70/8B
935 Silber 1 St.	•	•	•	•	•
935 Silber 10 St.	•	•	•	•	•
585 GG 1 St.	•	•	•	•	•
585 WG Pd 1 St.	•	•	•	•	•
750 GG 1 St.	•	•	•	•	•
750 WG Pd 1 St.					•

Ohrbrisen mit runder/ ovaler Fassung Leverbacks with round/ oval plain bezel							
Steingröße in mm ca.	5,5 rund	6,3 rund	8,2 rund	9,1 rund	10,0 rund	8,0 x 6,0 oval	10,1 x 8,2 oval
Artikel-Nr.	73A/5,5	73A/6,3	73A/8,2	73A/9,1	73A/10	74A/8	74A/10
935 Silber 1 St.	•	•	•	•	•	•	•
935 Silber 10 St.	•	•	•	•	•	•	•
585 GG 1 St.			•		•	•	



11C



65D



Die Clipteile der Ohrbrisuren werden aus 0,3 mm starkem Blech gefertigt.







Die Lötbrisuren 11 A + 11 C können auf Wunsch auch **unfiniert** geliefert werden; bitte bei der Bestellung vermerken.

Lötbrisuren, Rückteile für Ohrbrisuren, Leverbacks for soldering, findings for leverbacks						
	ohne Öse	ohne Öse	mit offener Öse	mit offener Öse	mit geschlossener Öse	mit geschlossener Öse
Länge in mm ca.	15,0	15,0	18,0	18,0	18,0	18,0
Artikel-Nr.	11A	11A/UNF	11B	11B/UNF	11C	11C/UNF
935 Silber 1 St.	•	•	•	•	•	•
935 Silber 10 St.	•	•	•	•	•	•
585 GG 1 St.	•	•	•	•	•	•
585 WG Pd 1 St.	•	•	•	•	•	•
750 GG 1 St.	•	•	•	•	•	•
750 WG Pd 1 St.	•	•	•	•	•	•

Lötbrisuren, Rückteile für Ohrbrisuren, Klemmschrauben Leverbacks for soldering, findings for leverbacks, Earring findings					
	mit Böckchen	ohne Böckchen			
Länge in mm ca.	12,0	12,0	27,0 x Ø 1,0		
Artikel-Nr.	65D	65F	171		
935 Silber 1 St.	•	•	•		
935 Silber 10 St.	•	•	•		
333 GG 1 St.	•	•			
585 GG 1 St.	•	•	•		
585 WG Pd 1 St.	•	•			
750 GG 1 St.	•	•	•		
750 RoseG 1 St.	•	•			
750 RotG 1 St.	•	•			
750 WG Pd 1 St.	•	•	•		

SUMA FURNITUREN

Mulde 10 D-75239 Eisingen • ☎ +49 (0) 7232 809 454 • 📠 +49 (0) 7232 809 453 • ✉ info@sumafurnituren.de • www.sumafurnituren.de

Ohrclips Ear clips						
Cliplänge in mm ca.	16,5	20,5	17,5	16,5	20,5	17,5
Materialstärke mm ca.	0,60	0,60	0,60	0,60	0,60	0,60
Artikel-Nr.	24A	24	26A	24AZ	24Z	26AZ
935 Silber 1 St.	•	•	•	•	•	•
935 Silber 10 St.	•	•	•	•	•	•
935 Silber 100 St.	•	•	•	•	•	•



24/10



25/10









26/10











33 A/25











Seitenansicht

Ohrclips mit Platte, Ohrclips mit Platte und Öse Ear clips with plate, Ear clips with plate and ring							
Platten-Ø in mm ca.	8,0	10,0	12,0	10,0	12,0	8,0	10,0
Cliplänge in mm ca.	16,5	16,5	16,5	20,5	20,5	16,5	16,5
	kurze Zunge			lange Zunge		kurze Zunge, mit Öse	
Artikel-Nr.	24/8	24/10	24/12	25/10	25/12	26/8	26/10
935 Silber 1 St.	•	•	•	•	•	•	•
935 Silber 10 St.	•	•	•	•	•	•	•

Ohrclips mit Fassung Ear clips with setting				
Innen-Ø in mm ca.	15,0	17,8 x 13,0	25,6 x 18,5	18,5 x 10,0
Außen-Ø x Höhe mm ca.	15,4 x 3,4	1,6	1,7	2,7
Cliplänge in mm ca.	16,5	16,5	16,5	16,5
Artikel-Nr.	33A/15	33B/17	33B/25	33B/18
935 Silber 1 St.	•	•	•	•
935 Silber 10 St.	•	•	•	•

Perl-Ohrclips mit Omegaohrclip-Bügel Ear clips for pearls with omega clip spring					
Perlschalen-Ø in mm ca.	4	5	6	7	8
Ohrcliplänge in mm ca.	15	15	15	16	17
Ohrbügellänge in mm ca.	14,5	14,5	14,5	14,5	14,5
Artikel-Nr.	16/4	16/5	16/6	16/7	16/8
935 Silber 1 St.	•	•	•	•	•
935 Silber 10 St.	•	•	•	•	•
333 GG 1 St.		•			
585 GG 1 St.	•	•	•		•
585 WG Pd 1 St.		•	•		•
750 GG 1 St.		•	•		•
750 WG Pd 1 St.		•	•		•

Lötohrclip, Ohrclips mit mehreren Perlschalen mit Omegaohrclip-Bügel Ear clip for soldering, ear clips for more pearls with omega clip spring					
Perlschalen-Ø in mm ca.		4 / 6	5 / 7	6	
Ohrcliplänge in mm ca.	15	15	16	18	
Ohrbügellänge in mm ca.	14,5	14,5	14,5	14,5	
Artikel-Nr.	16	17/4	17/5	18/6	
935 Silber 1 St.	•	•	•	•	
935 Silber 10 St.	•	•	•	•	
333 GG 1 St.	•				
585 GG 1 St.	•	•	•	•	
585 WG Pd 1 St.	•	•	•	•	
750 GG 1 St.	•	•	•	•	
750 WG Pd 1 St.	•	•	•	•	





Ohrclips mit Öse, Ohrclips mit Perlschale Ear clips with ring, Ear clips for pearls					
Cliplänge in mm ca.	16,9	15,3	15,3	16,0	
Kugel- / Perlschalen-Ø in mm ca.	Kugel: 5	Platte: 4	Perlschale: 4		
Artikel-Nr.	65A/5	65B	65H/4	65L	
935 Silber 1 St.	•	•	•	•	
935 Silber 10 St.	•	•	•	•	
935 Silber 100 St.				•	

i **Komplette Ohrclipsysteme mit Bügel in Omega-Form, Bökkchen und Finierdraht**

Unsere **bewährten Ohrclipsysteme** bieten wir Ihnen komplett mit **stabilen Bökkchen, Ohrclip-Bügel in Omega-Form** und **passendem Finierdraht** an.

Die solide Ausführung der Ohrclip-Bügel in der **Materialstärke von 1,20 mm** bildet die Basis für vielfältige Einsätze und Kreationen Ihres Ohrschmucks. Dazu passend gibt es verschiedene Modelle an Ohrclip-Bökkchen, die Sie alle mit diesen Ohrclip-Bügel kombinieren können.

Die Übersicht der Einzelkomponenten finden Sie auf Seite 8.

Omegaohrclips Omega ear clips					
Breite x Höhe in mm ca.	gerades Gussbökkchen, ca. 6,3 x 8,0 mm				
Ohrbügellänge mm	13	14,5	17	19	18
Artikel-Nr.	29B/13	29B/15	29B/17	29B/19	29E/18
935 Silber 1 St.	•	•	•	•	•
935 Silber 10 St.	•	•	•	•	•
333 GG 1 St.		•			
585 GG 1 St.	•	•	•	•	•
585 RotG 1 St.	•	•	•		
585 WG Pd 1 St.	•	•	•	•	•
750 GG 1 St.	•	•	•	•	•
750 RoseG 1 St.	•	•	•	•	•
750 RotG 1 St.	•	•	•	•	•
750 WG Pd 1 St.	•	•	•	•	•
950 Platin 1 St.	•	•			•

i **Empfohlene Ohrclip-Einlagen:**

Nr. 30B/13 + Nr. 2860
Nr. 30B/15





Nr. 30 B/17 + Nr. 2860/11
& Nr. 30 B/19







Nr. 30 E/18 + Nr. 2860/12



Die Übersicht der verschiedenen Ohrclip-Einlagen finden Sie auf Seite 10.





Komplette Ohrclipsysteme mit Bügel in Omega-Form, Bökkchen und Finierdraht



Omegaohrclips Omega ear clips					
Breite x Höhe in mm ca.	gebogenes Gussböckchen, ca. 7,2 x 7,1 mm				
Ohrbügellänge mm	13	14,5	17	19	18
Artikel-Nr.	50B/13	50B/15	50B/17	50B/19	50E/18
935 Silber 1 St.	•	•	•	•	•
935 Silber 10 St.	•	•	•	•	•
333 GG 1 St.		•			
585 GG 1 St.	•	•	•	•	•
585 RotG 1 St.	•	•	•		
585 WG Pd 1 St.	•	•	•	•	•
750 GG 1 St.	•	•	•	•	•
750 RoseG 1 St.	•	•	•	•	•
750 RotG 1 St.	•	•	•	•	•
750 WG Pd 1 St.	•	•	•	•	•
950 Platin 1 St.	•	•			•





Omegaohrclips Omega ear clips						
Breite x Höhe in mm ca.	gebogenes Gussböckchen ca. 7,0 x 8,1 mm			gebogenes Gussböckchen ca. 7,1 x 10,2 mm		
Ohrbügellänge mm ca.	14,5	17	19	14,5	17	19
Artikel-Nr.	51B/15	51B/17	51B/19	52B/15	52B/17	52B/19
935 Silber 1 St.	•	•	•	•	•	•
935 Silber 10 St.	•	•	•	•	•	•
585 GG 1 St.	•	•	•	•	•	•
585 RotG 1 St.	•	•	•	•	•	
585 WG Pd 1 St.	•	•	•	•	•	•
750 GG 1 St.	•	•	•	•	•	•
750 RoseG 1 St.	•	•	•	•	•	•
750 RotG 1 St.	•	•	•	•	•	•
750 WG Pd 1 St.	•	•	•	•	•	•
950 Platin 1 St.	•			•		

SUMA FURNITUREN

Mulde 10 D-75239 Eisingen • ☎ +49 (0) 7232 809 454 • 📠 +49 (0) 7232 809 453 • ✉ info@sumafurnituren.de • www.sumafurnituren.de

Omegaohrclip-Bügel Omega ear clip spring					
Ø Bügel in mm ca.	8,6	8,6	9,7	9,7	11,0
Ohrbügellänge in mm ca.	13	14,5	17	19	18
Artikel-Nr.	30B/13	30B/15	30B/17	30B/19	30E/18
935 Silber 1 St.	•	•	•	•	•
935 Silber 10 St.	•	•	•	•	•
333 GG 1 St.		•			
585 GG 1 St.	•	•	•	•	•
585 RotG 1 St.	•	•	•		
585 WG Pd 1 St.	•	•	•	•	•
750 GG 1 St.	•	•	•	•	•
750 RoseG 1 St.	•	•	•	•	•
750 RotG 1 St.	•	•	•	•	•
750 WG Pd 1 St.	•	•	•	•	•
950 Platin 1 St.	•	•			•

Omegaohrclip-Bügel Omega ear clip spring					
Ø Bügel in mm ca.	12,5	8			
Ohrbügellänge in mm ca.	20	20			
Artikel-Nr.	30F/20	30G/20			
935 Silber 1 St.	•	•			
935 Silber 10 St.	•	•			
585 GG 1 St.		•			
585 WG Pd 1 St.		•			
750 GG 1 St.	•	•			
750 RoseG 1 St.	•	•			
750 RotG 1 St.	•	•			
750 WG Pd 1 St.	•	•			

Omegaohrclip- Böckchen und Finierdraht Omega ear clip joint and rivet wire					
Breite x Höhe in mm ca.	6,3 x 8,0 mit 90° Arretierung	7,2 x 7,1	7,0 x 8,1	7,1 x 10,2	ca. 9 mm lang
Artikel-Nr.	29BB	50BB	51BB	52BB	30D
935 Silber 1 St.	•	•	•	•	•
935 Silber 10 St.	•	•	•	•	•
333 GG 1 St.	•	•			•
585 GG 1 St.	•	•	•	•	•
585 RotG 1 St.	•	•	•	•	•
585 WG Pd 1 St.	•	•	•	•	•
750 GG 1 St.	•	•	•	•	•
750 RoseG 1 St.	•	•	•	•	•
750 RotG 1 St.	•	•	•	•	•
750 WG Pd 1 St.	•	•	•	•	•
950 Platin 1 St.	•	•	•		•

SUMA FURNITUREN





Mulde 10 D-75239 Eisingen • ☎ +49 (0) 7232 809 454 • 📠 +49 (0) 7232 809 453 • ✉ info@sumafurnituren.de • www.sumafurnituren.de









Ohrclip-Einlagen vermindern den direkten Druck des Clips auf das Ohrläppchen und sorgen für ein angenehmeres Tragegefühl am Ohr

Einlagen für Ohrclips aus hypoallergenem Silikon Inlay for ear clips from hypo-allergenic silicone rubber						
	flache Ausführung			gewölbte Ausführung		
Ø x Höhe in mm ca.	9,0 x 3,5	11,0 x 3,5	12,0 x 4,0	9,0 x 4,5	10,5 x 3,5	12,0 x 3,9
Artikel-Nr.	2860	2860/11	2860/12	2861	2861/11	2861/12
1 St.	•	•	•	•	•	•
10 St.	•	•	•	•	•	•
100 St.	•	•	•	•	•	•

Einlagen für Ohrclips Inlay for ear clips					
	Länge x Breite x Höhe / Ø in mm ca.	16,5 x 9,5 x 5,0	17,5 x 12,0 x 4,5	6,5	9
Ø Stöpsel in mm ca.			3	4	5
		weiß	transparent	transparent	transparent
passend für Ohrclip			26 A	24 A	24
Artikel-Nr.	2273	2272	111/3	111/4	111/5
1 St.	•	•	•	•	•
10 St.	•	•	•	•	•
100 St.	•	•	•	•	•

Ohrhaken-Stopper, Ringeinlagen aus Silikon Stopper for ear hooks, inlay for rings				
Länge x Ø in mm ca.	3,5 x 4,0	5,0 x 5,5	13,0 x 3,4	12,5 x 6,2
	Ohrhaken-Stopper		Ringeinlagen	
Artikel-Nr.	2275	2276	2870	2871
1 St.	•	•	•	•
10 St.	•	•	•	•
100 St.	•	•	•	•
1000 St.	•	•		

Ohrsteckerunterleg- scheibe, Plastik- ohrmuttern Disc for ear pins, plastic ear nuts							
Ø in mm ca. bzw. Länge x Ø in mm ca.	11,0	11,0	5,8 x 6,0	11,0	4,6	11,0	4,6
				mit goldfarbenem Metalleinsatz		mit silberfarbenem Metalleinsatz	
				nur für Ohrsteckerstifte mit max. Ø 0,90 mm geeignet			
Artikel-Nr.	2852	2850W	2277	2851G	2853G	2851W	2853W
1 St.	•	•	•	•	•	•	•
10 St.	•	•	•	•	•	•	•
100 St.	•	•	•	•	•	•	•
1000 St.		•	•				



Anwendungsbeispiel Artikel-Nr. 2275
Lieferung ohne Ohrhaken



Anwendungsbeispiel Artikel-Nr. 2870 +
2871 Lieferung ohne Ring



geeignet z.B. bei verdickten Finger-
gelenken zur Stabilisierung des Ringes;
kann bei Bedarf auch gekürzt werden

Anwendungsbeispiel Artikel-Nr. 2273
Lieferung ohne Ohrclip



Anwendungsbeispiel Artikel-Nr. 2850W
Lieferung ohne Ohrsteckerstift





SUMA FURNITUREN

Mulde 10 D-75239 Eisingen • ☎ +49 (0) 7232 809 454 • 📠 +49 (0) 7232 809 453 • ✉ info@sumafurnituren.de • www.sumafurnituren.de

Ohrstecker-Sets

bestehend aus einem Ohrsteckerstift und einer Ohnmutter.



Ohrstecker Stick-Pin Ear studs			
Maße Mutter in mm ca.	Ø 7,0 2,3 mm hoch gewölbt glatte Drücker	Ø 6,0 1,5 mm hoch leicht gewölbt geriefte Drücker	Ø 7,0 2,1 mm hoch leicht gewölbt geriefte Drücker
Maße Stift in mm ca.	11 mm lang Ø 1,05 mm 2 Rillen	10,0 mm lang Ø 0,80 mm 1 Rille	10,7 mm lang Ø 1,05 mm 1 Rille
Artikel-Nr.	25F	24K	24L
935 Silber 1 St.	•		
935 Silber 10 St.	•		
585 GG 1 St.	•		
585 RotG 1 St.	•		
585 WG Pd 1 St.	•		
750 GG 1 St.	•	•	•
750 RotG 1 St.	•	•	•
750 WG Pd 1 St.	•	•	•
950 Platin 1 St.	•	•	•



Ohrschrauben mit Gewinde / Ear screws



58 A



Bitte beachten Sie, dass unsere Ohrschrauben **kein metrisches Gewinde** haben, sondern ein eigens entwickeltes für die Schmuckfertigung mit besonderer Steigung.





Ohrschrauben, Stift mit Ganzgewinde, Ohr- schrauben-Muttern Ear screw nuts						
Ø / Länge in mm ca.	6 / 14	14	6			
Plattenform	Blume		Blume			
Artikel-Nr.	58UA	58U	58A			
935 Silber 1 St.	•	•	•			

Ohrstecker-Sets

bestehend aus einem Ohrsteckerstift und einer Ohnmutter.







25 C

Ohrstecker Ear studs					
bestehend aus	25S (10 mm) + 25B (Ø 5 mm)	Ohrmutter zu 25C	25T (11 mm) + 25M (Ø 7 mm)	25S (10 mm) + 25A (Ø 6 mm)	25T (11 mm) + 25A (Ø 6 mm)
Artikel-Nr.	25C	25B	25TM	25SA	25TA
935 Silber 1 St.	•	•	•	•	•
935 Silber 10 St.	•	•	•	•	•
935 Silber 100 St.	•	•	•	•	•
935 Silber 500 St.	•	•		•	•
935 Silber 1000 St.	•	•			
333 GG 1 St.	•	•	•	•	•
333 GG 10 St.	•	•	•	•	•
585 GG 1 St.	•	•	•	•	•
585 GG 10 St.	•	•	•	•	•
585 RoseG 1 St.	•	•		•	•
585 RoseG 10 St.	•	•		•	•
585 RotG 1 St.	•	•		•	
585 RotG 10 St.	•	•		•	
585 WG Pd 1 St.	•	•	•	•	•
585 WG Pd 10 St.	•	•	•	•	•
750 GG 1 St.	•	•	•	•	•
750 GG 10 St.	•	•	•	•	•
750 RoseG 1 St.	•	•		•	•
750 RoseG 10 St.	•	•		•	•
750 RotG 1 St.	•	•		•	•
750 RotG 10 St.	•	•		•	•
750 WG Pd 1 St.	•	•	•	•	•
750 WG Pd 10 St.	•	•	•	•	•
950 Platin 1 St.	•	•		•	



Ohrsteckerstifte mit 2 Rillen

Drahtstärke Ø 1,0 mm

Ohrsteckerstifte, mit 2 Rillen Stift-Ø 1,0 mm Ear pins, with 2 grooves pin Ø 1,0 mm					
Länge x Ø in mm ca.	10,0 x 1,0	11,0 x 1,0	12,0 x 1,0	14,0 x 1,0	
Artikel-Nr.	25S	25T	25W	25U	
935 Silber 1 St.	•	•	•	•	
935 Silber 10 St.	•	•	•	•	
935 Silber 100 St.	•	•	•	•	
935 Silber 500 St.	•	•	•	•	
935 Silber 1000 St.	•	•	•	•	
333 GG 1 St.	•	•		•	
333 GG 10 St.	•	•		•	
585 GG 1 St.	•	•	•	•	
585 GG 10 St.	•	•	•	•	
585 RoseG 1 St.	•	•	•	•	
585 RoseG 10 St.	•	•	•	•	
585 RotG 1 St.	•	•	•	•	
585 RotG 10 St.	•	•	•	•	
585 WG Pd 1 St.	•	•	•	•	
585 WG Pd 10 St.	•	•	•	•	
750 GG 1 St.	•	•	•	•	
750 GG 10 St.	•	•	•	•	
750 RoseG 1 St.	•	•	•	•	
750 RoseG 10 St.	•	•	•	•	
750 RotG 1 St.	•	•	•	•	
750 RotG 10 St.	•	•	•	•	
750 WG Pd 1 St.	•	•	•	•	
750 WG Pd 10 St.	•	•	•	•	
950 Platin 1 St.	•			•	

Ohrsteckerstifte mit 2 Rillen

Drahtstärke Ø 0,9 mm

Ohrsteckerstifte, mit 2 Rillen Stift-Ø 0,9 mm Ear pins, with 2 grooves pin Ø 0,9 mm					
Länge x Ø in mm ca.	10,0 x 0,9	14,0 x 0,9			
Artikel-Nr.	26S	26U			
935 Silber 1 St.	•	•			
935 Silber 10 St.	•	•			
935 Silber 100 St.	•	•			
585 GG 1 St.	•	•			
585 GG 10 St.	•	•			
585 RoseG 1 St.	•	•			
585 RoseG 10 St.	•	•			
585 RotG 1 St.	•	•			
585 RotG 10 St.	•	•			
585 WG Pd 1 St.	•	•			
585 WG Pd 10 St.	•	•			
750 GG 1 St.	•	•			
750 GG 10 St.	•	•			
750 RoseG 1 St.	•	•			
750 RoseG 10 St.	•	•			
750 RotG 1 St.	•	•			
750 RotG 10 St.	•	•			
750 WG Pd 1 St.	•	•			
750 WG Pd 10 St.	•	•			



Ohrmuttern

Diese Ohrmuttern werden aus einem Stück gefertigt und sind in unterschiedlichen Größen und Materialstärken erhältlich.



25B

Standardmodell, passend zu allen Ohrsteckern aus unserem Lieferprogramm

Standard type, recommended for all ear studs of our product range



25I



25H

kleine, starke Ohrmutter mit guter Formstabilität durch den doppelt gepresstem Innenrand

small, strong ear nut with high stability by double-pressed edge



25J

Ohrmuttern Ear nuts					
Ø in mm ca.	5,0	4,8	3,9	5,5	5,5
Gesamtbreite in mm ca.	5,9	6,1	6,6	7,1	7,1
Gesamthöhe in mm ca.	4,2	3,2	3,5	4,0	4,0
Materialstärke in mm ca.	Ag: 0,35 / Au: 0,30	0,30	0,45	0,40	0,50
	geriffelter Rand	glatter Rand	glatter Rand	geriffelter Rand	geriffelter Rand
	Standard ohrmutter				extra stark
Artikel-Nr.	25B	25I	25H	25JL	25J
935 Silber 1 St.	•	•	•		•
935 Silber 10 St.	•	•	•		•
935 Silber 100 St.	•	•	•		•
935 Silber 500 St.	•	•	•		•
935 Silber 1000 St.	•	•			
333 GG 1 St.	•	•	•		•
333 GG 10 St.	•	•	•		•
585 GG 1 St.	•	•	•	•	•
585 GG 10 St.	•	•	•	•	•
585 RoseG 1 St.	•				
585 RoseG 10 St.	•				
585 RotG 1 St.	•			•	
585 RotG 10 St.	•			•	
585 WG Pd 1 St.	•	•	•	•	•
585 WG Pd 10 St.	•	•	•	•	•
750 GG 1 St.	•	•	•	•	•
750 GG 10 St.	•	•	•	•	•
750 RoseG 1 St.	•		•	•	•
750 RoseG 10 St.	•		•	•	•
750 RotG 1 St.	•		•	•	
750 RotG 10 St.	•		•	•	
750 WG Pd 1 St.	•	•	•	•	•
750 WG Pd 10 St.	•	•	•	•	•
950 Platin 1 St.	•				



Ohrmuttern

Diese Ohrmuttern werden aus einem Stück gefertigt und sind in unterschiedlichen Größen und Materialstärken erhältlich.



26M



25M



25D

Ohrmuttern Ear nuts					
Ø in mm ca.	6	7,0	7,0	9,0	
Gesamtbreite in mm ca.	6,9	7,7	7,7	9,9	
Gesamthöhe in mm ca.	3,4	4,6	4,6	5,0	
Materialstärke in mm ca.	0,30	0,30	0,40	0,40	
	geriffelter Rand	geriffelter Rand	geriffelter Rand	geriffelter Rand extra groß	
Artikel-Nr.	26M	25ML	25M	25D	
935 Silber 1 St.	•		•	•	
935 Silber 10 St.	•		•	•	
935 Silber 100 St.	•		•	•	
935 Silber 500 St.	•				
333 GG 1 St.			•	•	
585 GG 1 St.	•	•	•	•	
585 GG 10 St.	•				
585 RotG 1 St.	•			•	
585 RotG 10 St.	•				
585 WG Pd 1 St.	•	•	•	•	
585 WG Pd 10 St.	•				
750 GG 1 St.	•	•	•	•	
750 GG 10 St.	•				
750 RotG 1 St.	•				
750 RotG 10 St.	•				
750 WG Pd 1 St.	•	•	•	•	
750 WG Pd 10 St.	•				



Ohrmuttern mit aufgelöteter Platte, *Standard-Ausführung* 0,40 mm Materialstärke

Unsere Ohrmuttern werden nach einem speziellen Produktionsverfahren gelötet, bei dem die Spannkraft der Feder erhalten bleibt. Die für diese Ohrmuttern verwendete Materialien sind alle 0,4 mm stark.



25A



25E



25K

Ohrmuttern mit aufgelöteter Platte, <i>Materialstärke 0,40 mm</i> Ear nuts with soldered plate, <i>thickness 0,40 mm</i>	NEU				
Platten-Ø in mm ca.	5,5	6	6	8	8
Artikel-Nr.	24S	25A	25R	25G	25E
935 Silber 1 St.	•	•	•	•	•
935 Silber 10 St.	•	•	•	•	•
935 Silber 100 St.	•	•	•	•	•
935 Silber 500 St.	•	•	•	•	•
333 GG 1 St.		•		•	•
333 GG 10 St.		•		•	•
585 GG 1 St.	•	•	•	•	•
585 GG 10 St.	•	•	•	•	•
585 RoseG 1 St.		•	•		•
585 RoseG 10 St.		•	•		•
585 RotG 1 St.		•		•	•
585 RotG 10 St.		•		•	•
585 WG Pd 1 St.		•	•	•	•
585 WG Pd 10 St.		•	•	•	•
750 GG 1 St.	•	•	•	•	•
750 GG 10 St.	•	•	•	•	•
750 RoseG 1 St.		•	•	•	•
750 RoseG 10 St.		•	•	•	•
750 RotG 1 St.		•	•	•	•
750 RotG 10 St.		•	•	•	•
750 WG Pd 1 St.		•	•	•	•
750 WG Pd 10 St.		•	•	•	•
950 Platin 1 St.		•	•		•



Ohrmuttern mit aufgelöteter Platte, *Standard-Ausführung* 0,40 mm Materialstärke

Unsere Ohrmuttern werden nach einem speziellen Produktionsverfahren gelötet, bei dem die Spannkraft der Feder erhalten bleibt. Die für diese Ohrmuttern verwendete Materialien sind alle 0,4 mm stark.







25A



25E



25K



Ohrmuttern mit aufgelöteter Platte, <i>Materialstärke 0,40 mm</i> Ear nuts with soldered plate, <i>thickness 0,40 mm</i>					
Platten-Ø in mm ca.	10	10	12	14	
Artikel-Nr.	25K	25L	25V	25N	
935 Silber 1 St.	•	•	•	•	
935 Silber 10 St.	•	•	•	•	
935 Silber 100 St.	•	•	•	•	
935 Silber 500 St.	•	•			
333 GG 1 St.	•	•			
333 GG 10 St.	•	•			
585 GG 1 St.	•	•	•	•	
585 GG 10 St.	•	•			
585 RoseG 1 St.	•				
585 RoseG 10 St.	•				
585 RotG 1 St.	•				
585 RotG 10 St.	•				
585 WG Pd 1 St.	•	•	•		
585 WG Pd 10 St.	•	•			
750 GG 1 St.	•	•	•	•	
750 GG 10 St.	•	•			
750 RoseG 1 St.	•	•	•	•	
750 RoseG 10 St.	•	•			
750 RotG 1 St.		•	•	•	
750 RotG 10 St.		•			
750 WG Pd 1 St.	•	•	•	•	
750 WG Pd 10 St.	•	•			
950 Platin 1 St.		•			



Ohrmuttern mit aufgelöteter Platte, Modell *leichte Ausführung* 0,30 mm Plattenstärke





Die Modell-Serie Nr. 42 werden mit Platten aus 0,30 mm starkem Material gefertigt; die Materialstärke der Feder hingegen bleibt bei 0,40 mm.

Ohrmuttern mit aufgelöteter Platte, Materialstärke 0,30 mm Ear nuts with soldered plate, thickness 0,30 mm				
Platten-Ø in mm ca.	8	8	10	
Artikel-Nr.	42G	42E	42L	
585 GG 1 St.	•	•	•	
585 GG 10 St.	•	•	•	
585 WG Pd 1 St.	•	•	•	
585 WG Pd 10 St.	•	•	•	
750 GG 1 St.	•	•	•	
750 GG 10 St.	•	•	•	
750 RotG 1 St.		•	•	
750 RotG 10 St.		•	•	
750 WG Pd 1 St.	•	•	•	
750 WG Pd 10 St.	•	•	•	







Ohrmuttern mit aufgelöteter Platte, offene Blümchen-Platte, Standard-Ausführung 0,40 mm Materialstärke

Ohrmuttern mit aufgelöteter Platte Ear nuts with soldered plate				
Platten-Ø in mm ca.	8	10		
Artikel-Nr.	250	25P		
935 Silber 1 St.	•	•		
935 Silber 10 St.	•	•		
585 GG 1 St.	•	•		
585 WG Pd 1 St.	•	•		
750 GG 1 St.	•	•		
750 WG Pd 1 St.	•	•		

Ohrmuttern mit gewölbter, aufgelöteter Platte - konvex gewölbt Standard-Ausführung 0,40 mm Materialstärke





36L

Ohrmuttern mit gewölbter, aufgelöteter Platte Ear nuts with domed, soldered plate					
Platten-Ø in mm ca.	6	8	10	12	
Artikel-Nr.	36R	36E	36L	36V	
935 Silber 1 St.	•	•	•	•	
935 Silber 10 St.	•	•	•	•	
585 GG 1 St.	•	•	•		
585 WG Pd 1 St.	•	•	•		
750 GG 1 St.	•	•	•	•	
750 RoseG 1 St.	•	•	•		
750 RotG 1 St.	•	•	•	•	
750 WG Pd 1 St.	•	•	•	•	
950 Platin 1 St.		•	•		







Ohrmuttern mit gewölbter, aufgelöteter Platte - konkav gewölbt Standard-Ausführung 0,40 mm Materialstärke



40L

Ohrmuttern mit gewölbter, aufgelöteter Platte Ear nuts with domed, soldered plate					
Platten-Ø in mm ca.	8	10			
Plattenform	rund	rund			
Artikel-Nr.	40E	40L			
935 Silber 1 St.	•	•			
935 Silber 10 St.	•	•			







Zargen-Ohrstecker / Ear studs for stones



Zargen-Ohrstecker mit Ohrmutter 25B Ear studs for stones with ear nut 25B							
Steingröße in mm ca.	2,0	2,5	3,0	3,5	4,0	5,0	6,0
Artikel-Nr.	66/2	66/2,5	66/3	66/3,5	66/4	66/5	66/6
925 Silber 1 St.	•	•	•	•	•	•	•
925 Silber 10 St.	•	•	•	•	•	•	•
585 GG 1 St.	•	•	•	•	•	•	•
585 WG Pd 1 St.	•	•	•	•	•		
750 GG 1 St.	•	•	•	•	•		



















Ohrstecker mit aufgelöteter Platte





Die Platte von unseren Ohrsteckern ist an den Ohrsteckerstift angelötet und nicht genietet.
Die Oberfläche der Platte ist gerade, glatt und plan.

Ohrstecker mit aufgelöteter Platte und Ohrmutter 25B Ear studs with plate and ear nut 25B							
Platten-Ø in mm ca.	2,0	3,0	4,0	5,0	6,0	8,0	10,0
Artikel-Nr.	22/2	22/3	22/4	22/5	22/6	22/8	22/10
935 Silber 1 St.	•	•	•	•	•	•	•
935 Silber 10 St.	•	•	•	•	•	•	•
935 Silber 100 St.	•	•	•	•	•	•	•
585 GG 1 St.		•	•	•	•		

Ohrstecker mit Platte und Stift / Platte, Öse und Ohrmutter 25B Ear studs with plate and pin / plate, ring and ear nut 25B						
Platten-Ø in mm ca.		8,0	10,0			
Artikel-Nr.	170	19/8	19/10			
935 Silber 1 St.	•	•	•			
935 Silber 10 St.	•	•	•			
935 Silber 100 St.	•	•	•			

Ohrstecker mit Kugel / und Öse sowie Ohr- mutter 25B Ear studs with ball / and ring and ear nut 25B								
Kugel-Ø in mm ca.	3,0	4,0	5,0	6,0	3,0	4,0	5,0	6,0
Artikel-Nr.	21/3	21/4	21/5	21/6	24/3	24/4	24/5	20/6
935 Silber 1 St.	•	•	•	•	•	•	•	•
935 Silber 10 St.	•	•	•	•	•	•	•	•
935 Silber 100 St.	•	•	•	•	•	•	•	•
585 GG 1 St.	•	•	•	•	•	•	•	•
585 WG Pd 1 St.	•				•	•		
750 GG 1 St.	•	•			•	•		

Ohrstecker mit Linse/ und Öse sowie Ohr- mutter 25B Ear studs with lens/ and ring and ear nut 25B								
Linsen-Ø in mm ca.	3,4	4,7	5,8	7,0	3,4	4,7	5,8	7,0
Artikel-Nr.	27A	27B	27C	27D	28A	28B	28C	28D
925 Silber 1 St.	•	•	•	•	•	•	•	•
925 Silber 10 St.	•	•	•	•	•	•	•	•
585 GG 1 St.	•	•			•	•		

Ohrstecker mit Platte, Stift und Ohrmutter 25B Ear studs with plate, pin and ear nut 25B					
Platten-Ø in mm ca.	4,0	5,0	6,0	8,0	10,0
Artikel-Nr.	34/4	34/5	34/6	34/8	34/10
935 Silber 1 St.	•	•	•	•	•
935 Silber 10 St.	•	•	•	•	•
935 Silber 100 St.	•	•	•	•	•

SUMA FURNITUREN

Mulde 10 D-75239 Eisingen ● ☎ +49 (0) 7232 809 454 ● 📠 +49 (0) 7232 809 453 ● ✉ info@sumafurnituren.de ● www.sumafurnituren.de



23/4

25/6





Perlohrstecker (Standardmodell Serie 23..., 13..., 25...)





Die Vorteile auf einen Blick:





- solide, stabile Ausführung und Verarbeitung des Ohrsteckers
- Perlschalen sind gelötet
- Durchmesser des Ohrsteckerstifts ist in Silber 1,0 mm, in Gold 0,9 mm; Gesamtlänge: 13 mm
- Die 2 Rillen am Steckerende sorgen für einen doppelten, sicheren Halt

Perl-Ohrstecker (geriefte Schale) mit Ohrmutter 25B Ear studs for pearls (corrugated cup) with ear nut 25B						
Perlschalen-Ø in mm	3,2 (glatt)	4,0	5,0	6,0	7,0	8,0
Artikel-Nr.	23/3	23/4	23/5	23/6	23/7	23/8
935 Silber 1 St.	•	•	•	•	•	•
935 Silber 10 St.	•	•	•	•	•	•
935 Silber 100 St.	•	•	•	•	•	•
935 Silber 1000 St.	•	•	•	•		
333 GG 1 St.		•	•	•		
333 GG 10 St.		•	•	•		
585 GG 1 St.	•	•	•	•	•	•
585 GG 10 St.	•	•	•	•	•	•
585 WG Pd 1 St.	•	•	•	•		
585 WG Pd 10 St.	•	•	•	•		
750 GG 1 St.	•	•	•	•		•
750 GG 10 St.	•	•	•	•		•
750 WG Pd 1 St.	•	•	•	•		
750 WG Pd 10 St.	•	•	•	•		

Perl-Ohrstecker/ mit Öse und Ohrmutter 25B Ear studs for pearls, ear studs for pearls with ring and ear nut 25B						
Perlschalen-Ø in mm ca.	3,2	4,0	5,0	6,0	4,0	5,0
Perlschale / cup ca.		glatt / smooth			gerieft / corrugated	
Artikel-Nr.	23/3	23/4G	23/5G	23/6G	13/4	13/5
935 Silber 1 St.	•	•	•	•	•	•
935 Silber 10 St.	•	•	•	•	•	•
935 Silber 100 St.	•	•	•	•	•	•
935 Silber 1000 St.	•	•	•	•		
585 GG 1 St.	•	•	•	•	•	•
585 GG 10 St.	•	•	•	•		
585 WG Pd 1 St.	•	•	•	•		
585 WG Pd 10 St.	•	•	•	•		
750 GG 1 St.	•	•	•	•		
750 GG 10 St.	•	•	•	•		
750 WG Pd 1 St.	•	•	•	•		
750 WG Pd 10 St.	•	•	•	•		

Perl-Ohrstecker (geriefte Schale) mit Ohrmutter 25A Ear studs for pearls (corrugated cup) with ear nut 25A					
Perlschalen-Ø in mm	4,0	5,0	6,0	7,0	8,0
Artikel-Nr.	25/4	25/5	25/6	25/7	25/8
935 Silber 1 St.	•	•	•	•	•
935 Silber 10 St.	•	•	•	•	•
935 Silber 100 St.	•	•	•	•	•
585 GG 1 St.	•	•	•	•	•
585 WG Pd 1 St.	•	•	•		
750 GG 1 St.	•	•	•		•
750 WG Pd 1 St.	•	•	•		

Perl-Ohrstecker (geriefte Schale) Ear studs for pearls (corrugated cup)						
Perlschalen-Ø in mm	4,0	5,0	6,0	7,0	8,0	
Artikel-Nr.	23S/4	23S/5	23S/6	23S/7	23S/8	
935 Silber 1 St.	•	•	•	•	•	
935 Silber 10 St.	•	•	•	•	•	
935 Silber 100 St.	•	•	•	•	•	
585 GG 1 St.	•	•	•	•	•	
585 WG Pd 1 St.	•	•	•			
750 GG 1 St.	•	•	•		•	
750 WG Pd 1 St.	•	•	•			

Perl-Ohrstecker (glatte Schale) Ear studs for pearls (corrugated cup)						
Perlschalen-Ø in mm ca.	3,2 (glatt)	4,0	5,0	6,0		
Artikel-Nr.	23S/3	23S/4G	23S/5G	23S/6G		
935 Silber 1 St.	•	•	•	•		
935 Silber 10 St.	•	•	•	•		
935 Silber 100 St.	•	•	•	•		
585 GG 1 St.	•	•	•	•		
585 WG Pd 1 St.	•	•	•	•		
750 GG 1 St.	•	•	•	•		
750 WG Pd 1 St.	•	•	•	•		

SUMA FURNITUREN

Mulde 10 D-75239 Eisingen • ☎ +49 (0) 7232 809 454 • 📠 +49 (0) 7232 809 453 • ✉ info@sumafurnituren.de • www.sumafurnituren.de



Ohrstecker mit runder Fassung und Ohrmutter 25B Ear studs for stones with ear nut 25B						
Steingröße in mm ca.	3,1	3,8	4,25	4,8	5,5	6,3
Außen-Ø x Höhe mm ca.	3,5 x 1,8	4,2 x 1,9	4,65 x 2,0	5,2 x 2,25	5,95 x 2,2	6,7 x 1,8
Artikel-Nr.	67A/3,1	67A/3,8	67A/4,25	67A/4,8	67A/5,5	67A/6,3
935 Silber 1 St.	•	•	•	•	•	•
935 Silber 10 St.	•	•	•	•	•	•
935 Silber 100 St.	•	•	•	•	•	•
585 GG 1 St.	•	•	•	•	•	•

Ohrstecker mit runden Fassungen und Ohrmutter 25B Ear studs for stones with ear nut 25B						
Steingröße in mm ca.	7,1	7,5	8,2	8,7	9,1	9,5
Außen-Ø x Höhe mm ca.	7,5 x 2,0	8,0 x 1,6	8,6 x 1,7	9,2 x 1,8	9,6 x 2,5	9,9 x 3,5
Artikel-Nr.	67A/7,1	67A/7,5	67A/8,2	67A/8,7	67A/9,1	67A/9,5
935 Silber 1 St.	•	•	•	•	•	•
935 Silber 10 St.	•	•	•	•	•	•
935 Silber 100 St.	•	•	•	•	•	•
585 GG 1 St.	•	•	•	•	•	•

Ohrstecker mit runden Fassungen und Ohrmutter 25B Ear studs for stones with ear nut 25B						
Steingröße in mm ca.	10,0	10,5	11,0	12,0	13,1	15,0
Außen-Ø x Höhe mm ca.	10,6 x 1,8	10,9 x 1,9	11,5 x 2,1	12,4 x 2,3	13,5 x 1,6	15,4 x 3,4
Artikel-Nr.	67A/10	67A/10,5	67A/11	67A/12	67A/13	67A/15
935 Silber 1 St.	•	•	•	•	•	•
935 Silber 10 St.	•	•	•	•	•	•
935 Silber 100 St.	•	•	•	•	•	•
585 GG 1 St.	•	•	•	•	•	•



67B/4,8
mit offener Öse



67C/4,8
mit geschlossener Öse



67B/10
mit offener Öse

Ohrstecker mit runder Fassung, Öse und Ohrmutter 25B Ear studs for stones with ring and ear nut 25B					
Steingröße in mm ca.	3,8	4,25	4,8	5,5	6,3
Außen-Ø x Höhe mm ca.	4,2 x 1,9	4,65 x 2,0	5,2 x 2,25	5,95 x 2,2	6,7 x 1,8
Artikel-Nr. <i>mit offener Öse</i>	67B/3,8	67B/4,25	67B/4,8	67B/5,5	67B/6,3
Artikel-Nr. <i>mit geschlossener Öse</i>	67C/3,8	67C/4,25	67C/4,8	67C/5,5	67C/6,3
935 Silber 1 St.	•	•	•	•	•
935 Silber 10 St.	•	•	•	•	•
935 Silber 100 St.	•	•	•	•	•

Ohrstecker mit runder Fassung, Öse und Ohrmutter 25B Ear studs for stones with ring and ear nut 25B						
Steingröße in mm ca.	7,1	7,5	8,2	8,7	9,1	9,5
Außen-Ø x Höhe mm ca.	7,5 x 2,0	8,0 x 1,6	8,6 x 1,7	9,2 x 1,8	9,6 x 2,5	9,9 x 3,5
Artikel-Nr. <i>mit offener Öse</i>	67B/7,1	67B/7,5	67B/8,2	67B/8,7	67B/9,1	67B/9,5
Artikel-Nr. <i>mit geschlossener Öse</i>	67C/7,1	67C/7,5	67C/8,2	67C/8,7	67C/9,1	67C/9,5
935 Silber 1 St.	•	•	•	•	•	•
935 Silber 10 St.	•	•	•	•	•	•
935 Silber 100 St.	•	•	•	•	•	•

Ohrstecker mit runder Fassung, Öse und Ohrmutter 25B Ear studs for stones with ring and ear nut 25B						
Steingröße in mm ca.	10,0	10,5	11,0	12,0	13,1	15,0
Außen-Ø x Höhe mm ca.	10,6 x 1,8	10,9 x 1,9	11,5 x 2,1	12,4 x 2,3	13,5 x 1,6	15,4 x 3,4
Artikel-Nr. <i>mit offener Öse</i>	67B/10	67B/10,5	67B/11	67B/12	67B/13	67B/15
Artikel-Nr. <i>mit geschlossener Öse</i>	67C/10	67C/10,5	67C/11	67C/12	67C/13	67C/15
935 Silber 1 St.	•	•	•	•	•	•
935 Silber 10 St.	•	•	•	•	•	•
935 Silber 100 St.	•	•	•	•	•	•

SUMA FURNITUREN

Mulde 10 D-75239 Eisingen • ☎ +49 (0) 7232 809 454 • 📠 +49 (0) 7232 809 453 • ✉ info@sumafurnituren.de • www.sumafurnituren.de

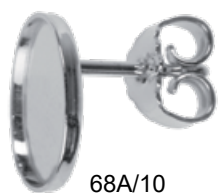

68A/10



68B/10
mit offener
Öse



68 /10
mit geschlossener
Öse







Die Vorteile auf einen Blick:





Solide, stabile Ausführung und Verarbeitung des Ohrsteckers mit 1,0 mm starkem und 10 mm langem Ohrsteckerstift.

Das Anlöten der Ohrsteckerstifts außerhalb der Mitte bei den größeren Fassungen sorgt für ein angenehmes Tragen des Ohrsteckers sowie für eine bessere Optik am Ohr.

Ohrstecker mit ovaler Fassungen und Ohrmutter 25B Ear studs with oval setting and ear nut 25B							
Steingröße in mm ca.	8,0 x 6,0	10,1 x 8,2	12,0 x 10,0	14,0 x 10,0	16,0 x 12,0	17,8 x 13,0	18,5 x 10,0
Höhe mm ca.	1,2	1,4	1,5	1,5	1,4	1,6	2,7
Artikel-Nr.	68A/8	68A/10	68A/12	68A/14	68A/16	68A/17	68A/18
935 Silber 1 St.	•	•	•	•	•	•	•
935 Silber 10 St.	•	•	•	•	•	•	•

Ohrstecker mit ovaler Fassungen und Ohrmutter 25B Ear studs with oval setting and ear nut 25B							
Steingröße in mm ca.	8,0 x 6,0	10,1 x 8,2	12,0 x 10,0	14,0 x 10,0	16,0 x 12,0	17,8 x 13,0	18,5 x 10,0
Höhe mm ca.	1,2	1,4	1,5	1,5	1,4	1,6	2,7
Artikel-Nr. <i>mit offener Öse</i>	68B/8	68B/10	68B/12	68B/14	68B/16	68B/17	68B/18
Artikel-Nr. <i>mit geschlossener Öse</i>	68C/8	68C/10	68C/12	68C/14	68C/16	68C/17	68C/18
935 Silber 1 St.	•	•	•	•	•	•	•
935 Silber 10 St.	•	•	•	•	•	•	•



Creolen Rohr-Ø 1,3 mm Ear hoops Tube-Ø 1,3 mm				
Außen Ø in mm ca.	11	13	15	17,5
Rohr Ø in mm ca.	1,3	1,3	1,3	1,3
Artikel-Nr.	711	713	715	718
925 Silber 1 St.	•	•	•	•
925 Silber 10 St.	•	•	•	•
585 GG 1 St.	•	•	•	•
750 GG 1 St.	•	•	•	•

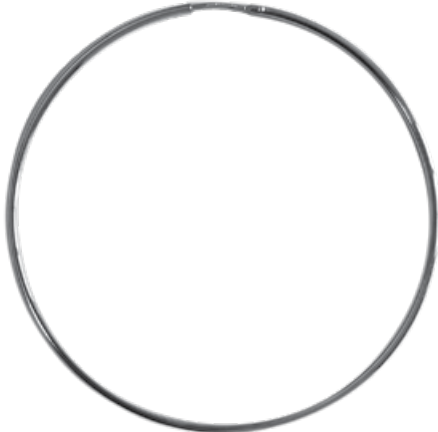
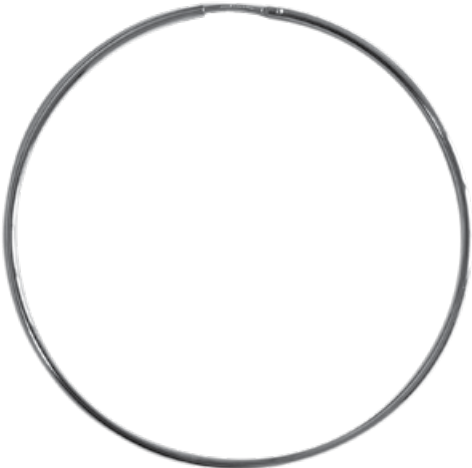

Creolen Rohr-Ø 1,5 mm Ear hoops Tube-Ø 1,5 mm				
Außen Ø in mm ca.	20	25	32	44
Rohr Ø in mm ca.	1,5	1,5	1,5	1,5
Artikel-Nr.	720	725	732	744
925 Silber 1 St.	•	•	•	•
925 Silber 10 St.	•	•	•	•
585 GG 1 St.	•	•	•	•
750 GG 1 St.	•	•	•	•



Creolen Rohr-Ø 1,5 mm Ear hoops Tube-Ø 1,5 mm		
Außen Ø in mm ca.	57	62
Rohr Ø in mm ca.	1,5	1,5
Artikel-Nr.	757	762
925 Silber 1 St.	•	•
925 Silber 10 St.	•	•



SUMA FURNITUREN



Mulde 10 D-75239 Eisingen • ☎ +49 (0) 7232 809 454 • 📠 +49 (0) 7232 809 453 • ✉ info@sumafurnituren.de • www.sumafurnituren.de

Creolen Rohr-Ø 2,0 mm Ear hoops Tube-Ø 2,0 mm			
Außen Ø in mm ca.	13	15	20
Rohr Ø in mm ca.	2,0	2,0	2,0
Artikel-Nr.	713/2	715/2	720/2
925 Silber 1 St.	•	•	•
925 Silber 10 St.	•	•	•
585 GG 1 St.	•	•	•

Creolen Rohr-Ø 2,0 mm Ear hoops Tube-Ø 2,0 mm			
Außen Ø in mm ca.	30	40	50
Rohr Ø in mm ca.	2,0	2,0	2,0
Artikel-Nr.	730/2	740/2	750/2
925 Silber 1 St.	•	•	•
925 Silber 10 St.	•	•	•
585 GG 1 St.	•	•	
585 WG 1 St.	•		





<p>Creolen Rohr-Ø 2,5 mm Ear hoops Tube-Ø 2,5 mm</p>		
Außen Ø in mm ca.	20	30
Rohr Ø in mm ca.	2,5	2,5
Artikel-Nr.	720/2,5	730/2,5
925 Silber 1 St.	•	•
925 Silber 10 St.	•	•
585 GG 1 St.		•
750 GG 1 St.		•



<p>Creolen Rohr-Ø 2,5 mm Ear hoops Tube-Ø 2,5 mm</p>		
Außen Ø in mm ca.	40	50
Rohr Ø in mm ca.	2,5	2,5
Artikel-Nr.	740/2,5	750/2,5
925 Silber 1 St.	•	•
925 Silber 10 St.	•	•







<p>Creolen Rohr-Ø 3,0 mm Ear hoops Tube-Ø 3,0 mm</p>		
Außen Ø in mm ca.	30	40
Rohr Ø in mm ca.	3,0	3,0
Artikel-Nr.	730/3	740/3
925 Silber 1 St.	•	•
925 Silber 10 St.	•	•





SUMA FURNITUREN



Mulde 10 D-75239 Eisingen • ☎ +49 (0) 7232 809 454 • 📠 +49 (0) 7232 809 453 • ✉ info@sumafurnituren.de • www.sumafurnituren.de

Ohrhaken mit Öse, Drahtbrisuren Ear hooks with ring, Earring findings				
Länge x Ø in mm ca.	20,5 x 0,75	23,5 x 0,80	21,5 x 0,70	15,0 x 0,7
	mit Spirale	mit Spirale	mit Spirale und Kugel	
Artikel-Nr.	3611	3613	3615	12C
925 Silber 1 St.	•	•	•	•
925 Silber 10 St.	•	•	•	•
925 Silber 100 St.	•	•	•	•
925 Silber VG 1 St.	•	•	•	
925 Silber VG 10 St.	•	•	•	
925 Silber VG 100 St.	•	•	•	

Ohrhaken (ca. Ø 0,90 mm) Ear hooks				
Ohrhakenlänge in mm ca.	18	18	30	
Artikel-Nr.	124A	127A	124C	
935 Silber 1 St.	•	•	•	
935 Silber 10 St.	•	•	•	
935 Silber 100 St.	•	•	•	
585 GG 1 St.	•	•	•	
585 WG Pd 1 St.	•	•	•	
750 GG 1 St.	•	•	•	
750 WG Pd 1 St.	•	•	•	

Ohrhaken (ca. Ø 0,90 mm) mit Perlschale Ear hooks (ca. Ø 0,90 mm) for pearls							
Perlschalen-Ø in mm ca.	3	4	5	3	4	5	4
Ohrhakenlänge in mm ca.	18	18	18	18	18	18	30
Artikel-Nr.	124/3	124/4	124/5	127/3	127/4	127/5	124C/4
935 Silber 1 St.	•	•	•	•	•	•	•
935 Silber 10 St.	•	•	•	•	•	•	•
935 Silber 100 St.	•	•	•	•	•	•	•
585 GG 1 St.	•	•	•	•	•	•	•
585 WG Pd RH 1 St.	•	•	•	•	•	•	
750 GG 1 St.	•	•	•	•	•	•	•

Ohrhaken (ca. Ø 0,90 mm) mit angelöteter Öse Ear hooks (ca. Ø 0,90 mm) with soldered ring				
Ohrhakenlänge in mm ca.	18	18	18	18
	Öse offen /open ring	Öse geschlossen / closed ring	Queröse offen /open ring	Queröse geschlossen / closed ring
Artikel-Nr.	128	128B	129	129B
935 Silber 1 St.	•	•	•	•
935 Silber 10 St.	•	•	•	•
935 Silber 100 St.	•	•	•	•
585 GG 1 St.	•	•	•	•
585 WG Pd RH 1 St.	•	•	•	•
750 GG 1 St.	•	•	•	•
750 WG Pd RH 1 St.	•	•	•	60,60

Ohrhaken mit gebogener Öse (ca. Ø 0,90 mm) Ear hooks with ring				
Ohrhakenlänge in mm ca.	18	30	30	
Artikel-Nr.	125	125C	125E	
935 Silber 1 St.	•	•	•	
935 Silber 10 St.	•	•	•	
935 Silber 100 St.	•	•	•	
585 GG 1 St.	•	•	•	
585 WG Pd 1 St.	•	•		
750 GG 1 St.	•	•	•	
750 WG Pd 1 St.	•	•		













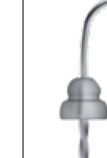

Passende Perlschalenanhänger finden Sie ab Seite 75.









SUMA FURNITUREN

Mulde 10 D-75239 Eisingen • ☎ +49 (0) 7232 809 454 • 📠 +49 (0) 7232 809 453 • ✉ info@sumafurnituren.de • www.sumafurnituren.de

Ohrhaken (ca. Ø 0,90 mm) mit Perlkappen Ear hooks (ca. Ø 0,90 mm) for pearls						
Perlschalen-Ø in mm	3,0	4,0	3,0	4,0	5,0	6,0
Ohrhakenlänge in mm ca.	18,0	18,0	18,0	18,0	18,0	18,0
Artikel-Nr.	130A/3	130A/4	130B/3	130B/4	130B/5	130B/6
935 Silber 1 St.	•	•	•	•	•	•
935 Silber 10 St.	•	•	•	•	•	•
585 GG 1 St.	•	•	•	•	•	•
585 WG Pd 1 St.	•	•	•	•	•	•
750 GG 1 St.	•	•	•	•	•	•

Ohrhaken (ca. Ø 0,90 mm) mit Perlkappen Ear hooks (ca. Ø 0,90 mm) for pearls							
Perlschalen-Ø in mm	3,0	4,0	5,0	6,0	3,0	4,0	3,0
Ohrhakenlänge in mm ca.	18,0	18,0	18,0	18,0	18,0	18,0	18,0
Artikel-Nr.	130C/3	130C/4	130C/5	130C/6	133A/3	133A/4	133B/3
935 Silber 1 St.	•	•	•	•	•	•	•
935 Silber 10 St.	•	•	•	•	•	•	•
585 GG 1 St.	•	•	•	•	•	•	•
585 WG Pd 1 St.	•	•	•	•	•	•	•
750 GG 1 St.	•	•	•	•	•	•	•

Ohrhaken (ca. Ø 0,90 mm) mit angelöteter Öse und Perlkappenanhänger Ear hooks (ca. Ø 0,90 mm) for pearls with soldered rings and pendant							
Perlschalen-Ø in mm	4,0	5,0	6,0	3,0	4,0	5,0	6,0
Ohrhakenlänge in mm ca.	18,0	18,0	18,0	18,0	18,0	18,0	18,0
Artikel-Nr.	133B/4	133B/5	133B/6	133C/3	133C/4	133C/5	133C/6
935 Silber 1 St.	•	•	•	•	•	•	•
935 Silber 10 St.	•	•	•	•	•	•	•
585 GG 1 St.	•	•	•	•	•	•	•
585 WG Pd 1 St.	•	•	•	•	•	•	•
750 GG 1 St.	•	•	•	•	•	•	•



127S/3
Tulpe mit Stift



127T/3
Tulpe ohne Stift



127T/10
Tulpe ohne Stift



127T/23
Tulpe ohne Stift

Ohrhaken (ca. Ø 0,90 mm) mit Tulpe Ear hooks (ca. Ø 0,90 mm) with tulip						
Außen-Ø x Höhe mm ca.	5,0 x 5,0	5,5 x 4,3	6,4 x 5,3	5,6 x 4,6	10,4 x 6,6	5,2 x 4,6
Artikel-Nr. mit Stift	127S/2	127S/3	127S/10	127S/22	127S/23	127S/27
Artikel-Nr. ohne Stift	127T/2	127T/3	127T/10	127T/22	127T/23	127T/27
935 Silber 1 St.	•	•	•	•	•	•
935 Silber 10 St.	•	•	•	•	•	•



In Gold auf Anfrage!

Weitere Tulpen und Tulpenanhänger können auf Anfrage auch gerne geliefert werden. Alle Modelle finden Sie ab Seite 82.
Optionally further tulips and tulip pendants can be supplied. All models you can see on page 82.



128S/3
Tulpe mit Stift



128T/3
Tulpe ohne Stift



128T/22
Tulpe ohne Stift



128S/27
Tulpe mit Stift

Ohrhaken (ca. Ø 0,90 mm) mit Öse und Tulpe Ear hooks (ca. Ø 0,90 mm) with ring and tulip						
Außen-Ø x Höhe mm ca.	5,0 x 5,0	5,5 x 4,3	6,4 x 5,3	5,6 x 4,6	10,4 x 6,6	5,2 x 4,6
Artikel-Nr. mit Stift	128S/2	128S/3	128S/10	128S/22	128S/23	128S/27
Artikel-Nr. ohne Stift	128T/2	128T/3	128T/10	128T/22	128T/23	128T/27
935 Silber 1 St.	•	•	•	•	•	•
935 Silber 10 St.	•	•	•	•	•	•

SUMA FURNITUREN

Mulde 10 D-75239 Eisingen • ☎ +49 (0) 7232 809 454 • 📠 +49 (0) 7232 809 453 • ✉ info@sumafurnituren.de • www.sumafurnituren.de



127F/9,1



127F/12
Seitenansicht



127F/15



127G/18

Ohrhaken (ca. Ø 0,90 mm) mit runder Fassung Ear hooks (ca. Ø 0,90 mm) with round setting							
Steingröße in mm ca.	6,3	7,1	7,5	8,2	8,7	9,1	9,5
Außen-Ø x Höhe mm ca.	6,7 x 1,8	7,5 x 2,0	8,0 x 1,6	8,6 x 1,7	9,2 x 1,8	9,6 x 2,5	9,9 x 3,5
Artikel-Nr.	127F/6,3	127F/7,1	127F/7,5	127F/8,2	127F/8,7	127F/9,1	127F/9,5
935 Silber 1 St.	•	•	•	•	•	•	•
935 Silber 10 St.	•	•	•	•	•	•	•
935 Silber 100 St.	•	•	•	•	•	•	•

Ohrhaken (ca. Ø 0,90 mm) mit runder Fassung Ear hooks (ca. Ø 0,90 mm) with round setting						
Steingröße in mm ca.	10,0	10,5	11,0	12,0	13,1	15,0
Außen-Ø x Höhe mm ca.	10,6 x 1,8	10,9 x 1,9	11,5 x 2,1	12,4 x 2,3	13,5 x 1,6	15,4 x 3,4
Artikel-Nr.	127F/10	127F/10,5	127F/11	127F/12	127F/13	127F/15
935 Silber 1 St.	•	•	•	•	•	•
935 Silber 10 St.	•	•	•	•	•	•
935 Silber 100 St.	•	•	•	•	•	•

Ohrhaken (ca. Ø 0,90 mm) mit ovaler Fassung Ear hooks (ca. Ø 0,90 mm) with oval setting							
Steingröße in mm ca.	8,0 x 6,0	10,1 x 8,2	12,0 x 10,0	14,0 x 10,0	16,0 x 12,0	17,8 x 13,0	18,5 x 10,0
Randhöhe mm ca.	1,2	1,4	1,5	1,5	1,4	1,6	2,7
Artikel-Nr.	127G/8	127G/10	127G/12	127G/14	127G/16	127G/17	127G/18
935 Silber 1 St.	•	•	•	•	•	•	•
935 Silber 10 St.	•	•	•	•	•	•	•
935 Silber 100 St.	•	•	•	•	•	•	•



125F/9,1
Seitenansicht



Ohrhaken (ca. Ø 0,90 mm) mit rundem Fassungsanhänger Ear hooks (ca. Ø 0,90 mm) with pendant of round setting							
Steingröße in mm ca.	6,3	7,1	7,5	8,2	8,7	9,1	9,5
Außen-Ø x Höhe mm ca.	6,7 x 1,8	7,5 x 2,0	8,0 x 1,6	8,6 x 1,7	9,2 x 1,8	9,6 x 2,5	9,9 x 3,5
Artikel-Nr.	125F/6,3	125F/7,1	125F/7,5	125F/8,2	125F/8,7	125F/9,1	125F/9,5
935 Silber 1 St.	•	•	•	•	•	•	•
935 Silber 10 St.	•	•	•	•	•	•	•
935 Silber 100 St.	•	•	•	•	•	•	•

Ohrhaken (ca. Ø 0,90 mm) mit rundem Fassungsanhänger Ear hooks (ca. Ø 0,90 mm) with pendant of round setting						
Steingröße in mm ca.	10,0	10,5	11,0	12,0	13,1	15,0
Außen-Ø x Höhe mm ca.	10,6 x 1,8	10,9 x 1,9	11,5 x 2,1	12,4 x 2,3	13,5 x 1,6	15,4 x 3,4
Artikel-Nr.	125F/10	125F/10,5	125F/11	125F/12	125F/13	125F/15
935 Silber 1 St.	•	•	•	•	•	•
935 Silber 10 St.	•	•	•	•	•	•
935 Silber 100 St.	•	•	•	•	•	•

Ohrhaken (ca. Ø 0,90 mm) mit ovalem Fassungsanhänger Ear hooks (ca. Ø 0,90 mm) with pendant of oval setting							
Steingröße in mm ca.	8,0 x 6,0	10,1 x 8,2	12,0 x 10,0	14,0 x 10,0	16,0 x 12,0	17,8 x 13,0	18,5 x 10,0
Höhe mm ca.	1,2	1,4	1,5	1,5	1,4	1,6	2,7
Artikel-Nr.	125G/8	125G/10	125G/12	125G/14	125G/16	125G/17	125G/18
935 Silber 1 St.	•	•	•	•	•	•	•
935 Silber 10 St.	•	•	•	•	•	•	•
935 Silber 100 St.	•	•	•	•	•	•	•

SUMA FURNITUREN

Mulde 10 D-75239 Eisingen • ☎ +49 (0) 7232 809 454 • 📠 +49 (0) 7232 809 453 • ✉ info@sumafurnituren.de • www.sumafurnituren.de











128F/9,5
Seitenansicht

Ohrhaken (ca. Ø 0,90 mm) mit rundem Fassungsanhänger Ear hooks (ca. Ø 0,90 mm) with pendant of round setting							
Steingröße in mm ca.	6,3	7,1	7,5	8,2	8,7	9,1	9,5
Außen-Ø x Höhe mm ca.	6,7 x 1,8	7,5 x 2,0	8,0 x 1,6	8,6 x 1,7	9,2 x 1,8	9,6 x 2,5	9,9 x 3,5
Artikel-Nr.	128F/6,3	128F/7,1	128F/7,5	128F/8,2	128F/8,7	128F/9,1	128F/9,5
935 Silber 1 St.	•	•	•	•	•	•	•
935 Silber 10 St.	•	•	•	•	•	•	•
935 Silber 100 St.	•	•	•	•	•	•	•

Ohrhaken (ca. Ø 0,90 mm) mit rundem Fassungsanhänger Ear hooks (ca. Ø 0,90 mm) with pendant of round setting						
Steingröße in mm ca.	10,0	10,5	11,0	12,0	13,1	15,0
Außen-Ø x Höhe mm ca.	10,6 x 1,8	10,9 x 1,9	11,5 x 2,1	12,4 x 2,3	13,5 x 1,6	15,4 x 3,4
Artikel-Nr.	128F/10	128F/10,5	128F/11	128F/12	128F/13	128F/15
935 Silber 1 St.	•	•	•	•	•	•
935 Silber 10 St.	•	•	•	•	•	•
935 Silber 100 St.	•	•	•	•	•	•





Ohrhaken (ca. Ø 0,90 mm) mit ovalem Fassungsanhänger Ear hooks (ca. Ø 0,90 mm) with pendant of oval setting							
Steingröße in mm ca.	8,0 x 6,0	10,1 x 8,2	12,0 x 10,0	14,0 x 10,0	16,0 x 12,0	17,8 x 13,0	18,5 x 10,0
Höhe mm ca.	1,2	1,4	1,5	1,5	1,4	1,6	2,7
Artikel-Nr.	128G/8	128G/10	128G/12	128G/14	128G/16	128G/17	128G/18
935 Silber 1 St.	•	•	•	•	•	•	•
935 Silber 10 St.	•	•	•	•	•	•	•
935 Silber 100 St.	•	•	•	•	•	•	•





Karabiner gewölbt mit Öse, gestanzte Ausführung Clasps with ring, stamped version					
Länge x Breite in mm ca.	8,0 x 3,7	9,5 x 4,5	11,5 x 5,9	13,0 x 7,2	16,0 x 8,6
Artikel-Nr.	215/8	215/9	215/11	215/13	215/16
925 Silber 1 St.	•	•	•	•	•
925 Silber 10 St.	•	•	•	•	•
925 Silber 100 St.	•	•	•	•	•
333 GG 1 St.	•	•	•	•	•
333 GG 10 St.	•	•	•	•	
585 GG 1 St.	•	•	•	•	•
585 GG 10 St.	•	•	•	•	
585 RotG 1 St.	•	•	•	•	
585 WG 1 St.	•	•	•	•	
585 WG RH 1 St.	•	•	•	•	
750 GG 1 St.	•	•	•	•	•
750 RotG 1 St.	•	•	•	•	
750 WG 1 St.	•	•	•	•	
750 WG RH 1 St.	•	•	•	•	
950 Platin 1 St.	•	•	•		
Double 1 St.		•	•	•	•
Double 10 St.		•	•	•	•
Double 100 St.		•	•	•	•



Karabiner, flach, gestanzte Ausführung Clasps, flat, stamped version				
Länge x Breite in mm ca.	10	12	14	
Artikel-Nr.	219/10	219/12	219/14	
925 Silber 1 St.	•	•	•	
925 Silber 10 St.	•	•	•	
925 Silber 100 St.	•	•	•	









SUMA FURNITUREN



Mulde 10 D-75239 Eisingen ● ☎ +49 (0) 7232 809 454 ● 📠 +49 (0) 7232 809 453 ● ✉ info@sumafurnituren.de ● www.sumafurnituren.de





Karabiner, flach, gestanzte Ausführung Clasps, flat, stamped version					
Länge x Breite in mm ca.	7,0 x 4,1	8,0 x 4,5	10,0 x 6,0	12,0 x 7,0	14,5 x 8,6
Artikel-Nr.	217/7	217/8	217/10	217/12	217/15
925 Silber 1 St.	•	•	•	•	•
925 Silber 10 St.	•	•	•	•	•
925 Silber 100 St.	•	•	•	•	•
925 Silber 250 St.	•	•	•	•	•
333 GG 1 St.		•	•	•	•
333 GG 10 St.		•	•	•	•
585 GG 1 St.	•	•	•	•	•
585 GG 10 St.	•	•	•	•	
585 WG 1 St.		•	•	•	
585 WG RH 1 St.		•	•	•	
750 GG 1 St.	•	•	•	•	•

Karabiner, flach mit eingehängter Öse, gestanzte Ausführung Clasps, flat with ring, stamped version					
Länge x Breite in mm ca.	7,0 x 4,1 (ohne Öse)	8,0 x 4,5 (ohne Öse)	10,0 x 6,0 (ohne Öse)	12,0 x 7,0 (ohne Öse)	14,5 x 8,6 (ohne Öse)
Artikel-Nr.	217R/7	217R/8	217R/10	217R/12	217R/15
925 Silber 1 St.		•	•	•	•
925 Silber 10 St.		•	•	•	•
925 Silber 100 St.		•	•	•	•
925 Silber 250 St.		•	•	•	•
585 GG 1 St.		•	•	•	
585 GG 10 St.		•	•	•	
585 WG 1 St.	•	•	•		
585 WG RH 1 St.	•	•	•		
750 GG 1 St.		•	•		
750 WG 1 St.		•			
750 WG RH 1 St.		•			

Karabiner, flach mit eingehängter Öse, gestanzte Ausführung Clasps, flat with ring, stamped version				
Länge x Breite in mm ca.	8,3 x 4,5 (ohne Öse)	9,0 x 5,0 (ohne Öse)	16,0 x 8,6 (ohne Öse)	
Artikel-Nr.	217R/8B	217R/9	217R/16	
925 Silber 1 St.	•	•	•	
925 Silber 10 St.	•	•	•	
925 Silber 100 St.	•	•	•	
925 Silber 250 St.	•	•		

Karabiner, flach, gestanzte Ausführung Clasps, flat, stamped version								
Länge in mm ca.	7	8	10	12	14	16	16	18
Breite in mm ca.	2,7	3,2	3,8	4,3	5,2	6,2	8,0	9,0
Artikel-Nr.	218/7	218/8	218/10	218/12	218/14	218/16	218/16B	218/18
925 Silber 1 St.		•	•	•	•	•	•	•
925 Silber 10 St.		•	•	•	•	•	•	•
925 Silber 100 St.		•	•	•	•	•		
925 Silber 250 St.		•	•	•	•			
333 GG 1 St.		•	•	•	•	•		
333 GG 10 St.		•	•	•	•			
585 GG 1 St.	•	•	•	•	•	•		•
585 GG 10 St.	•	•	•	•	•			
585 RotG 1 St.		•	•	•				
585 WG 1 St.		•	•	•	•			
585 WG RH 1 St.		•	•	•	•			
750 GG 1 St.	•	•	•	•	•			
750 RotG 1 St.		•	•	•				
750 WG 1 St.		•	•	•				
750 WG RH 1 St.		•	•	•				
950 Platin 1 St.		•	•					

Karabiner, flach, gestanzte, <u>leichte</u> Aus- führung Clasps, flat, stamped, <u>light</u> version				
Länge x Breite in mm ca.	10,0 x 3,8	12,0 x 4,3	14,0 x 5,2	
Artikel-Nr.	218L/10	218L/12	218L/14	
585 GG 1 St.	•	•		
750 GG 1 St.	•		•	

Karabiner, flach mit eingehängter Öse, gestanzte Ausführung Clasps, flat with ring, stamped version				
Länge x Breite in mm ca.	10,0 x 3,8 (ohne Öse)	12,0 x 4,3 (ohne Öse)	14,0 x 5,2 (ohne Öse)	16,0 x 6,2 (ohne Öse)
Artikel-Nr.	218R/10	218R/12	218R/14	218R/16
925 Silber 1 St.	•	•	•	•
925 Silber 10 St.	•	•	•	•
925 Silber 100 St.	•	•	•	•
925 Silber 250 St.	•	•	•	

Gusskarabiner - Premium-Qualität

gewölbter, bauchiger Karabiner

neues Modell







Bügel und Öse in stabiler, kräftiger Ausführung

formschönes Design

leicht zu Öffnen durch gut geformten Schnepper

herausragende Premium-Qualität



Karabiner gewölbt mit Öse, gegossene Ausführung Trigger clasps with ring, casted version						
Länge in mm ca.	8,2	9	10	11	12	13
Artikel-Nr.	245/8	245/9	245/10	245/11	245/12	245/13
935 Silber 1 St.	•	•	•	•	•	•
935 Silber 10 St.	•	•	•	•	•	•
333 GG 1 St.	•	•	•	•	•	•
585 GG 1 St.	•	•	•	•	•	•
585 RoseG 1 St.		•	•	•		
585 RotG 1 St.	•	•	•	•	•	•
585 WG Pd 1 St.	•	•	•	•	•	•
750 GG 1 St.	•	•	•	•	•	•
750 RoseG 1 St.	•	•	•	•	•	•
750 RotG 1 St.	•	•	•	•	•	•
750 WG Pd 1 St.	•	•	•	•	•	•
950 Platin 1 St.	•	•	•	•	•	•

Karabiner gewölbt mit Öse, gegossene Ausführung Trigger clasps with ring, casted version						
Länge in mm ca.	15	17	20	23		
Artikel-Nr.	245/15	245/17	245/20	245/23		
935 Silber 1 St.	•	•	•	•		
935 Silber 10 St.	•	•	•	•		
585 GG 1 St.	•	•	•	•		
585 RotG 1 St.	•	•				
585 WG Pd 1 St.	•	•				
750 GG 1 St.	•	•				
750 RoseG 1 St.	•	•				
750 RotG 1 St.	•	•				
750 WG Pd 1 St.	•	•				
950 Platin 1 St.	•	•				

Gusskarabiner - Premium-Qualität

gewölbter, bauchiger Karabiner

mit Queröse

neues Modell





Bügel und Öse in stabiler, kräftiger Ausführung

formschönes Design

leicht zu Öffnen durch gut geformten Schnepper

herausragende Premium-Qualität



Karabiner gewölbt mit Öse, gegossene Ausführung Trigger clasps with ring, casted version					
Länge in mm ca.	9	11	13	15	
Artikel-Nr.	246/9	246/11	246/13	246/15	
935 Silber 1 St.	•	•	•	•	
935 Silber 10 St.	•	•	•	•	
333 GG 1 St.	•	•	•	•	
585 GG 1 St.	•	•	•	•	
585 RotG 1 St.	•	•	•	•	
585 WG Pd 1 St.	•	•	•	•	
750 GG 1 St.	•	•	•	•	
750 RoseG 1 St.	•	•	•	•	
750 RotG 1 St.	•	•	•	•	
750 WG Pd 1 St.	•	•	•	•	
950 Platin 1 St.	•	•	•	•	

Gusskarabiner - Premium-Qualität

flacher Karabiner

neues Modell



Bügel und Öse in stabiler, kräftiger Ausführung

formschönes Design

leicht zu Öffnen durch gut geformten Schnepper

herausragende Premium-Qualität



Karabiner flach mit Öse, gegossene Ausführung Trigger clasps, flat with ring, casted version					
Länge in mm ca.	9	11	13		
Artikel-Nr.	243/9	243/11	243/13		
935 Silber 1 St.	•	•	•		
935 Silber 10 St.	•	•	•		
585 GG 1 St.	•	•	•		
585 RotG 1 St.	•	•	•		
585 WG Pd 1 St.	•	•	•		
750 GG 1 St.	•	•	•		
750 RoseG 1 St.	•	•	•		
750 RotG 1 St.	•	•	•		
750 WG Pd 1 St.	•	•	•		

Gusskarabiner - Standard Ausführung





leicht gewölbter Karabiner
formschönes Design



Serie 225



Serie 226

Karabiner gewölbt mit Öse, gegossene Ausführung Trigger clasps with ring, casted version					
Länge in mm ca.	13	15	17	20	
Artikel-Nr.	225/13	225/15	225/17	225/20	
333 GG 1 St.	•	•	•	•	
585 GG 1 St.	•	•	•	•	
585 RotG 1 St.	•	•	•	•	
590 WG Pd 1 St.	•	•	•	•	
750 GG 1 St.	•	•	•	•	
750 RoseG 1 St.	•	•	•	•	
750 RotG 1 St.	•	•	•	•	
750 WG Pd 1 St.	•	•	•	•	
950 Platin 1 St.	•	•	•	•	

Karabiner gewölbt mit Queröse, gegossene Ausführung Trigger clasps with ring, casted version					
Länge in mm ca.	13	15	17	20	
Artikel-Nr.	226/13	226/15	226/17	226/20	
935 Silber 1 St.			•	•	
333 GG 1 St.	•	•	•	•	
585 GG 1 St.	•	•	•	•	
585 RotG 1 St.	•	•	•	•	
590 WG Pd 1 St.	•	•	•	•	
750 GG 1 St.	•	•	•	•	
750 RoseG 1 St.	•	•	•	•	
750 RotG 1 St.	•	•	•	•	
750 WG Pd 1 St.	•	•	•	•	
950 Platin 1 St.	•	•	•	•	

Gusskarabiner - Standard-Ausführung



leicht gewölbter Karabiner
bewährtes Design







leicht gewölbter Karabiner
bewährtes Design
mit Queröse



Karabiner Clasps					
Länge in mm ca.	9	11	13	15	
Artikel-Nr.	235/9	235/11	235/13	235/15	235/17
935 Silber 1 St.	•	•	•	•	•
935 Silber 10 St.	•	•	•	•	•
935 Silber 100 St.	•	•	•	•	
333 GG 1 St.	•	•	•		
585 GG 1 St.	•	•	•	•	
585 WG rhod. 1 St.	•	•	•		
750 GG 1 St.	•	•	•		
750 WG rhod. 1 St.	•	•	•		







Karabiner gewölbt mit Öse, gegossene Ausführung Trigger clasps with ring, casted version					
Länge in mm ca.	20	23	30		
Artikel-Nr.	235/20	235/23	235/30		
935 Silber 1 St.	•	•	•		
935 Silber 10 St.	•	•	•		
333 GG 1 St.		•			
585 GG 1 St.		•			
750 GG 1 St.		•			

Karabiner gewölbt mit Queröse, gegossene Ausführung Trigger clasps with ring, casted version						
Länge in mm ca.	9	11	13	15		
Artikel-Nr.	236/9	236/11	236/13	236/15		
935 Silber 1 St.	•	•	•	•		
935 Silber 10 St.	•	•	•	•		
935 Silber 100 St.	•	•	•	•		
333 GG 1 St.	•	•	•			
585 GG 1 St.	•	•	•			
750 GG 1 St.	•	•	•			

Gusskarabiner - Standard-Ausführung

flacher Karabiner
bewährtes Design











Karabiner Clasps							
Länge in mm ca.	7,5	8,5	10	11	12	13	15
Artikel-Nr.	233/7,5	233/8,5	233/10	233/11	233/12	233/13	233/15
935 Silber 1 St.	•	•	•	•	•	•	•
935 Silber 10 St.	•	•	•	•	•	•	•
935 Silber 100 St.	•	•	•	•	•	•	•
333 GG 1 St.	•	•	•	•			
585 GG 1 St.	•	•	•	•	•		
585 WG rhod. 1 St.	•	•	•	•			
750 GG 1 St.	•	•	•	•	•		
750 WG rhod. 1 St.	•	•	•	•			





Gusskarabiner - Standard-Ausführung



flacher, länglicher Karabiner
bewährtes Design



Karabiner Clasps						
Länge in mm ca.	12	14	16	18	22	26
Artikel-Nr.	232/12	232/14	232/16	232/18	232/22	232/26
935 Silber 1 St.	•	•	•	•	•	•
935 Silber 10 St.	•	•	•	•	•	•





Karabiner mit Doppelzierbund, gegossene Ausführung Trigger clasps with band, casted version					
Länge in mm ca.	13	15	17	20	23,5
Artikel-Nr.	214/13	214/15	214/17	214/20	214/23
935 Silber 1 St.	•	•	•	•	•
935 Silber 10 St.	•	•	•	•	•
585 GG 1 St.	•	•	•	•	•
585 RotG 1 St.	•	•	•	•	•
590 WG Pd 1 St.	•	•	•	•	•
750 GG 1 St.	•	•	•	•	•
750 RotG 1 St.	•	•	•	•	•
750 WG Pd 1 St.	•	•	•	•	•

Karabiner mit Doppelzierbund und Queröse, gegossene Ausführung Trigger clasps with band, casted version					
Länge in mm ca.	13	15	17	20	22
Artikel-Nr.	214Q/13	214Q/15	214Q/17	214Q/20	214Q/22
935 Silber 1 St.	•	•	•	•	•
935 Silber 10 St.	•	•	•	•	•
585 GG 1 St.	•	•	•	•	•
585 RotG 1 St.	•	•	•	•	•
590 WG Pd 1 St.	•	•	•	•	•
750 GG 1 St.	•	•	•	•	•
750 RotG 1 St.	•	•	•	•	•
750 WG Pd 1 St.	•	•	•	•	•



Karabiner mit offener Öse Clasps with open ring					
Länge in mm ca.	12	16			
Artikel-Nr.	325/12	325/16			
935 Silber 1 St.	•	•			
935 Silber 10 St.	•	•			





SUMA FURNITUREN



Mulde 10 D-75239 Eisingen • ☎ +49 (0) 7232 809 454 • 📠 +49 (0) 7232 809 453 • ✉ info@sumafurnituren.de • www.sumafurnituren.de



Karabiner, Achterform - leichte Ausführung Clasps „form 8“ - light weight					
Länge in mm ca.	12	14	16	19	
Artikel-Nr.	223/12	223/14	223/16	223/19	
935 Silber 1 St.	•	•	•	•	
935 Silber 10 St.	•	•	•	•	





Karabiner, Achterform - schwere Ausführung Clasps „form 8“ - heavy version					
Länge in mm ca.	13	15	17	20	22
Artikel-Nr.	223/13	223/15	223/17	223/20	223/22
935 Silber 1 St.	•	•	•	•	•
935 Silber 10 St.	•	•	•	•	•
585 GG 1 St.	•	•	•	•	•
585 RotG 1 St.	•				
590 WG Pd 1 St.	•	•	•	•	•
750 GG 1 St.	•	•	•	•	•
750 RoseG 1 St.	•	•			
750 RotG 1 St.	•	•			
750 WG Pd 1 St.	•	•	•	•	•
950 Platin 1 St.	•				

Karabiner, Achterform mit Kappen und Quer- steg Clasps „form 8“ with caps and bar					
Karabiner-Länge mm ca.	13	15	17		
Kappen Innen-Ø in mm	5	5	5		
Artikel-Nr.	353A/13	353A/15	353A/17		
935 Silber 1 St.	•	•	•		

Karabiner, rund Clasps, round				
Breite in mm ca.	7,0	10,0	10,0	11,5
Artikel-Nr.	213/7	213/10	213Q/10	213/11
925 Silber 1 St.	•	•	•	•
925 Silber 10 St.	•	•	•	•
585 GG 1 St.	•	•	•	•
585 RotG 1 St.		•	•	•
590 WG Pd 1 St.		•	•	•
750 GG 1 St.	•	•	•	•
750 RotG 1 St.		•	•	•
750 WG Pd 1 St.		•	•	•



Karabiner, rund Clasps, round				
Länge x Breite in mm ca.	8,0 x 5,8	9,5 x 6,7	12,1 x 8,0	
Artikel-Nr.	357/8	357/10	357/12	
925 Silber 1 St.	•	•	•	
925 Silber 10 St.	•	•	•	
585 GG 1 St.	•	•	•	
750 GG 1 St.	•	•	•	

Karabiner, Herz Clasps, heart shape				
Maße in mm ca.	9	11		
Artikel-Nr.	347/9	347/11		
935 Silber 1 St.	•	•		
935 Silber 10 St.	•	•		

Karabiner, navette Clasps, navette				
Länge x Breite in mm ca.	11,3 x 5,8	13,2 x 7,2	14,9 x 9,9	17,0 x 10,9
Artikel-Nr.	355/12	355/14	355/15	355/17
935 Silber 1 St.	•	•	•	•
935 Silber 10 St.	•	•	•	•





SUMA FURNITUREN

Mulde 10 D-75239 Eisingen • ☎ +49 (0) 7232 809 454 • 📠 +49 (0) 7232 809 453 • ✉ info@sumafurnituren.de • www.sumafurnituren.de

Collierschließe, Collierschließe mit Kappen und Steg Clasps			
Länge x Breite in mm ca.	25,0 x 10,7	17,0 x 8,0	17,2 x 7,5
Artikel-Nr.	356A	356B	356F
925 Silber 1 St.	•	•	•
925 Silber 10 St.	•	•	•
585 GG 1 St.	•	•	•
585 RotG 1 St.		•	•
585 WG Pd 1 St.			•
750 GG 1 St.	•	•	•
750 RotG 1 St.			•
750 WG Pd 1 St.		•	•









Die Kappe am Karabiner ist drehbar.

Karabiner mit Kappen Clasps with caps				
Gesamtlänge in mm ca.	18,0	19,0	20,0	21,0
Kappen Innen- / Außen- Ø in mm ca.	1,6 / 3,0	2,0 / 3,5	3,0 / 4,0	4,0 / 5,0
Artikel-Nr.	370/3	370/3,5	370/4	370/5
925 Silber 1 St.	•	•	•	•
925 Silber 10 St.	•	•	•	•
585 GG 1 St.	•	•	•	•
750 GG 1 St.	•	•	•	•



- **schwere, stabile Ausführung**
- ausgezeichnete Verarbeitung des Federrings
- offene, starke, angelötete Öse
- hervorragende Goldschmiedequalität

Federringe ohne Bund Spring ring						
Außen-Ø in mm ca.	5,0	5,5	6,0	7,0	8,0	10,0
Rohr-Ø in mm ca.	1,4	1,4	1,4	1,6	1,8	2,2
Abmessung Öse mm ca.	3,2 x 0,7	3,2 x 0,7	3,5 x 0,8	3,9 x 1,0	3,9 x 1,0	4,0 x 1,0
Artikel-Nr.	212/5	212/5,5	212/6	212/7	212/8	212/10
925 Silber 1 St.	•	•	•	•	•	•
925 Silber 10 St.	•	•	•	•	•	•
925 Silber 100 St.	•	•	•	•	•	•
333 GG 1 St.	•	•	•	•	•	
333 GG 10 St.	•	•	•	•	•	
585 GG 1 St.	•	•	•	•	•	•
585 GG 10 St.	•	•	•	•	•	•
585 RotG 1 St.	•	•	•			
585 WG 1 St.	•	•	•	•	•	
585 WG RH 1 St.	•	•	•	•	•	
750 GG 1 St.	•	•	•	•	•	•
750 GG 10 St.	•	•	•	•	•	
750 RoseG 1 St.	•		•	•		
750 RotG 1 St.	•	•	•	•	•	
750 WG 1 St.	•	•	•	•	•	
750 WG RH 1 St.	•	•	•	•	•	
Double 1 St.		•	•	•	•	•
Double 10 St.		•	•	•	•	•
Double 100 St.		•	•	•	•	

SUMA FURNITUREN

Mulde 10 D-75239 Eisingen • ☎ +49 (0) 7232 809 454 • 📠 +49 (0) 7232 809 453 • ✉ info@sumafurnituren.de • www.sumafurnituren.de









- leichte Ausführung
- angelötete Öse
- sehr gute Qualität

212L/5

Federringe ohne Bund Spring ring						
Außen-Ø in mm ca.	4,0	4,5	5,0	5,5	6,0	
Rohr-Ø in mm ca.	0,85	0,85	0,95	1,03	1,1	
Abmessung Öse mm ca.	2,0 x 0,55	2,3 x 0,55	2,55 x 0,55	2,55 x 0,55	2,55 x 0,65	
Artikel-Nr.	212L/4	212L/4,5	212L/5	212L/5,5	212L/6	
750 GG 1 St.	•	•	•	•	•	
750 GG 10 St.	•	•	•	•	•	
750 RotG 1 St.	•	•	•	•	•	
750 RotG 10 St.	•	•	•	•	•	
750 WG 1 St.	•	•	•	•	•	
750 WG 10 St.	•	•	•	•	•	
750 WG RH 1 St.	•	•	•	•	•	
750 WG RH 10 St.	•	•	•	•	•	
950 Platin 1 St.			•			

Federringe ohne Bund, mit flacher Öse Spring ring with flat ring						
Außen-Ø in mm ca.	5,5	6,0	7,0			
Rohr-Ø in mm ca.	1,4	1,4	1,6			
Abmessung Öse mm ca.	3,2 x 0,7	3,5 x 0,8	3,9 x 1,0			
Artikel-Nr.	212F/5,5	212F/6	212F/7			
925 Silber 1 St.	•	•	•			
925 Silber 10 St.	•	•	•			
925 Silber 100 St.	•	•	•			

Federringe mit Bund und starker Öse

Federringe mit Bund und starker Öse Spring ring with strong ring							
Außen-Ø in mm ca.	5,0	5,5	6,0	7,0	8,0	10,0	12,0
Rohr-Ø in mm ca.	1,9	1,9	1,9	1,9	2,0	2,1	2,1
Abmessung Öse mm ca.	2,8 x 0,7	2,8 x 0,7	2,8 x 0,7	3,1 x 0,8	3,5 x 0,9	4,4 x 1,0	5,1 x 1,2
Artikel-Nr.	501/5	501/5,5	501/6	501/7	501/8	501/10	501/12
935 Silber 1 St.	•	•	•	•	•	•	
935 Silber 10 St.	•	•	•	•	•	•	
935 Silber 100 St.	•	•	•	•	•	•	
333 GG 1 St.	•	•	•	•	•		
333 GG 10 St.	•	•	•	•	•		
585 GG 1 St.	•	•	•		•	•	•
585 RotG 1 St.			•				
585 WG RH 1 St.	•	•	•	•	•		
750 GG 1 St.	•	•	•	•	•	•	•
750 RoseG 1 St.	•	•	•	•			
750 RotG 1 St.	•	•	•	•	•		
750 WG RH 1 St.	•	•	•	•	•		



Federringe mit Bund „Made in Germany“

Diese Federringe werden in Deutschland hergestellt und sind von Hand gefertigt. Ihre Merkmale sind das stabile, geschlossene Rohr mit seiner guten Wandung und die starke, offene Öse, welche angelötet ist. Die Leichtgängigkeit des Federrings unterstreicht die hohe Präzisionsarbeit bei diesen Produkten.

Bei Artikel-Nr. 501/... ist die Öse aus Runddraht gefertigt; bei Artikel-Nr. 502/... aus extra-starkem Halbrund-Draht.









Artikel-Nr. 501/8



Artikel-Nr. 502/8







Federringe mit Bund und extra-starker Halbrund-Öse





Federringe mit Bund und extra starker Halbrund-Draht-Öse Spring ring with extra strong ring of halfround-wire						
Außen-Ø in mm ca.	5,5	6,0	7,0	8,0	10,0	12,0
Rohr-Ø in mm ca.	1,9	1,9	1,9	2,0	2,1	2,1
Abmessung Öse mm ca.	2,8	2,8	3,1	3,5	4,4	5,1
Artikel-Nr.	502/5,5	502/6	502/7	502/8	502/10	502/12
935 Silber 1 St.	•	•	•	•	•	
935 Silber 10 St.	•	•	•	•	•	
935 Silber 100 St.	•	•	•	•	•	
585 GG 1 St.	•	•	•	•	•	•
750 GG 1 St.	•	•	•	•	•	•
750 RoseG 1 St.	•	•	•			
750 RotG 1 St.	•	•	•	•		
750 WG 1 St.	•	•	•	•		



SUMA FURNITUREN





Mulde 10 D-75239 Eisingen • ☎ +49 (0) 7232 809 454 • 📠 +49 (0) 7232 809 453 • ✉ info@sumafurnituren.de • www.sumafurnituren.de



Uhrketten-Federring Big Spring ring			
Außen-Ø x Rohr-Ø in mm ca.	18 x 3,0	20 x 3,0	20 x 3,0 mit extra-starker Doppelöse
Artikel-Nr.	218N	218A	218P
925 Silber 1 St.	•	•	•
925 Silber 10 St.	•	•	•
585 GG 1 St.	•	•	
750 GG 1 St.	•	•	
750 RotG 1 St.		•	

Uhrketten-Karabiner, feststehend und drehbar Swivel, fixed and rotatable						
Außen-Ø in mm ca.	18,0	21,0	23,0	19,0	22,0	25,0
	feststehend	feststehend	feststehend	drehbar	drehbar	drehbar
Artikel-Nr.	218B	218C	218D	218E	218F	218G
925 Silber 1 St.	•	•	•	•	•	•
925 Silber 10 St.	•	•	•	•	•	•
585 GG 1 St.	•	•	•	•	•	
750 GG 1 St.	•	•	•	•	•	
750 RotG 1 St.					•	

Große Schmuckfederringe Big Spring ring				
Außen-Ø in mm ca.	12,0	14,0	16,0	16,0
Rohr-Ø in mm ca.	3,0	3,0	3,0	4,0
Artikel-Nr.	9112	9114	9116	9116 B
925 Silber 1 St.	•	•	•	•
925 Silber 10 St.	•	•	•	•
585 GG 1 St.	•	•	•	•
750 GG 1 St.	•	•		•
750 RotG 1 St.	•			

Große Schmuckfederringe Big Spring ring				
Außen-Ø in mm ca.	18,0	18,0	20,0	22,0
Rohr-Ø in mm ca.	3,0	4,0	4,0	4,0
Artikel-Nr.	9118	9118 B	9120	9122
925 Silber 1 St.	•	•	•	•
925 Silber 10 St.	•	•	•	•
585 GG 1 St.	•	•	•	
750 GG 1 St.		•	•	

Große Schmuckfederringe mit zwei Doppelösen Big Spring ring with two double rings				
Außen-Ø in mm ca.	12,0	14,0	16,0	16,0
Rohr-Ø in mm ca.	3,0	3,0	3,0	4,0
Artikel-Nr.	9012	9014	9016	9016 B
925 Silber 1 St.	•	•	•	•
925 Silber 10 St.	•	•	•	•
585 GG 1 St.	•	•	•	
750 GG 1 St.	•	•		

Große Schmuckfederringe mit zwei Doppelösen Big Spring ring with two double rings				
Außen-Ø in mm ca.	18,0	18,0	20,0	22,0
Rohr-Ø in mm ca.	3,0	4,0	4,0	4,0
Artikel-Nr.	9018	9018 B	9020	9022
925 Silber 1 St.	•	•	•	•
925 Silber 10 St.	•	•	•	•
585 GG 1 St.	•			

SUMA FURNITUREN

Mulde 10 D-75239 Eisingen • ☎ +49 (0) 7232 809 454 • 📠 +49 (0) 7232 809 453 • ✉ info@sumafurnituren.de • www.sumafurnituren.de



9318B/6







Für alle Artikel mit Nr. 93.. gilt:
Die Kappen haben alle ein Umfädel-Loch für ein leichteres und
einfaches Auffädeln.



Große Schmuckfeder- ringe 16 mm mit Kappen Big Spring ring 16 mm with caps								
Außen- x Rohr-Ø ca. mm	16,0 x 3,0	16,0 x 4,0	16,0 x 3,0	16,0 x 4,0	16,0 x 3,0	16,0 x 4,0	16,0 x 3,0	16,0 x 4,0
Innen-Ø Kappe mm ca.	4,0 gerieft	6,0 gerieft	4,0 glatt	6,0 glatt	4,0 gerieft	6,0 gerieft	4,0 glatt	6,0 glatt
					mit Quersteg / with bar			
Artikel-Nr.	9216/4	9216B/6	9216/4G	9216B/6G	9316/4	9316B/6	9316/4G	9316B/6G
925 Silber 1 St.	•	•	•	•	•	•	•	•



Große Schmuckfeder- ringe 18 mm mit Kappen Big Spring ring 18 mm with caps								
Außen- x Rohr-Ø ca. mm	18,0 x 4,0	18,0 x 4,0	18,0 x 4,0	18,0 x 4,0	18,0 x 4,0	18,0 x 4,0	18,0 x 4,0	18,0 x 4,0
Innen-Ø Kappe mm ca.	6,0 gerieft	7,5 gerieft	6,0 glatt	7,5 glatt	6,0 gerieft	7,5 gerieft	6,0 glatt	7,5 glatt
					mit Quersteg / with bar			
Artikel-Nr.	9218B/6	9218B/7,5	9218B/6G	9218B/7,5G	9318B/6	9318B/7,5	9318B/6G	9318B/7,5G
925 Silber 1 St.	•	•	•	•	•	•	•	•

Große Schmuckfeder- ringe 20 / 22 mm mit Kappen Big Spring ring 20 / 22 mm with caps								
Außen- x Rohr-Ø ca. mm	20,0 x 4,0	20,0 x 4,0	22,0 x 4,0	22,0 x 4,0	20,0 x 4,0	20,0 x 4,0	22,0 x 4,0	22,0 x 4,0
Innen-Ø Kappe mm ca.	7,5 gerieft	7,5 glatt	7,5 gerieft	7,5 glatt	7,5 gerieft	7,5 glatt	7,5 gerieft	7,5 glatt
					mit Quersteg / with bar			
Artikel-Nr.	9220/7,5	9220/7,5G	9222/7,5	9222/7,5G	9320/7,5	9320/7,5G	9322/7,5	9322/7,5G
925 Silber 1 St.	•	•	•	•	•	•	•	•

Große Schmuckfeder- ringe 16 mm mit fla- chen Kappen Big Spring ring with flat caps				
	Außen-Ø x Rohr-Ø ca.	16,0 x 3,0 mm	16,0 x 4,0 mm	16,0 x 3,0 mm
Innen-Ø Kappe mm ca.	5,9	8,0	5,9 / mit Quersteg	8,0 / mit Quersteg
Artikel-Nr.	9816/6	9816B/8	9916/6	9916B/8
925 Silber 1 St.	•	•	•	•

Große Schmuckfeder- ringe 18 mm mit fla- chen Kappen Big Spring ring with flat caps				
	Außen-Ø x Rohr-Ø ca.	18,0 x 3,0 mm	18,0 x 4,0 mm	18,0 x 3,0 mm
Innen-Ø Kappe mm ca.	5,9	8,0	5,9 / mit Quersteg	8,0 / mit Quersteg
Artikel-Nr.	9818/6	9818B/8	9918/6	9918B/8
925 Silber 1 St.	•	•	•	•

Große Schmuckfeder- ringe 20 mm mit fla- chen Kappen Big Spring ring with flat caps				
	Außen-Ø x Rohr-Ø ca.	20,0 x 4,0 mm	20,0 x 4,0 mm	20,0 x 4,0 mm
Innen-Ø Kappe mm ca.	8,0	9,5	8,0 / mit Quersteg	9,5 / mit Quersteg
Artikel-Nr.	9820/8	9820/9	9920/8	9920/9
925 Silber 1 St.	•	•	•	•

Große Schmuckfeder- ringe 22 mm mit fla- chen Kappen Big Spring ring with flat caps				
	Außen-Ø x Rohr-Ø ca.	22,0 x 4,0 mm	22,0 x 4,0 mm	22,0 x 4,0 mm
Innen-Ø Kappe mm ca.	8,0	9,5	8,0 / mit Quersteg	9,5 / mit Quersteg
Artikel-Nr.	9822/8	9822/9	9922/8	9922/9
925 Silber 1 St.	•	•	•	•

SUMA FURNITUREN

Mulde 10 D-75239 Eisingen • ☎ +49 (0) 7232 809 454 • 📠 +49 (0) 7232 809 453 • ✉ info@sumafurnituren.de • www.sumafurnituren.de

Bajonettverschlüsse, Standardlänge Bayonets, standard length							
Bohrung in mm ca.		0,8	1,0	1,3	1,5	2,0	3,0
Außen-Ø x Länge mm ca.		1,8 x 16,5	1,8 x 16,5	1,8 x 16,5	1,8 x 16,5	2,6 x 16,5	3,5 x 17,5
Artikel-Nr.		8008	8010	8013	8015	8020	8030
925 Silber 1 St.						•	•
925 Silber 10 St.						•	•
925 Silber 100 St.						•	•
585 GG 1 St.		•	•	•	•	•	•
585 WG Pd 1 St.			•	•	•	•	•
750 GG 1 St.		•	•	•	•	•	•
750 WG Pd 1 St.		•	•	•	•	•	•

Bajonettverschlüsse, Standardlänge Bayonets, standard length							
Bohrung in mm ca.		4,0	5,0	6,0	7,0	8,0	10,0
Außen-Ø x Länge mm ca.		4,5 x 18,5	5,5 x 18,5	6,5 x 21,5	8,0 x 23,5	9,0 x 24,3	11,0 x 28,5
Artikel-Nr.		8040	8050	8060	8070	8080	8100
925 Silber 1 St.		•	•	•	•	•	•
925 Silber 10 St.		•	•	•	•	•	•
585 GG 1 St.		•	•	•			
585 WG Pd 1 St.		•					
750 GG 1 St.		•	•	•			
750 WG Pd 1 St.		•					

Bajonettverschlüsse, lange Ausführung Bayonets, long version						
Bohrung in mm ca.	0,6	0,8	1,0	1,15	1,3	1,5
Außen-Ø x Länge mm ca.	1,8 x 20,5	1,8 x 20,5	1,8 x 20,5	1,8 x 20,5	1,8 x 20,5	1,8 x 20,5
Artikel-Nr.	8006L	8008L	8010L	8011L	8013L	8015L
925 Silber 1 St.	•	•	•		•	•
925 Silber 10 St.	•	•	•		•	•
925 Silber 100 St.	•	•	•		•	•
585 GG 1 St.	•	•	•		•	
585 WG 1 St.		•	•		•	
Edelstahl 1 St.		•	•	•	•	•
Edelstahl 10 St.		•	•	•	•	•
Edelstahl 100 St.		•	•	•	•	•

Bajonettverschlüsse, lange Ausführung Bayonets, long version						
Bohrung in mm ca.	2,0	2,5	3,0	4,0	5,0	
Außen-Ø x Länge mm ca.	2,6 x 21,5	3,0 x 22,0	3,5 x 22,0	4,5 x 23,5	5,5 x 25,5	
Artikel-Nr.	8020L	8025L	8030L	8040L	8050L	
925 Silber 1 St.	•	•	•	•	•	
925 Silber 10 St.	•	•	•	•	•	
Außen-Ø x Länge mm ca.	2,8 x 22,5		3,5 x 22,5	4,5 x 22,5	5,5 x 25,8	
Artikel-Nr.	8020L		8030L	8040L	8050L	
Edelstahl 1 St.	•		•	•	•	
Edelstahl 10 St.	•		•	•	•	
Edelstahl 100 St.	•		•			



Hebel-Druck-Schließen









Nr. 7912









Nr. 7920





Unsere Hebel-Druck-Schließen erhalten eine durchgehenden Finierachse, die beideseitig vernietet wird.
Auf Wunsch können diese Schließen auch nur gestiftet (nicht finiert) geliefert werden. Bitte bei der Bestellung angeben.





Schließen mit Hebel-Druck-System, rund, gerade Clasps with lever-back-system, round, straight					
Gesamtlänge in mm ca.	23	23	23	23	23
Außen-Ø Kapsel mm ca.	2,4	2,4	2,4	3,2	3,2
Bohrung-Ø x -tiefe mm ca.	1,0 x 4,5	1,2 x 4,5	1,5 x 4,5	1,8 x 4,5	2,0 x 4,5
Artikel-Nr.	7910	7912	7915	7918	7920
935 Silber 1 St.	•	•	•	•	•
935 Silber 10 St.	•	•	•	•	•
585 GG 1 St.	•	•	•	•	•
585 WG Pd 1 St.	•	•	•	•	•
750 GG 1 St.	•	•	•	•	•
750 RotG 1 St.	•	•	•	•	•
750 WG Pd 1 St.	•	•	•	•	•



Schließen mit Hebel-Druck-System, rund, gerade Clasps with lever-back-system, round, straight	
Gesamtlänge in mm ca.	22,0
Außen-Ø Kapsel mm ca.	4,5
Bohrung-Ø x -tiefe mm ca.	3,0 x 5,0
Artikel-Nr.	7930
925 Silber 1 St.	•
925 Silber 10 St.	•

Schließen mit Hebel-Druck-System, quadratisch, gebogen Clasps with lever-back-system, quadratical, curved		
Außen x Länge in mm ca.	3,3 x 3,3 x 13,7	3,7 x 3,7 x 14,5
Bohrung in mm ca.	Ø 2,0	Ø 2,5
Artikel-Nr.	8920	8925
925 Silber 1 St.	•	•
925 Silber 10 St.	•	•

Schließen mit Hebel-Druck-System, rund, gebogen Clasps with lever-back-system, round, curved					
Außen-Ø x Länge in mm	4,3 x 22,5	5,6 x 23,0	6,5 x 25,1	8,0 x 22,5	8,5 x 22,5
Bohrung-Ø in mm ca.	3,0	3,9	5,0	6,5	7,0
Artikel-Nr.	7830	7840	7850	7865	7870
925 Silber 1 St.	•	•	•	•	•
925 Silber 10 St.	•	•	•	•	•
585 GG 1 St.	•	•	•		
750 GG 1 St.	•	•	•		
750 WG Pd 1 St.	•	•			





Runde Einschnapp- ringe Round Snap-in-rings				
Außen-Ø in mm ca.	15,0	19,0	15,0	22,0
Innen-Ø in mm ca.	8,5	13,5	10,0	16,0
Materialform	abgerundet	abgerundet	flach	abgerundet
Artikel-Nr.	342A	342B	342C	342D
925 Silber 1 St.	•	•	•	•
925 Silber 10 St.	•	•	•	•
585 GG 1 St.	•	•	•	auf Anfrage
585 WG Pd 1 St.	•	•	•	
750 GG 1 St.	•	•	•	auf Anfrage
750 WG Pd 1 St.	•	•	•	





Runde Einschnapp- ringe, rund Round snap-in-rings, round					
Außen-Ø in mm ca.	9,8	11,8	12,5	13,2	14,4
Innen-Ø in mm ca.	6,0	7,8	7,2	8,3	9,6
Materialstärke in mm ca.	1,9	2,0	2,4	2,45	2,5
Artikel-Nr.	342J	342L	342H	342M	342E
925 Silber 1 St.	•	•	•	•	•
925 Silber 10 St.	•	•	•	•	•
585 GG 1 St.	•	•	•	•	•
585 WG Pd 1 St.			•		
750 GG 1 St.	•	•	•	•	•
750 RotG 1 St.			•		
750 WG Pd 1 St.			•		





Runde Einschnapp- ringe, rund Round snap-in-rings, round					
Außen-Ø in mm ca.	16,1	17,6	19,7		
Innen-Ø in mm ca.	10,7	11,7	14,0		
Materialstärke in mm ca.	2,8	3,0	3,0		
Artikel-Nr.	342K	342F	342G		
925 Silber 1 St.	•	•	•		
925 Silber 10 St.	•	•	•		
585 GG 1 St.	•	•			
750 GG 1 St.	•	•			

SUMA FURNITUREN

Mulde 10 D-75239 Eisingen • ☎ +49 (0) 7232 809 454 • 📠 +49 (0) 7232 809 453 • ✉ info@sumafurnituren.de • www.sumafurnituren.de





Runde Einschnapp- ringe, flach Round snap-in-rings, flat					
Außen-Ø in mm ca.	14	15,8	17,9	19,7	
Innen-Ø in mm ca.	9,0	10,0	11,2	13,4	
Artikel-Nr.	342N	342O	342P	342R	
925 Silber 1 St.	•	•	•	•	
925 Silber 10 St.	•	•	•	•	



Ovale Einschnapp- ringe, runde Einschnapp- ringe mit Öse Oval and round Snap- in-rings with ring					
Außen-Ø in mm ca.	19,4 x 14,3	14,2 x 7,3	14,5	17,5	13,5
Innen-Ø in mm ca.	13,8 x 4,0	10,7 x 4,1	10,5	13,8	8,7
Artikel-Nr.	343A	343B	344A	344B	344C
925 Silber 1 St.	•	•	•	•	•
925 Silber 10 St.	•			•	
585 GG 1 St.	•			•	
585 WG Pd 1 St.	•				
750 GG 1 St.	•				



Runde Einschnapp- ringe mit Fädelloch Round Snap-in-rings with hole					
Außen-Ø in mm ca.	11,00	11,5	15,0	15,5	
Innen-Ø in mm ca.	8,0	8,0	10,5	12,5	
Artikel-Nr.	346A	347A	347B	347C	
925 Silber 1 St.	•	•	•	•	
925 Silber 10 St.		•	•	•	
585 GG 1 St.	•	•		•	
750 GG 1 St.	•	•		•	

SUMA FURNITUREN

Mulde 10 D-75239 Eisingen • ☎ +49 (0) 7232 809 454 • 📠 +49 (0) 7232 809 453 • ✉ info@sumafurnituren.de • www.sumafurnituren.de







Einschnappringe mit Öse Snap-in-rings with ring					 (NEU)
Außenmaß / Länge in mm ca.	12,5 x 6,0	18,0	24,0	19,5	14,1 x 5,8
Breite in mm ca.	3,5	3,0	2,5	3,0	1,0
Artikel-Nr.	345A	345B	345C	345D	345K
925 Silber 1 St.	•	•	•	•	•
925 Silber 10 St.	•				
585 GG 1 St.	•	•	•	•	
585 RoseG 1 St.				•	
585 WG Pd 1 St.	•	•		•	
750 GG 1 St.	•	•	•	•	
750 RoseG 1 St.				•	
750 RotG 1 St.	•				
750 WG Pd 1 St.	•	•		•	





Einschnappringe Navetteform Snap-in-rings navette			 (NEU)		
Länge x Breite in mm ca.	15,5	17 x 8	16,6 x 10,4		
Innen-Maß in mm ca.		8,9 x 3,8	7,4		
Artikel-Nr.	345E	345F	345H		
925 Silber 1 St.	•	•	•		
585 GG 1 St.	•	•			
585 WG Pd 1 St.	•	•			
750 GG 1 St.	•	•			
750 WG 1 St.	•	•			

Einschnappringe Herz Snap-in-rings heart shape					
Breite in mm ca.	14	15	18		
Höhe in mm ca.	14	13,1	15,5		
Artikel-Nr.	348/14	348/15	348/18		
925 Silber 1 St.	•	•	•		
925 Silber 10 St.	•	•	•		

SUMA FURNITUREN

Mulde 10 D-75239 Eisingen • ☎ +49 (0) 7232 809 454 • 📠 +49 (0) 7232 809 453 • ✉ info@sumafurnituren.de • www.sumafurnituren.de







S-Haken, Verschluss-Haken mit Öse S-Hook							
Abmessung in mm ca.	15 x 7	19 x 9	20 x 9,6	15 x 7	20 x 9	15 x 7	20 x 9
	glatt	glatt	glatt			mit Queröse	
Artikel-Nr.	290M	290N	290L	291A	291C	291B	291D
935 Silber 1 St.	•	•	•	•	•	•	•
935 Silber 10 St.	•	•	•	•	•	•	•
935 Silber GGP 05 1 St.	•	•	•	•	•	•	•
935 Silber RH 1 St.	•	•	•	•	•	•	•
585 GG 1 St.	•	•		•		•	
590 WG Pd 1 St.	•						
750 GG 1 St.	•			•	•	•	

Kugelschlösser, rund, glatt Ball clasps, round, smooth					
Ø in mm ca.	6,0	8,0	10,0	15,0 x 4,5	15,0 x 4,5
Artikel-Nr.	270/6	270/8	270/10	265 E	266 C
925 Silber VG 1 St.	•	•	•	•	•
925 Silber RH 1 St.	•	•	•	•	•
585 GG 1 St.		•	•		
590 WG RH 1 St.	•	•			
750 GG 1 St.	•	•	•		



Magnetschlösser in hochwertiger Qualität





Stabile Ausführung, Hülse und Öse werden aus einem Teil gefertigt. Durch die etwas längliche Form kann das Schloss in der Mitte geknickt und somit einfach und bequem geöffnet werden.





Magnetschlösser, zylindrisch, mit 2 Ösen Magnetic clasps, cy- lindrical, with 2 rings						
Ø x Länge (ohne Öse) in mm ca.	3,9 x 7,0	5,0 x 7,2	5,9 x 8,0	6,9 x 9,0	7,8 x 10,5	8,8 x 10,7
Artikel-Nr.	263/4	263/5	263/6	263/7	263/8	263/9
925 Silber 1 St.	•	•	•	•	•	•
925 Silber 10 St.	•	•	•	•	•	•
925 Silber VG 1 St.	•	•	•	•	•	•
925 Silber VG 10 St.	•	•	•	•	•	•
925 Silber RH 1 St.	•	•	•	•	•	•
925 Silber RH 10 St.	•	•	•	•	•	•



Magnetschlösser in hochwertiger Qualität









in wasserdichter Edelmetallhülle geschützt vor Schweiß, Feuchtigkeit und Zerstörung durch Schlag









Magnetschlösser, rund, mit 2 Ösen Magnetic clasps, round, with 2 rings					
Ø mm ca.	6,0	8,0	10,0	12,0	14,0
Artikel-Nr.	264/6	264/8	264/10	264/12	264/14
925 Silber 1 St.	•	•	•	•	•
925 Silber VG 1 St.	•	•	•	•	•
925 Silber RotVG 1 St.	•	•	•	•	•
925 Silber RH 1 St.	•	•	•	•	•
925 Silber matt 1 St.	•	•	•	•	•
925 Silber VG matt 1 St.	•	•	•	•	•
925 Silber RotVG matt 1 St.	•	•	•	•	•
925 Silber RH matt 1 St.	•	•	•	•	•
585 GG 1 St.	•	•	•	•	•
585 GG matt 1 St.	•	•	•	•	•
590 WG 1 St.	•	•	•	•	•
590 WG matt 1 St.	•	•	•	•	•
750 GG 1 St.	•	•	•	•	•
750 GG matt 1 St.	•	•	•	•	•

Magnetschlösser Stern-effekt, rund, mit 2 Ösen Magnetic clasps, star dust, round, with 2 rings					
Ø mm ca.	6,0	8,0	10,0	12,0	14,0
Artikel-Nr.	262/6	262/8	262/10	262/12	262/14
925 Silber 1 St.	•	•	•	•	•
925 Silber VG 1 St.	•	•	•	•	•
925 Silber RH 1 St.	•	•	•	•	•

SUMA FURNITUREN

Mulde 10 D-75239 Eisingen • ☎ +49 (0) 7232 809 454 • 📠 +49 (0) 7232 809 453 • ✉ info@sumafurnituren.de • www.sumafurnituren.de









Biegeringe, rund Jump rings, round								
Außen-Ø in mm ca.	3,0	3,0	3,5	4,0	4,0	4,0	4,5	4,5
Draht-Ø in mm ca.	0,6	0,7	0,7	0,7	0,8	1,0	0,7	0,8
Artikel-Nr.	250B	250B2	250C	250D2	250D	250O	250E2	250E
935 Silber 10 St.	•	•	•	•	•	•	•	•
935 Silber 100 St.	•	•	•	•	•	•	•	•
935 Silber 250 St.	•	•	•	•	•	•	•	•
935 Silber 1000 St.	•	•	•	•	•	•	•	•
333 GG 1 St.	•	•	•	•	•			•
333 GG 10 St.	•	•	•	•	•			•
585 GG 1 St.	•	•	•	•	•	•	•	•
585 GG 10 St.	•	•	•	•	•		•	•
585 RotG 1 St.		•	•		•			•
585 RotG 10 St.		•	•		•			•
585 WG Pd 1 St.	•	•	•	•	•		•	•
585 WG Pd 10 St.	•	•	•	•	•		•	•
750 GG 1 St.	•	•	•	•	•	•	•	•
750 GG 10 St.	•	•	•	•	•		•	•
750 RotG 1 St.		•	•	•	•			•
750 RotG 10 St.		•	•	•	•			•
750 WG Pd 1 St.	•	•	•		•	•		
750 WG Pd 10 St.	•	•	•		•			



Biegeringe, rund Jump rings, round								
Außen-Ø in mm ca.	5,0	5,0	5,0	5,0	6,0	6,0	6,0	6,0
Draht-Ø in mm ca.	0,8	0,9	1,0	1,2	0,9	1,0	1,2	1,5
Artikel-Nr.	250F2	250F	250P	250P2	250G2	250G	250R	250R2
935 Silber 10 St.	•	•	•	•	•	•	•	•
935 Silber 100 St.	•	•	•	•	•	•	•	•
935 Silber 250 St.	•	•	•	•	•	•	•	•
935 Silber 1000 St.	•	•	•	•	•	•	•	•
333 GG 1 St.		•				•		
333 GG 10 St.		•				•		
585 GG 1 St.	•	•	•		•	•	•	
585 GG 10 St.	•	•	•		•	•		
585 WG Pd 1 St.	•	•			•	•		
585 WG Pd 10 St.	•	•			•	•		
750 GG 1 St.	•	•		•	•	•	•	
750 GG 10 St.	•	•			•	•		
750 WG Pd 1 St.		•	•			•	•	
750 WG Pd 10 St.		•	•			•		

SUMA FURNITUREN

Mulde 10 D-75239 Eisingen • ☎ +49 (0) 7232 809 454 • 📠 +49 (0) 7232 809 453 • ✉ info@sumafurnituren.de • www.sumafurnituren.de







Biegeringe, rund Jump rings, round								
Außen-Ø in mm ca.	7,0	7,0	7,5	8,0	8,0	9,0	10,0	11,5
Draht-Ø in mm ca.	1,1	1,2	1,2	1,1	1,2	1,2	1,2	1,2
Artikel-Nr.	250H	250S	250U	250K	250T	250L	250M	250N
935 Silber 10 St.	5,40	5,30	6,30	5,90	6,90	8,60	9,10	11,30
935 Silber 100 St.	50,00	49,00	58,00	54,00	63,00	78,00	83,00	103,00
935 Silber 250 St.	117,50	117,50	137,50	130,00	152,50	187,50	200,00	
333 GG 1 St.	10,20			13,80				
585 GG 1 St.	20,80	26,80		26,00				
750 GG 1 St.	29,00	34,70						





Biegeringe, oval Jump rings, oval								
Außen-Ø in mm ca.	3,5	4,0	4,5	5,0	6,0	6,2	7,2	8,0
Draht-Ø in mm ca.	0,7	0,8	0,8	0,9	1,0	1,2	1,1	1,2
Artikel-Nr.	251C	251D	251E	251F	251G	251R	251H	251K
935 Silber 10 St.	•	•	•	•	•	•	•	•
935 Silber 100 St.	•	•	•	•	•	•	•	•
935 Silber 250 St.	•	•	•	•	•	•	•	•
333 GG 1 St.	•	•	•	•	•		•	•
333 GG 10 St.	•	•	•	•	•		•	•
585 GG 1 St.	•	•	•	•	•		•	
585 GG 10 St.	•	•	•	•	•		•	
585 WG Pd RH 1 St.	•	•	•	•	•		•	
585 WG Pd RH 10 St.	•	•	•	•	•		•	
750 GG 1 St.	•	•	•	•	•		•	
750 GG 10 St.	•	•	•	•	•		•	





Biegeringe, oval Jump rings, oval								
Außen-Ø in mm ca.	9,0	10,0						
Draht-Ø in mm ca.	1,3	1,2						
Artikel-Nr.	251L	251M						
935 Silber 10 St.	•	•						
935 Silber 100 St.	•	•						
935 Silber 250 St.	•	•						









SUMA FURNITUREN







Mulde 10 D-75239 Eisingen • ☎ +49 (0) 7232 809 454 • 📠 +49 (0) 7232 809 453 • ✉ info@sumafurnituren.de • www.sumafurnituren.de

Biegeringe, rund starke Ausführung Jump rings, round strong version							
Außen-Ø in mm ca.	10,0	11,0	12,0	14,0	16,0	18,0	20,0
Draht-Ø in mm ca.	1,5	1,5	1,5	1,5	1,5	1,5	1,5
Artikel-Nr.	253/10	253/11	253/12	253/14	253/16	253/18	253/20
935 Silber 1 St.	•	•	•	•	•	•	•
935 Silber 10 St.	•	•	•	•	•	•	•

Biegeringe, rund starke Ausführung Jump rings, round strong version						
Außen-Ø in mm ca.	13,5	14,5	16,5	18,5	20,5	
Draht-Ø in mm ca.	1,8	1,8	1,8	1,8	1,8	
Artikel-Nr.	254/13	254/14	254/16	254/18	254/20	
935 Silber 1 St.	•	•	•	•	•	
935 Silber 10 St.	•	•	•	•	•	

Biegeringe, rund starke Ausführung Jump rings, round strong version						
Außen-Ø in mm ca.	14,0	16,0	18,0	20,0	22,0	
Draht-Ø in mm ca.	2,0	2,0	2,0	2,0	2,0	
Artikel-Nr.	256/14	256/16	256/18	256/20	256/22	
935 Silber 1 St.	•	•	•	•	•	
935 Silber 10 St.	•	•	•	•	•	

Biegeringe, rund fugenlos gelötet Jump rings, round closed by soldering								
Außen-Ø in mm ca.	4,5	5,0	6,0	7,0	8,0	9,0	10,0	11,5
Draht-Ø in mm ca.	0,8	0,9	1,0	1,1	1,1	1,2	1,2	1,2
Artikel-Nr.	252E	252F	252G	252H	252K	252L	252M	252N
935 Silber 1 St.	•	•	•	•	•	•	•	•
935 Silber 10 St.	•	•	•	•	•	•	•	•
935 Silber 100 St.	•	•	•	•	•	•	•	•
585 GG 1 St.	•	•	•					
585 WG Pd 1 St.	•	•						
750 GG 1 St.	•	•	•					

Biegeringe, oval fugenlos gelötet Jump rings, oval closed by soldering								
Außen-Ø in mm ca.	4,5	4,8	6,0	7,2	8,2	9,4	10,0	
Draht-Ø in mm ca.	0,8	0,9	1,0	1,1	1,1	1,2	1,2	
Artikel-Nr.	241E	241F	241G	241H	241K	241L	241M	
935 Silber 1 St.	•	•	•	•	•	•	•	
935 Silber 10 St.	•	•	•	•	•	•	•	
935 Silber 100 St.	•	•	•	•	•	•	•	
585 GG 1 St.	•	•	•					







Biegeringsortimente
mit runden oder ovalen Ösen
sortiert in transparenter Dose mit 10 Fächern





Assortment of jump rings
with round and oval jump rings
in transparent cases

Ösensortimente Assortment of jump rings		
	rund, 3,0 - 7,0 mm, Inhalt 150 Stück	oval, 3,5 - 7,0 mm, Inhalt 150 Stück
Artikel-Nr.	255	257
935 Silber 1 St.	•	•

SUMA FURNITUREN

Mulde 10 D-75239 Eisingen • ☎ +49 (0) 7232 809 454 • 📠 +49 (0) 7232 809 453 • ✉ info@sumafurnituren.de • www.sumafurnituren.de

Stempelanker, Doppelösen Quality tags, Bead-Attach Rings						
Außenmaß in mm ca.	4,2 x 3,3	4,4 x 3,1	6,5 x 4,5	5,0 x 3,0	6,5 x 4,5	8 x 5
Materialstärke in mm ca.	0,5	0,3	0,7	0,6	0,5	0,5
	mit Feingehaltstempel				ohne Feingehaltstempel	
Artikel-Nr.	260	260	260G	260P	2762/6/0,5	2762/8/0,5
925 Silber 1 St.	•		•	•	•	•
925 Silber 10 St.	•		•	•	•	•
925 Silber 100 St.	•		•	•	•	•
333 GG 1 St.		•				
585 GG 1 St.		•		•	•	•
585 WG Pd 1 St.		•				
750 GG 1 St.		•		•		
750 RotG 1 St.		•				
750 WG Pd 1 St.		•				

Doppelösen Bead-Attach Rings						
Außen-Ø in mm ca.	3,5 / 5,0	5,0 / 7,0	6,0 / 9,0	3,5 / 5,0		
Materialstärke in mm ca.	Silber: 0,8 Gold: 0,7	Silber: 1,0 Gold: 0,9	Silber: 1,2	Silber: 0,8 Gold: 0,7		
Artikel-Nr.	261A	261G	261L	261B		
925 Silber 1 St.	•	•	•	•		
925 Silber 10 St.	•	•	•	•		
925 Silber 100 St.	•	•	•	•		
333 GG 1 St.	•	•		•		
585 GG 1 St.	•	•		•		
750 GG 1 St.	•	•		•		







Spaltringe, rund



schwere Ausführung
stabile und solide Qualität
Draht in „Messerdrahtform“ mit Diamantschnitt



251 V

Spaltringe, rund Split rings, round					
Außen-Ø in mm ca.	5,2	6,2	7,3	8,3	9,3
Innen-Ø in mm ca.	3,5	4,3	5,0	6,0	7,0
Breite in mm ca.	1,1	1,3	1,5	1,7	1,8
Artikel-Nr.	251U	251V	251W	251X	251Y
935 Silber 10 St.	•	•	•	•	•
935 Silber 100 St.	•	•	•	•	•

Anhängerschlaufen zum Einhängen Pendant loop						
Höhe x Breite (vorne) in mm ca.	10,0 x 2,5	11,5 x 3,0 mit Feder	13,1 x 2,2	11,0 x 2,5	10,0 x 2,0	7,9 x 2,4
Artikel-Nr.	275H	274A	274B	274D	274H	274E
925 Silber 1 St.	•	•	•	•	•	•
925 Silber 10 St.	•	•	•	•	•	•
585 GG 1 St.	•	•	•	•	•	•
585 RotG 1 St.	•		•	•	•	
590 WG 1 St.	•		•	•	•	
590 WG RH 1 St.	•		•	•	•	
750 GG 1 St.	•	•	•	•	•	•
750 RoseG 1 St.	•		•	•	•	
750 RotG 1 St.	•		•	•	•	
750 WG 1 St.	•		•	•	•	
750 WG RH 1 St.	•		•	•	•	
950 Platin 1 St.	•		•	•	•	

Anhängerschlaufen zum Einhängen, Greif- schlaufe, erttenclipme- chanik zum Verkürzen von Perl- oder Stein- ketten Pendant loops						
	Schlaufe glatt					
Länge x Breite in mm ca.	22,5	12,0 x 5,0	16,1 x 8,2			
Materialstärke in mm ca.	0,5	0,5				
Artikel-Nr.	120A	120C	275K			
935 Silber 1 St.	•	•	•			
935 Silber 10 St.	•	•	•			
585 GG 1 St.	•	•	•			



Passende Perlschalenanhänger finden Sie ab Seite 75.



SUMA FURNITUREN

Mulde 10 D-75239 Eisingen • ☎ +49 (0) 7232 809 454 • 📠 +49 (0) 7232 809 453 • ✉ info@sumafurnituren.de • www.sumafurnituren.de



Anhängerschlaufen zum Einhängen, Anlötschlaufen Pendant loops, pendant loops for soldering						
	glatt	glatt	glatt	glatt		
Länge x Breite in mm ca.	7,0 x 2,0	8,5 x 3,0	10,3 x 3,6	7,7 x 2,3		
Materialstärke in mm ca.	0,35	0,40	0,50	0,40		
Artikel-Nr.	120E	120G	120/8	120/20		
935 Silber 1 St.	•	•	•	•		
935 Silber 10 St.	•	•	•	•		
935 Silber 100 St.	•	•	•	•		
333 GG 1 St.	•	•				
333 GG 10 St.	•	•				
585 GG 1 St.	•	•	•	•		
585 GG 10 St.	•	•				
585 WG Pd 1 St.	•	•				
750 GG 1 St.	•	•				
750 WG Pd 1 St.	•					

Anhängerschlaufen zum Einhängen, Anlötschlaufen Pendant loops, pendant loops for soldering						
	glatt, Guss	glatt, Guss				
Länge x Breite in mm ca.	6,7 x 3,2	8,7 x 4,0				
Artikel-Nr.	120T	120R				
935 Silber 1 St.	•	•				
935 Silber 10 St.	•	•				
333 GG 1 St.	•	•				
585 GG 1 St.	•	•				
585 WG Pd 1 St.	•	•				
750 GG 1 St.	•	•				
750 WG Pd 1 St.	•	•				



Anlötschlaufen Pendant loops for soldering						
	glatt	glatt	glatt	gerieft		
Länge x Breite in mm ca.	7,0 x 4,0	10,0 x 4,0	9,3 x 6,0	8,6 x 3,6		
Materialstärke in mm ca.	0,40	0,60	0,50	0,90		
Artikel-Nr.	120KG	120LG	120/5	120/6		
935 Silber 1 St.	•	•	•	•		
935 Silber 10 St.	•	•	•	•		
935 Silber 100 St.	•	•	•	•		
333 GG 1 St.	•		•			
585 GG 1 St.	•	•	•	•		
585 WG Pd 1 St.	•		•			
750 GG 1 St.	•		•	•		
750 WG Pd 1 St.	•					

Anlötschlaufen Pendant loops for soldering						
	glatt	glatt	glatt	glatt		
Länge x Breite in mm ca.	7 x 2	6,4 x 2,5	8,2 x 2,5	11,6 x 3,4		
Materialstärke in mm ca.	0,50	0,50	0,60	0,80		
Artikel-Nr.	120/7	120/10	120/12	120/13		
935 Silber 1 St.	•	•	•	•		
935 Silber 10 St.	•	•	•	•		
935 Silber 100 St.	•	•	•			
333 GG 1 St.	•	•	•	•		
585 GG 1 St.	•	•	•	•		
585 WG Pd 1 St.	•	•	•	•		
750 GG 1 St.	•	•	•	•		
750 WG Pd 1 St.		•	•	•		

SUMA FURNITUREN

Mulde 10 D-75239 Eisingen • ☎ +49 (0) 7232 809 454 • 📠 +49 (0) 7232 809 453 • ✉ info@sumafurnituren.de • www.sumafurnituren.de

Kopfstifte

in verschiedenen Durchmessern und Längen erhältlich.

Headpins

in different diameters and lengths available.

Draht-Ø ca. 0,5 mm wire-Ø ca. 0,5 mm						
Kopf-Ø in mm ca.		2,5	2,5	3,2	3,2	
Länge in mm ca.		50	70	50	70	
Artikel-Nr.		4025/50	4025/70	4035/50	4035/70	
935 Silber	1 St.	•	•	•	•	
935 Silber	10 St.	•	•	•	•	





Draht-Ø ca. 0,6 mm wire-Ø ca. 0,6 mm						
Kopf-Ø in mm ca.		2,5	2,5	3,2	3,2	
Länge in mm ca.		50	70	50	70	
Artikel-Nr.		4026/50	4026/70	4036/50	4036/70	
935 Silber	1 St.	•	•	•	•	
935 Silber	10 St.	•	•	•	•	







Draht-Ø ca. 0,7 mm wire-Ø ca. 0,7 mm						
Kopf-Ø in mm ca.		2,5	2,5	3,2	3,2	
Länge in mm ca.		50	70	50	70	
Artikel-Nr.		4027/50	4027/70	4037/50	4037/70	
935 Silber	1 St.	•	•	•	•	
935 Silber	10 St.	•	•	•	•	





Draht-Ø ca. 0,8 mm wire-Ø ca. 0,8 mm						
Kopf-Ø in mm ca.		2,5	2,5	3,2	3,2	
Länge in mm ca.		50	70	50	70	
Artikel-Nr.		4028/50	4028/70	4038/50	4038/70	
935 Silber	1 St.	•	•	•	•	
935 Silber	10 St.	•	•	•	•	

Draht-Ø ca. 0,9 mm wire-Ø ca. 0,9 mm						
Kopf-Ø in mm ca.		2,5	2,5	3,2	3,2	
Länge in mm ca.		50	70	50	70	
Artikel-Nr.		4029/50	4029/70	4039/50	4039/70	
935 Silber	1 St.	•	•	•	•	
935 Silber	10 St.	•	•	•	•	

Kopfstifte mit Kugel Ballpins						
Ø in mm ca.		2,0	2,0	2,0	2,0	
Länge in mm ca.		50	75	50	75	
Draht-Ø in mm ca.		0,5	0,5	0,65	0,65	
Artikel-Nr.		3925/50	3925/75	3926/50	3926/75	
925 Silber	1 St.	•	•	•	•	
925 Silber	10 St.	•	•	•	•	
925 Silber	100 St.	•	•	•	•	





Stiftösen Eyepins						
Ösen-Ø / Draht-Ø mm ca.	3,0 / 0,8	3,5 / 0,8	3,2 / 0,7	3,2 / 0,7	4,5 / 0,75	
Länge in mm ca.	20,0	20,0	10,2	6,7	11	
Artikel-Nr.	275B	275C	275U	275V	275X	
935 Silber 1 St.	•	•	•	•	•	
935 Silber 10 St.	•	•	•	•	•	
935 Silber 100 St.	•	•	•	•	•	
Double 1 St.	•	•				
Double 10 St.	•	•				
Double 100 St.	•	•				





Perlschalenanhänger mit Öse und kurzer Stift Pendant for pearls with ring and short pin						
Länge in mm ca.	5,0	5,0	5,0	10,0	10,0	10,0
Perlschalen-Ø in mm ca.	3,0	4,0	5,0	3,0	4,0	5,0
	kurzer Stift / short pin			langer Stift / long pin		
Artikel-Nr.	121A/3	121A/4	121A/5	121B/3	121B/4	121B/5
935 Silber 1 St.	•	•	•	•	•	•
935 Silber 10 St.	•	•	•	•	•	•
935 Silber 100 St.	•	•	•	•	•	•







Perlschalenanhänger mit Öse und Stift, leichte Ausführung Pendant loops for pearls, light version						
Ø in mm ca.	6,0	7,5	8,0	11,5		
Artikel-Nr.	321B/6	321B/7	321B/8	321B/12		
925 Silber 1 St.	•	•	•	•		
925 Silber 10 St.	•	•	•	•		
925 Silber 100 St.	•	•	•	•		





SUMA FURNITUREN





Mulde 10 D-75239 Eisingen • ☎ +49 (0) 7232 809 454 • 📠 +49 (0) 7232 809 453 • ✉ info@sumafurnituren.de • www.sumafurnituren.de

Perlschalenanhänger (Guss) mit Öse Pendant loops for pearls with ring				
Gesamtlänge in mm ca.	8,9	8,9	8,9	8,9
Stiftlänge / Stift-Ø mm ca.	5,3 / 0,9	5,3 / 0,9	5,3 / 0,9	5,3 / 0,9
Perlschalen-Ø in mm ca.	3	4	5	6
Ösen-Ø Außen x Draht- stärke mm ca.	3,3 x 0,8	3,3 x 0,8	3,3 x 0,8	3,3 x 0,8
Ösen-Ø Innen mm ca.	1,7	1,7	1,7	1,7
Artikel-Nr.	273F/3	273F/4	273F/5	273F/6
935 Silber 1 St.	•	•	•	•
935 Silber 10 St.	•	•	•	•
585 GG 1 St.	•	•	•	•
585 RotG 1 St.	•	•	•	•
585 WG Pd 1 St.	•	•	•	•
750 GG 1 St.	•	•	•	•
750 RoseG 1 St.	•	•	•	•
750 RotG 1 St.	•	•	•	•
750 WG Pd 1 St.	•	•	•	•
950 Platin 1 St.	•	•	•	•

Perlschalenanhänger (Guss) mit Öse Pendant loops for pearls with ring				
Gesamtlänge in mm ca.	12	11,7	11,5	11,5
Stiftlänge / Stift-Ø mm ca.	5,3 / 0,9	5,3 / 0,9	5,3 / 0,9	5,3 / 0,9
Perlschalen-Ø in mm ca.	4	4	4	4
Schlaufe / Öse Außen mm ca.	6,3 x 1,2	4,8 x 0,8	2,3 breit 5,6 lang Schlaufe gerade	3,6 breit (oben) 5,6 lang Schlaufe konisch
Schlaufe / Öse Innen mm ca.	3,9	2,9 breit 3,8 lang	2,5 breit 3,6 lang	2,5 breit 3,6 lang
Artikel-Nr.	273TA/4	273TC/4	273A/4	273B/4
935 Silber 1 St.	•	•	•	•
935 Silber 10 St.	•	•	•	•
585 GG 1 St.	•	•	•	•
585 RotG 1 St.	•	•	•	•
585 WG Pd 1 St.	•	•	•	•
750 GG 1 St.	•	•	•	•
750 RoseG 1 St.	•	•	•	•
750 RotG 1 St.	•	•	•	•
750 WG Pd 1 St.	•	•	•	•
950 Platin 1 St.	•	•	•	•

Perlschalenanhänger mit Öse Pendant loops for pearls with ring						
Gesamtlänge in mm ca.	11	12	10,7	11,5	12,7	14
Stiftlänge / Stift-Ø mm ca.	5	5	5	5	5	5
Perlkappen-Ø in mm ca.	3	4	3	4	5	6
Öse Außen/Innen mm ca.	4 / 2,4	4 / 2,4	4 / 2,4	4 / 2,4	4 / 2,4	4 / 2,4
Artikel-Nr.	131A/3	131A/4	131B/3	131B/4	131B/5	131B/6
935 Silber 1 St.	•	•	•	•	•	•
935 Silber 10 St.	•	•	•	•	•	•
585 GG 1 St.	•	•	•	•	•	•
585 WG Pd 1 St.	•	•	•	•	•	•
750 GG 1 St.	•	•	•	•	•	•
750 WG Pd 1 St.	•	•	•	•	•	•

Perlschalenanhänger mit Öse Pendant loops for pearls with ring						
Gesamtlänge in mm ca.	10	11	12	12,8		
Stiftlänge / Stift-Ø mm ca.	5	5	5	5		
Perlkappen-Ø in mm ca.	3	4	5	6		
Öse Außen/Innen mm ca.	4 / 2,4	4 / 2,4	4 / 2,4	4 / 2,4		
Artikel-Nr.	131C/3	131C/4	131C/5	131C/6		
935 Silber 1 St.	•	•	•	•		
935 Silber 10 St.	•	•	•	•		
585 GG 1 St.	•	•	•	•		
585 WG Pd 1 St.	•	•	•	•		
750 GG 1 St.	•	•	•	•		
750 WG Pd 1 St.	•	•	•	•		

Perlschalenanhänger mit Doppelschlaufe Pendant loops for pearls				
Gesamtlänge in mm ca.	9,3	10,7	10,7	10,7
Stiftlänge / Stift-Ø mm ca.	4,3 / 0,9	5,3 / 0,9	5,3 / 0,9	5,3 / 0,9
Perlschalen-Ø in mm ca.	-	4	5	6
Artikel-Nr.	275S	275P/4	275P/5	275P/6
935 Silber 1 St.	•	•	•	•
935 Silber 10 St.	•	•	•	•
585 GG 1 St.	•	•	•	•
585 RotG 1 St.	•	•	•	•
585 WG Pd 1 St.	•	•	•	•
750 GG 1 St.	•	•	•	•
750 RoseG 1 St.	•	•	•	•
750 RotG 1 St.	•	•	•	•
750 WG Pd 1 St.	•	•	•	•
950 Platin 1 St.	•	•	•	•

SUMA FURNITUREN

Mulde 10 D-75239 Eisingen • ☎ +49 (0) 7232 809 454 • 📠 +49 (0) 7232 809 453 • ✉ info@sumafurnituren.de • www.sumafurnituren.de



276A



276G



276N



276R

Anhängerplättchen / Identitätsplättchen mit Öse / mit Bohrung ID-Tags with ring								
Abmessungen in mm ca.	9 x 5,5	8 x 8	Ø 8	Ø 10	9 x 5,5	8 x 8	13 x 7	16 x 8
Materialstärke in mm ca.	0,30	0,30	0,50	0,50	0,60	0,60	0,60	0,60
Artikel-Nr.	276A	276B	276C	276D	276E	276F	276G	276H
935 Silber 1 St.	•	•	•	•	•	•	•	•
935 Silber 10 St.	•	•	•	•	•	•	•	•
935 Silber 100 St.	•	•	•	•	•	•	•	•
585 GG 1 St.	•		•	•	•		•	
750 GG 1 St.	•							

Anhängerplättchen mit Öse und Schlaufe Tags with ring and loop								
Abmessungen in mm ca.	9,0 x 5,5	8,0 x 8,0	8,0	10,0	10,0			
mit Anhängerschlaufe Nr.	120 E	120 E	120 E	120 E	120 G			
Artikel-Nr.	276M	276N	276O	276P	276R			
935 Silber 1 St.	•	•	•	•	•			
935 Silber 10 St.	•	•	•	•	•			
935 Silber 100 St.	•	•	•	•	•			
585 GG 1 St.			•	•				

NEU

Anhängerplättchen / Logoplättchen / ID-Tags OVAL

Blechstärke 0,50 mm



276/8/0,5

Anhängerplättchen mit Bohrung, oval ID-Tags with hole, oval						
Abmessungen in mm ca.	6,5 x 4,5	8,1 x 5	13,5 x 10	6,5 x 4,5	8,1 x 5	13,5 x 10
Materialstärke in mm ca.	0,5	0,5	0,5	0,5	0,5	0,5
Artikel-Nr.	276/6/0,5	276/8/0,5	276/13/0,5	2762/6/0,5	2762/8/0,5	2762/13/0,5
935 Silber 1 St.	•	•	•	•	•	•
935 Silber 10 St.	•	•	•	•	•	•
935 Silber 100 St.	•	•	•	•	•	•
585 GG 1 St.	•	•	•	•	•	•

Anhängerplättchen / Logoplättchen / ID-Tags OVAL

Blechstärke 1,0 mm

Anhängerplättchen mit Bohrung, oval ID-Tags with hole, oval						
Abmessungen in mm ca.	6,5 x 4,5	8,1 x 5	13,5 x 10	6,5 x 4,5	8,1 x 5	13,5 x 10
Materialstärke in mm ca.	1,0	1,0	1,0	1,0	1,0	1,0
Artikel-Nr.	276/6/1,0	276/8/1,0	276/13/1,0	2762/6/1,0	2762/8/1,0	2762/13/1,0
935 Silber 1 St.	•	•	•	•	•	•
935 Silber 10 St.	•	•	•	•	•	•
935 Silber 100 St.	•	•	•	•	•	•
585 GG 1 St.	•	•	•	•	•	•

SUMA FURNITUREN

Mulde 10 D-75239 Eisingen • ☎ +49 (0) 7232 809 454 • 📠 +49 (0) 7232 809 453 • ✉ info@sumafurnituren.de • www.sumafurnituren.de

NEU

Anhängerplättchen / Logoplättchen / ID-Tags RUND

Blechstärke 0,50 mm



275/10/0,5

Anhängerplättchen mit einer Bohrung, rund ID-Tags with one hole, round							
Abmessungen in mm ca.	5	6	7	8	10	12	15
Materialstärke in mm ca.	0,5	0,5	0,5	0,5	0,5	0,5	0,5
Artikel-Nr.	275/5/0,5	275/6/0,5	275/7/0,5	275/8/0,5	275/10/0,5	275/12/0,5	275/15/0,5
935 Silber 1 St.	•	•	•	•	•	•	•
935 Silber 10 St.	•	•	•	•	•	•	•
935 Silber 100 St.	•	•	•	•	•	•	•
585 GG 1 St.	•	•	•	•	•	•	•
750 GG 1 St.	•	•	•	•	•		

Anhängerplättchen mit einer Bohrung, rund ID-Tags with one hole, round							
Abmessungen in mm ca.	5	6	7	8	10	12	15
Materialstärke in mm ca.	1,0	1,0	1,0	1,0	1,0	1,0	1,0
Artikel-Nr.	275/5/1,0	275/6/1,0	275/7/1,0	275/8/1,0	275/10/1,0	275/12/1,0	275/15/1,0
935 Silber 1 St.	•	•	•	•	•	•	•
935 Silber 10 St.	•	•	•	•	•	•	•
935 Silber 100 St.	•	•	•	•	•		
585 GG 1 St.	•	•	•	•	•		

Anhängerplättchen / Identitätsplättchen mit Öse / mit Bohrung ID-Tags with ring							
Abmessungen in mm ca.	Ø 8	Ø 10					
Materialstärke in mm ca.	0,50	0,50					
Artikel-Nr.	276C	276D					
935 Silber 1 St.	•	•					
935 Silber 10 St.	•	•					
935 Silber 100 St.	•	•					
585 GG 1 St.	•						

NEU

Anhängerplättchen / Logoplättchen / ID-Tags RUND

Blechstärke 1,0 mm



275/10/1,0

Anhängerplättchen mit zwei Bohrungen, rund ID-Tags with two holes, round				
Abmessungen in mm ca.	8	10	12	15
Materialstärke in mm ca.	0,5	0,5	0,5	0,5
Artikel-Nr.	2752/8/0,5	2752/10/0,5	2752/12/0,5	2752/15/0,5
935 Silber 1 St.	•	•	•	•
935 Silber 10 St.	•	•	•	•
935 Silber 100 St.	•	•	•	•
585 GG 1 St.	•	•	•	•

Anhängerplättchen mit zwei Bohrungen, rund ID-Tags with two holes, round				
Abmessungen in mm ca.	8	10	12	15
Materialstärke in mm ca.	1,0	1,0	1,0	1,0
Artikel-Nr.	2752/8/1,0	2752/10/1,0	2752/12/1,0	2752/15/1,0
935 Silber 1 St.	•	•	•	•
935 Silber 10 St.	•	•	•	•
935 Silber 100 St.	•	•		
585 GG 1 St.	•	•		

SUMA FURNITUREN



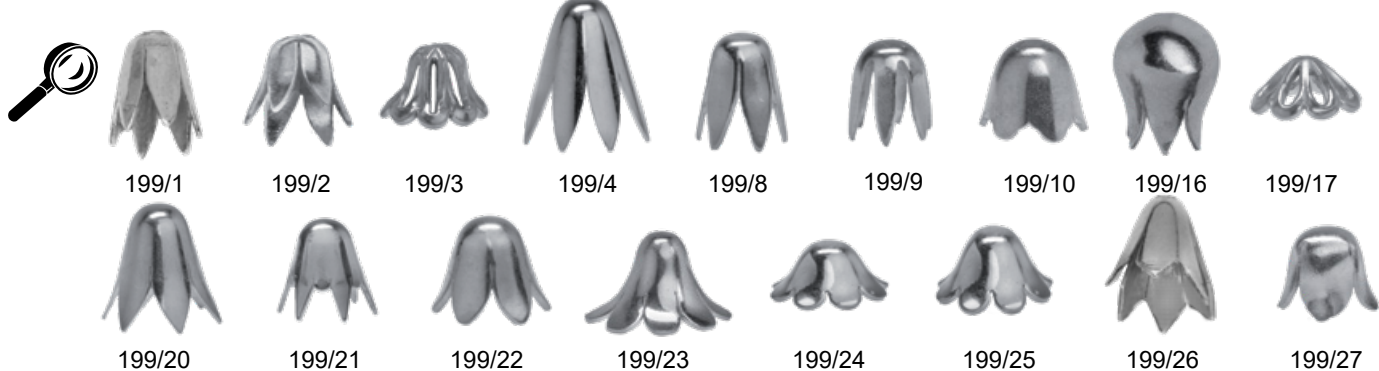



Mulde 10 D-75239 Eisingen • ☎ +49 (0) 7232 809 454 • 📠 +49 (0) 7232 809 453 • ✉ info@sumafurnituren.de • www.sumafurnituren.de













Tulpen mit und ohne Bohrung							
Außen-Ø x Höhe mm ca.	4,0 x 5,6	5,0 x 5,0	5,5 x 4,3	14,8 x 16	4,2 x 5,2	2,9 x 4,4	6,4 x 5,3
Artikel-Nr. ohne Bohrung	199/1	199/2	199/3	199/4	199/8	199/9	199/10
Artikel-Nr. mit Bohrung	198/1	198/2	198/3	198/4	198/8	198/9	198/10
935 Silber 1 St.	•	•	•	•	•	•	•
935 Silber 10 St.	•	•	•	•	•	•	•
585 GG 1 St.	•	•	•	•	•	•	•
750 GG 1 St.	•	•	•	•	•	•	•

Tulpen mit und ohne Bohrung							
Außen-Ø x Höhe mm ca.	7,0 x 8,4	6,8 x 3,1	9,8 x 9,5	8,0 x 7,5	5,6 x 4,6	10,4 x 6,6	8,2 x 3,6
Artikel-Nr. ohne Bohrung	199/16	199/17	199/20	199/21	199/22	199/23	199/24
Artikel-Nr. mit Bohrung	198/16	198/17	198/20	198/21	198/22	198/23	198/24
935 Silber 1 St.	•	•	•	•	•	•	•
935 Silber 10 St.	•	•	•	•	•	•	•
585 GG 1 St.	•	•	•	•	•	•	•
750 GG 1 St.	•	•	•	•	•	•	•

Tulpen mit und ohne Bohrung							
Außen-Ø x Höhe mm ca.	3,3 x 2,0	9,3 x 10,8	5,2 x 4,6				
Artikel-Nr. ohne Bohrung	199/25	199/26	199/27				
Artikel-Nr. mit Bohrung	198/25	198/26	198/27				
935 Silber 1 St.	•	•	•				
935 Silber 10 St.	•	•	•				
585 GG 1 St.	•	•	•				
750 GG 1 St.	•	•	•				

Tulpen mit Öse, mit und ohne Stift							
Außen-Ø x Höhe mm ca.	4,0 x 5,6	5,0 x 5,0	5,5 x 4,3	14,8 x 16	4,2 x 5,2	2,9 x 4,4	6,4 x 5,3
Artikel-Nr. ohne Stift	195/1	195/2	195/3	195/4	195/8	195/9	195/10
Artikel-Nr. mit Stift	197/1	197/2	197/3	197/4	197/8	197/9	197/10
935 Silber 1 St.	•	•	•	•	•	•	•
935 Silber 10 St.	•	•	•	•	•	•	•
585 GG 1 St.	•	•			•	•	•
750 GG 1 St.	•	•			•	•	•

Tulpen mit Öse, mit und ohne Stift							
Außen-Ø x Höhe mm ca.	7,0 x 8,4	6,8 x 3,1	9,8 x 9,5	8,0 x 7,5	5,6 x 4,6	10,4 x 6,6	8,2 x 3,6
Artikel-Nr. ohne Stift	195/16	195/17	195/20	195/21	195/22	195/23	195/24
Artikel-Nr. mit Stift	197/16	197/17	197/20	197/21	197/22	197/23	197/24
935 Silber 1 St.	•	•	•	•	•	•	•
935 Silber 10 St.	•	•	•	•	•	•	•
585 GG 1 St.			•	•	•	•	•
750 GG 1 St.			•	•	•	•	•

Tulpen mit Öse, mit und ohne Stift							
Außen-Ø x Höhe mm ca.	3,3 x 2,0	9,3 x 10,8	5,2 x 4,6				
Artikel-Nr. ohne Stift	195/25	195/26	195/27				
Artikel-Nr. mit Stift	197/25	197/26	197/27				
935 Silber 1 St.	•	•	•				
935 Silber 10 St.	•	•	•				
585 GG 1 St.	•	•	•				
750 GG 1 St.	•		•				



Tulpenanhänger mit Schlaufe

Passende Anhängerschlaufen finden Sie „Anhängerschlaufen für Tulpen“ auf Seite 72



120E

SUMA FURNITUREN

Mulde 10 D-75239 Eisingen • ☎ +49 (0) 7232 809 454 • 📠 +49 (0) 7232 809 453 • ✉ info@sumafurnituren.de • www.sumafurnituren.de



Neue Modelle und stabilere Ausführung

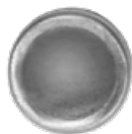

ohne Quersteg
without bar
z.B. Nr. 400/6











mit Quersteg und Fädelloch
with bar and hole
z.B. Nr. 410/6







Gegossene Endkappen, rund, gerieft End caps, casted version, round, corrugated						
Innen-Ø Kapsel mm ca.	4,0	6,0	7,5	4,0	6,0	7,5
Außen-Ø Kapsel mm ca.	6,0	8,0	10,0	6,0	8,0	10,0
Ösen-Innen-Ø in mm ca.	4,5	4,5	4,5	4,5	4,5	4,5
				mit Quersteg / with bar		
Artikel-Nr.	400/4	400/6	400/7,5	410/4	410/6	410/7,5
935 Silber 1 St.	•	•	•	•	•	•
935 Silber 10 St.	•	•	•	•	•	•
585 GG 1 St.	•	•	•	•	•	•
750 GG 1 St.	•	•				

Gegossene Endkappen, rund, glatt End caps, casted version, round, smooth						
Innen-Ø Kapsel mm ca.	4,0	6,0	7,5	4,0	6,0	7,5
Außen-Ø Kapsel mm ca.	6,0	8,0	10,0	6,0	8,0	10,0
Ösen-Innen-Ø in mm ca.	4,5	4,5	4,5	4,5	4,5	4,5
				mit Quersteg / with bar		
Artikel-Nr.	403/4	403/6	403/7,5	413/4	413/6	413/7,5
935 Silber 1 St.	•	•	•	•	•	•
935 Silber 10 St.	•	•	•	•	•	•
585 GG 1 St.	•	•	•	•	•	•
750 GG 1 St.	•	•				

Gegossene Endkappen, rund End caps, round, casted version						
Innen-Ø Kapsel mm ca.	5,0	5,0	5,0	5,0		
Außen-Ø Kapsel mm ca.	6,5	6,5	6,5	6,5		
Ösen-Innen-Ø in mm ca.	4,0	4,5	4,0	4,5		
				mit Quersteg / with bar		
Artikel-Nr.	401/5	401/5G	411/5	411/5G		
935 Silber 1 St.	•	•	•	•		
935 Silber 10 St.	•	•	•	•		
585 GG 1 St.	•	•	•	•		
750 GG 1 St.	•	•	•	•		

Gegossene Endkappen, flach, glatt End caps, flat, smooth, casted version						
Innen-Ø Kapsel mm ca.	5,4 x 2,6	5,4 x 2,6				
Außen-Ø Kapsel mm ca.	6,7 x 3,6	6,7 x 3,6				
Ösen-Innen-Ø in mm ca.	4,2 x 2,0	4,2 x 2,0				
		mit Quersteg / with bar				
Artikel-Nr.	405/5	415/5				
935 Silber 1 St.	•	•				
935 Silber 10 St.	•	•				
585 GG 1 St.	•	•				
750 GG 1 St.	•	•				

Gegossene Endkappen, flach, gerieft End caps, flat, corrugated, casted version						
Innen-Ø Kapsel mm ca.	5,9 x 3,3	8,0 x 3,0	9,5 x 3,0	5,9 x 3,3	8,0 x 3,0	9,5 x 3,0
Außen-Ø Kapsel mm ca.	7,2 x 4,6	9,6 x 4,6	11,1 x 4,7	7,2 x 4,6	9,6 x 4,6	11,1 x 4,7
Ösen-Innen-Ø in mm ca.	4,5	4,5	4,5	4,5	4,5	4,5
				mit Quersteg / with bar		
Artikel-Nr.	402/6	402/8	402/9	412/6	412/8	412/9
935 Silber 1 St.	•	•	•	•	•	•
935 Silber 10 St.	•	•	•	•	•	•
585 GG 1 St.	•	•	•	•	•	•
750 GG 1 St.	•			•		

Gegossene Endkappen, flach, glatt End caps, flat, smooth, casted version						
Innen-Ø Kapsel mm ca.	5,9 x 3,3	8,0 x 3,0	9,5 x 3,0	5,9 x 3,3	8,0 x 3,0	9,5 x 3,0
Außen-Ø Kapsel mm ca.	7,2 x 4,6	9,6 x 4,6	11,1 x 4,7	7,2 x 4,6	9,6 x 4,6	11,1 x 4,7
Ösen-Innen-Ø in mm ca.	4,5	4,5	4,5	4,5	4,5	4,5
				mit Quersteg / with bar		
Artikel-Nr.	404/6	404/8	404/9	414/6	414/8	414/9
935 Silber 1 St.	•	•	•	•	•	•
935 Silber 10 St.	•	•	•	•	•	•
585 GG 1 St.	•	•	•			



Alle Gusskapseln sind auch in Silber vergoldet, Silber goldplattiert und Silber rhodiniert lieferbar; in Weißgold auf Anfrage.

Kugelkapseln Artikel-Nr. 277... mit Standard-Öse 0,70 mm stark



kleine, offene Öse



große, geschlossene Öse

Kugelkapseln Ball caps										
Kapsel-Ø in mm	2,5	3,0	3,5	4,0	5,0	2,5	3,0	3,5	4,0	5,0
Ösenabmessung in mm	3,2 x 0,70					Silber: 4,5 x 0,70 / Gold: 4,2 x 0,70				
	kleine, offene Öse small, open ring					große, geschlossene Öse big, closed ring				
Artikel-Nr.	277S	277A	277B	277C	277D	277T	277E	277F	277G	277H
935 Silber 1 St.	•	•	•	•	•	•	•	•	•	•
935 Silber 10 St.	•	•	•	•	•	•	•	•	•	•
935 Silber 100 St.	•	•	•	•	•	•	•	•	•	•
333 GG 1 St.		•	•	•	•		•	•	•	•
333 GG 10 St.		•	•	•	•		•	•	•	•
585 GG 1 St.	•	•	•	•	•	•	•	•	•	•
585 GG 10 St.	•	•	•	•	•	•	•	•	•	•
585 WG Pd RH 1 St.	•	•	•	•	•	•	•	•	•	•
585 WG Pd RH 10 St.	•	•	•	•	•	•	•	•	•	•
750 GG 1 St.	•	•	•	•	•	•	•	•	•	•
750 GG 10 St.	•	•	•	•	•	•	•	•	•	•
750 WG RH 1 St.		•	•	•	•		•	•	•	
750 WG RH 10 St.		•	•	•	•		•	•	•	

Kugelkapseln Artikel-Nr. 377... mit extra-starker Öse 0,80 mm stark

Kugelkapseln mit extra starker Öse Ball caps with extra strong ring								
Kapsel-Ø in mm	3,0	3,5	4,0	5,0	3,0	3,5	4,0	5,0
Ösenabmessung in mm	4,0 x 0,8				4,5 x 0,80			
	kleine, offene Öse / small, open ring				große, geschlossene Öse / big, closed ring			
Artikel-Nr.	377A	377B	377C	377D	377E	377F	377G	377H
935 Silber 1 St.	•	•	•	•	•	•	•	•
935 Silber 10 St.	•	•	•	•	•	•	•	•
935 Silber 100 St.	•	•	•	•	•	•	•	•
585 GG 1 St.	•	•	•	•	•	•	•	•
585 GG 10 St.	•	•	•	•	•	•	•	•
750 GG 1 St.	•	•	•	•	•	•	•	•
750 GG 10 St.	•	•	•	•	•	•	•	•
Double 1 St.	•	•	•	•	•	•	•	•
Double 10 St.	•	•	•	•	•	•	•	•
Double 100 St.	•	•	•	•	•	•	•	•



Alle Kapseln sind auch in Silber vergoldet, Silber goldplattiert und Silber rhodiniert lieferbar.
Preise auf Anfrage.



Kugelpapseln Artikel-Nr. 377.../1 - solide, stabile Ausföhrung mit extra-starker Öse 1,0 mm Drahtstärke



kleine, offene Öse
Nr. 377C/1

große, geschlossene Öse
Nr. 377G/1

Kugelpapseln mit extra starker Öse; Drahtstärke Ø 1,0 mm Ball caps with extra strong ring wire Ø 1,0 mm						
	Kapsel-Ø in mm	3,5	4,0	5,0	3,5	4,0
Ösenabmessung in mm	4,0 x 1,0			5,0 x 1,0		
	offene Öse / small, open ring			geschlossene Öse / big, closed ring		
Artikel-Nr.	377B/1	377C/1	377D/1	377F/1	377G/1	377H/1
935 Silber 1 St.	•	•	•	•	•	•
935 Silber 10 St.	•	•	•	•	•	•
935 Silber 100 St.	•	•	•	•	•	•
585 GG 1 St.	•	•	•	•	•	•
750 GG 1 St.	•	•	•	•	•	•



Kugelpapseln Artikel-Nr. 377.../1,4 - solide, stabile Ausföhrung mit extra-starker Öse 1,4 mm Drahtstärke



kleine, offene Öse
Nr. 377C/1,4

große, geschlossene Öse
Nr. 377G/1,4

Kugelpapseln mit extra starker Öse; Drahtstärke Ø 1,4 mm Ball caps with extra strong ring wire Ø 1,4 mm						
	Kapsel-Ø in mm	3,5	4,0	5,0	3,5	4,0
Ösenabmessung in mm	4,8 x 1,4					
	offene Öse / open ring			geschlossene Öse / closed ring		
Artikel-Nr.	377B/1,4	377C/1,4	377D/1,4	377F/1,4	377G/1,4	377H/1,4
935 Silber 1 St.	•	•	•	•	•	•
935 Silber 10 St.	•	•	•	•	•	•
935 Silber 100 St.	•	•	•	•	•	•



Alle Kapseln sind auch in Silber vergoldet, Silber goldplattiert und Silber rhodiniert lieferbar.
Preise auf Anfrage.

SUMA FURNITUREN

Mulde 10 D-75239 Eisingen • ☎ +49 (0) 7232 809 454 • 📠 +49 (0) 7232 809 453 • ✉ info@sumafurnituren.de • www.sumafurnituren.de



Sternkapseln Artikel-Nr. 278... mit Standard-Öse 0,80 mm stark



kleine, offene Öse

große, geschlossene Öse

Sternkapsel mit Öse Squeezing caps with ring						
Kapsel-Ø in mm ca.	3,0	3,5	4,0	3,0	3,5	4,0
	kleine, offene Öse / small, open ring			große, geschlossene Öse / big, closed ring		
Ösenabmessung in mm	Silber: 4,0 x 0,8 Gold: 3,2 x 0,7			Silber: 5,0 x 0,8 Gold: 4,2 x 0,7		
Artikel-Nr.	278A	278B	278C	278D	278E	278F
935 Silber 1 St.	•	•	•	•	•	•
935 Silber 10 St.	•	•	•	•	•	•
935 Silber 100 St.	•	•	•	•	•	•
585 GG 1 St.	•	•	•	•	•	•
585 GG 10 St.	•	•	•	•	•	•
585 WG Pd RH 1 St.	•		•	•		•
585 WG Pd RH 10 St.	•			•		
750 GG 1 St.	•	•	•	•	•	•
750 GG 10 St.	•	•		•	•	







Sternkapseln Artikel-Nr. 378... mit extra-starker Öse 1,0 mm stark







kleine, offene Öse

große, geschlossene Öse





Sternkapsel mit extra starker Öse Squeezing caps with extra strong ring								
Kapsel-Ø in mm ca.	3,0	3,5	4,0	5,0	3,0	3,5	4,0	5,0
	kleine, offene Öse / small, open ring				große, geschlossene Öse / big, closed ring			
Ösenabmessung in mm	4,0 x 1,0				5,0 x 1,0			
Artikel-Nr.	378A	378B	378C	378G	378D	378E	378F	378H
935 Silber 1 St.	•	•	•	•	•	•	•	•
935 Silber 10 St.	•	•	•	•	•	•	•	•
935 Silber 100 St.	•	•	•	•	•	•	•	•





Zylindrische Kapseln mit kleiner, offener Öse Cylindrical caps with small, open ring				
Innen-Ø in mm ca.	2,0	2,5	3,0	4,0
Länge der Kapsel	4,3	4,6	5,0	5,8
Ösenabmessung in mm	3,2 x 0,7	3,2 x 0,7	3,2 x 0,7	3,2 x 0,7
Artikel-Nr.	8220K	8225K	8230K	8240K
935 Silber 1 St.	•	•	•	•
935 Silber 10 St.	•	•	•	•
935 Silber 100 St.	•	•	•	•
585 GG 1 St.	•	•	•	•
750 GG 1 St.	•	•	•	•





Zylindrische Kapseln mit großer, geschlossener Öse Cylindrical caps with big, closed ring				
Innen-Ø in mm ca.	2,0	2,5	3,0	4,0
Länge der Kapsel ca.	4,3	4,6	5,0	5,8
Ösenabmessung in mm	4,5 x 0,7	4,5 x 0,7	4,5 x 0,7	4,5 x 0,7
Artikel-Nr.	8220G	8225G	8230G	8240G
935 Silber 1 St.	•	•	•	•
935 Silber 10 St.	•	•	•	•
935 Silber 100 St.	•	•	•	•
585 GG 1 St.	•	•	•	•
750 GG 1 St.	•	•	•	•





SUMA FURNITUREN







Mulde 10 D-75239 Eisingen • ☎ +49 (0) 7232 809 454 • 📠 +49 (0) 7232 809 453 • ✉ info@sumafurnituren.de • www.sumafurnituren.de









Zylindrische Kapseln mit starker , kleiner, offener Öse Cylindrical caps with strong , small, open ring					
Innen-Ø in mm ca.	2,0	2,5	3,0	4,0	5,0
Länge der Kapsel ca.	4,3	4,6	5,0	5,8	6,6
Ösenabmessung in mm	4,0 x 0,8	4,0 x 0,8	4,0 x 0,8	4,0 x 0,8	4,0 x 0,8
Artikel-Nr.	6220K	6225K	6230K	6240K	6250K
935 Silber 1 St.	•	•	•	•	•
935 Silber 10 St.	•	•	•	•	•
935 Silber 100 St.	•	•	•	•	•



Zylindrische Kapseln mit starker , kleiner, offener Öse Cylindrical caps with strong , small, open ring					
Innen-Ø in mm ca.	6,1	6,5	7,0	8,0	10,1
Länge der Kapsel ca.	7,7	8,0	7,8	10,0	12,0
Ösenabmessung in mm	4,0 x 1,0	4,0 x 1,0	4,0 x 1,0	4,0 x 1,0	4,0 x 1,0
Artikel-Nr.	6260K	6265K	6270K	6280K	82100K
935 Silber 1 St.	•	•	•	•	•
935 Silber 10 St.	•	•	•	•	•



Zylindrische Kapseln mit starker , großer, geschlossener Öse Cylindrical caps with strong , big, closed ring					
Innen-Ø in mm ca.	2,0	2,5	3,0	4,0	5,0
Länge der Kapsel ca.	4,3	4,6	5,0	5,8	6,6
Ösenabmessung in mm	4,5 x 0,8	4,5 x 0,8	4,5 x 0,8	4,5 x 0,8	4,5 x 0,8
Artikel-Nr.	6220G	6225G	6230G	6240G	6250G
935 Silber 1 St.	•	•	•	•	•
935 Silber 10 St.	•	•	•	•	•
935 Silber 100 St.	•	•	•	•	•

Zylindrische Kapseln mit starker , großer, geschlossener Öse Cylindrical caps with strong , big, closed ring					
Innen-Ø in mm ca.	6,3	6,5	7,0	8,0	10,1
Länge der Kapsel ca.	7,8	8,0	7,8	10,0	12,0
Ösenabmessung in mm	5,0 x 1,0	5,0 x 1,0	5,0 x 1,0	5,0 x 1,0	5,0 x 1,0
Artikel-Nr.	6260G	6265G	6270G	6280G	82100G
935 Silber 1 St.	•	•	•	•	•
935 Silber 10 St.	•	•	•	•	•

Endröhrchen End tubes						
Innen-Ø in mm ca.	0,5	0,8	1,2	0,5	0,8	1,2
Außen-Ø x Länge mm ca.	1,5 x 6,0	1,8 x 5,0	1,8 x 6,0	1,5 x 6,0	1,8 x 5,0	1,8 x 6,0
Ösenabmessung in mm	4,0 x 0,8			4,5 x 0,8		
	offene Öse / open ring			geschlossene Öse / closed ring		
Artikel-Nr.	8205K	8208K	8212K	8205G	8208G	8212G
925 Silber 1 St.	•	•	•	•	•	•
925 Silber 10 St.	•	•	•	•	•	•
925 Silber 100 St.	•	•	•	•	•	•

Endkappen, rund End caps, round								
Innen-Ø in mm ca.	1,0	1,5	2,0	2,5	3,0	3,5	4,0	5,0
Artikel-Nr.	308Z	308P	308M	308N	308O	308Q	308R	308S
925 Silber 1 St.	•	•	•	•	•	•	•	•
925 Silber 10 St.	•	•	•	•	•	•	•	•
925 Silber 100 St.	•	•	•	•	•			

Endkappen, konvex abgerundet End caps, convex round edge								
Breite in mm ca.	3	3,5	4	5	6	7		
Artikel-Nr.	2771/3	2771/3,5	2771/4	2771/5	2771/6	2771/7		
925 Silber 1 St.	•	•	•	•	•	•	•	•
925 Silber 10 St.	•	•	•	•	•	•	•	•

Endkappen, konvex gerade Kante End caps, convex straight edge									
Breite in mm ca.	3,5	4	5	6	7	8	10	12	15
Artikel-Nr.	2772/3,5	2772/4	2772/5	2772/6	2772/7	2772/8	2772/10	2772/12	2772/15
925 Silber 1 St.	•	•	•	•	•	•	•	•	•
925 Silber 10 St.	•	•	•	•	•	•	•	•	•

SUMA FURNITUREN

Mulde 10 D-75239 Eisingen • ☎ +49 (0) 7232 809 454 • 📠 +49 (0) 7232 809 453 • ✉ info@sumafurnituren.de • www.sumafurnituren.de

Endkappen, flach abgerundet End caps, flat round edge						
Breite in mm ca.	1,0	1,5	2,0	2,5	3,0	3,5
Artikel-Nr.	2773/1	2773/1,5	2773/2	2773/2,5	2773/3	2773/3,5
925 Silber 1 St.	•	•	•	•	•	•
925 Silber 10 St.	•	•	•	•	•	•
925 Silber 100 St.	•	•	•	•	•	•

Endkappen, flach abgerundet End caps, flat rounded edge						
Breite in mm ca.	4,0	5,0	6,0	7,0	8,0	9,0
Artikel-Nr.	2773/4	2773/5	2773/6	2773/7	2773/8	2773/9
925 Silber 1 St.	•	•	•	•	•	•
925 Silber 10 St.	•	•	•	•	•	•

Gepresste Endkappen mit Öse End caps with ring, stamped version							
Innen-Ø in mm ca.	0,45	0,80	1,0	1,5	2,0	2,5	3,0
Artikel-Nr.	8232A	8232B	8232C	8232D	8232E	8232F	8232G
925 Silber 1 St.	•	•	•	•	•	•	•
925 Silber 10 St.	•	•	•	•	•	•	•
925 Silber 100 St.	•	•	•	•	•	•	•

Klappkapseln Bead tips					
Außen-Ø in mm ca.	4,0	3,0	4,0	4,0	5,0
Artikel-Nr.	1275/4	1276/3	1276/4	1277/4	1277/5
925 Silber 1 St.	•	•	•	•	•
925 Silber 10 St.	•	•	•	•	•
925 Silber 100 St.	•	•	•	•	•

Konische Endkappen Cones				
Länge in mm ca.	13,0	13,0	16,0	18,0
Innen-Ø in mm ca.	3,9	4,8	4,9	5,4
Artikel-Nr.	8215C	8215D	8215E	8215K
925 Silber 1 St.	•	•	•	•
925 Silber 10 St.	•	•	•	•



Fugenloses Charnierrohr Tubes

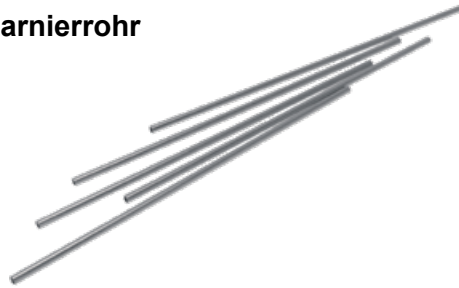

Charnierrohr, rund, glatt Tubes, round, smooth Silber: 20 cm Länge Gold: 10 cm Länge					
Außen-Ø in mm ca.	1,0	1,5	2,0	2,5	3,0
Wandstärke in mm ca.	0,30	0,30	0,30	0,30	0,30
Artikel-Nr.	281A	281B	281C	281D	281E
935 Silber 1 St.	•	•	•	•	•
935 Silber 10 St.		•	•	•	•
585 GG 1 St.	•	•	•	•	•
585 WG 1 St.	•		•		
750 GG 1 St.	•	•	•	•	•

Charnierrohr, rund, glatt Tubes, round, smooth 20 cm Länge					
Außen-Ø in mm ca.	4,0	5,0	6,0	8,0	10,0
Wandstärke in mm ca.	0,30	0,30	0,50	0,50	0,50
Artikel-Nr.	281F	281G	281H	281K	281L
935 Silber 1 St.	•	•	•	•	•
935 Silber 10 St.	•	•	•		

Charnierrohr, quadra- tisch, glatt Tubes, square, smooth 20 cm Länge						
Außen-Ø in mm ca.	2,0 x 2,0	3,0 x 3,0	4,0 x 4,0	4,0 x 4,0	5,0 x 5,0	5,0 x 5,0
Wandstärke in mm ca.	0,3	0,3	0,3	0,5	0,3	0,5
Artikel-Nr.	281CV	281EV	281FV	281FV/0,5	281GV/0,3	281GV
935 Silber 1 St.	•	•	•	•	•	•
935 Silber 10 St.	•	•	•			•

SUMA FURNITUREN

Mulde 10 D-75239 Eisingen • ☎ +49 (0) 7232 809 454 • 📠 +49 (0) 7232 809 453 • ✉ info@sumafurnituren.de • www.sumafurnituren.de



**Blech
Sheet**

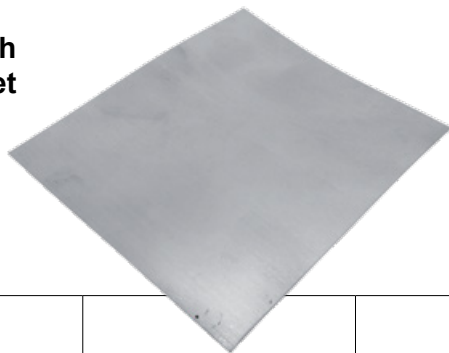

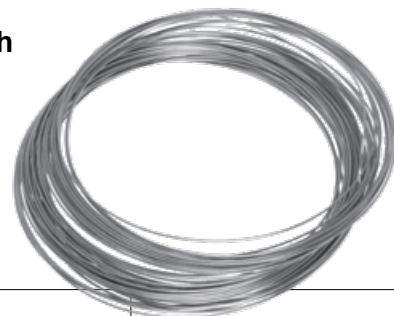

**Draht, weich
Wire, soft**







Blech, weich Sheet, soft				
Dicke in mm ca.	0,5	0,8	1,0	
Silber 10 x 10 cm	ca. 57 g	ca. 86 g	ca. 110 g	
Artikel-Nr.	28205	28208	28210	
935 Silber 1 St.	•	•	•	



Draht, rund, weich ●-Profil Wire, round, soft						
Ø in mm ca.	0,5	0,6	0,7	0,8	0,9	1,0
Artikel-Nr.	28305R	28306R	28307R	28308R	28309R	28310R
935 Silber 10 cm	•	•	•	•	•	•
935 Silber 100 cm	•	•	•	•	•	•
333 GG 1 cm			•	•	•	•
333 GG 10 cm			•	•	•	•
585 GG 1 cm		•	•	•	•	•
585 GG 10 cm		•	•	•	•	•
585 WG 1 cm			•	•	•	•
585 WG 10 cm			•	•	•	•
750 GG 1 cm			•	•	•	•
750 GG 10 cm			•	•	•	•
750 RotG 1 cm			•	•	•	•
750 RotG 10 cm			•	•	•	•
750 WG 1 cm			•	•	•	•
750 WG 10 cm			•	•	•	•

Draht, rund, weich ●-Profil Wire, round, soft							
Ø in mm ca.	1,1	1,2	1,5	1,8	2,0	3,0	4,0
Artikel-Nr.	28311R	28312R	28315R	28318R	28320R	28330R	28340R
935 Silber 10 cm	•	•	•	•	•	•	•
935 Silber 100 cm	•	•	•	•	•	•	•
585 GG 1 cm		•	•				
585 GG 10 cm		•	•				

Draht, vierkant ■-Profil			
Maße in mm ca.	1,5 x 1,5	2,0 x 2,0	2,5 x 2,5
Artikel-Nr.	28315V	28320V	28325V
935 Silber 10 cm	•	•	•
935 Silber 100 cm	•	•	•

Draht, vierkant ■-Profil			
Maße in mm ca.	3,0 x 3,0	4,0 x 4,0	
Artikel-Nr.	28330V	28340V	
935 Silber 10 cm	•	•	
935 Silber 100 cm	•	•	

Draht, halbrund ◐-Profil			
Breite x Höhe in mm ca.	2,0 x 1,0	3,0 x 1,5	
Artikel-Nr.	28320H	28330H	
935 Silber 10 cm	•	•	
935 Silber 100 cm	•	•	



Draht, halbrund ◐-Profil			
Breite x Höhe in mm ca.	4,0 x 1,5	4,0 x 2,0	
Artikel-Nr.	28340H1,5	28340H	
935 Silber 10 cm	•	•	
935 Silber 100 cm	•	•	



SUMA FURNITUREN



Mulde 10 D-75239 Eisingen • ☎ +49 (0) 7232 809 454 • 📠 +49 (0) 7232 809 453 • ✉ info@sumafurnituren.de • www.sumafurnituren.de



Alle Abbildungen sind aufgrund der Detailtreue um ca. 50% vergrößert dargestellt!
The pictures are enlarged for a detailed presentation.

Galerie-Bänder / Borten Gallery / edges			
	Eichenlaub	Lorbeer	Krönchen
Breite in mm ca.	4,5	5,0	5,2
Artikel-Nr.	6422A	6422B	6422C
935 Silber 10 cm	•	•	•
935 Silber 100 cm	•	•	•
935 Silber 500 cm	•	•	•
585 GG 1 cm	•		•
585 GG 10 cm	•		•
750 GG 1 cm		•	•
750 GG 10 cm		•	•
750 WG Pd 1 cm			•
750 WG Pd 10 cm			•

Galerie-Bänder / Borten Gallery / edges			
	Zacken	Girlande	Blumenband
Breite in mm ca.	5,1	5,2	7,0
Artikel-Nr.	6422D	6422E	6422F
935 Silber 10 cm	•	•	•
935 Silber 100 cm	•	•	•
935 Silber 500 cm	•	•	•

Galerie-Bänder / Borten Gallery / edges			
	Röschen	Lilie	Spiegel
Breite in mm ca.	2,9	7,7	7,0
Artikel-Nr.	6422G	6422H	6422I
935 Silber 10 cm	•	•	•
935 Silber 100 cm	•	•	•
935 Silber 500 cm	•	•	•
585 GG 1 cm	•		
585 GG 10 cm	•		
750 GG 1 cm	•		•
750 GG 10 cm	•		•
750 WG Pd 1 cm	•		
750 WG Pd 10 cm	•		



Alle Abbildungen sind aufgrund der Detailtreue um ca. 50% vergrößert dargestellt!
The pictures are enlarged for a detailed presentation.

Galerie-Bänder / Borten Gallery / edges			
	Bordüre	Mondsichel	Blume
Breite in mm ca.	10,5	2,2	5,0
Artikel-Nr.	6422K	6422L	6422M
935 Silber 10 cm	•	•	•
935 Silber 100 cm	•	•	•
935 Silber 500 cm	•	•	•

Galerie-Bänder / Borten Gallery / edges			
	Blumenband einseitig		
Breite in mm ca.	6,0		
Artikel-Nr.	6422N		
935 Silber 10 cm	•		
935 Silber 100 cm	•		
935 Silber 500 cm	•		



Perldraht - rund - massive Ausführung ball wire - round - massive version

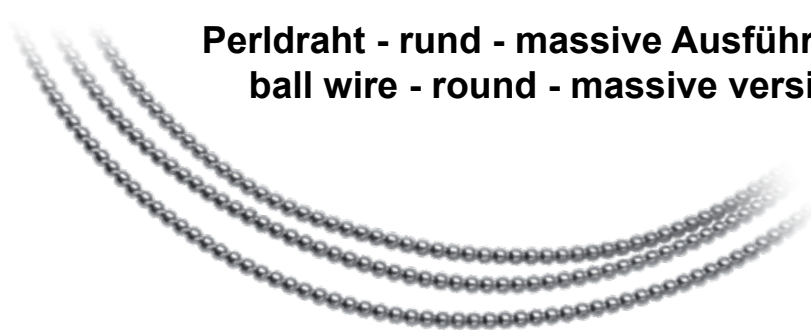

Perldraht, rund, massiv Ball wire, round, massive	NEU				
	0,8	1,0	1,3	1,5	1,75
Ø in mm ca.	0,8	1,0	1,3	1,5	1,75
Artikel-Nr.	286/0,8	286/1	286/1,3	286/1,5	286/1,75
935 Silber 10 cm	•	•	•	•	•
935 Silber 100 cm	•	•	•	•	•
935 Silber 500 cm	•	•	•	•	•
935 Silber 1000 cm	•	•	•	•	•
585 GG 1 cm	•	•	•	•	•
585 GG 10 cm	•	•	•	•	•
585 RoseG 1 cm	•	•	•	•	•
585 RoseG 10 cm	•	•	•	•	•
585 RotG 1 cm	•	•	•	•	•
585 RotG 10 cm	•	•	•	•	•
585 WG Pd 1 cm	•	•	•	•	•
585 WG Pd 10 cm	•	•	•	•	•
750 GG 1 cm	•	•	•	•	•
750 GG 10 cm	•	•	•	•	•
750 RoseG 1 cm	•	•	•	•	•
750 RoseG 10 cm	•	•	•	•	•
750 RotG 1 cm	•	•	•	•	•
750 RotG 10 cm	•	•	•	•	•
750 WG Pd 1 cm	•	•	•	•	•
750 WG Pd 10 cm	•	•	•	•	•
960 Platin 1 cm		•	•	•	•
960 Platin 10 cm		•	•	•	•

Abgeschnittene Perldrahtstücke können weder umgetauscht noch zurückgenommen werden!!



Perldraht - rund - massive Ausführung ball wire - round - massive version

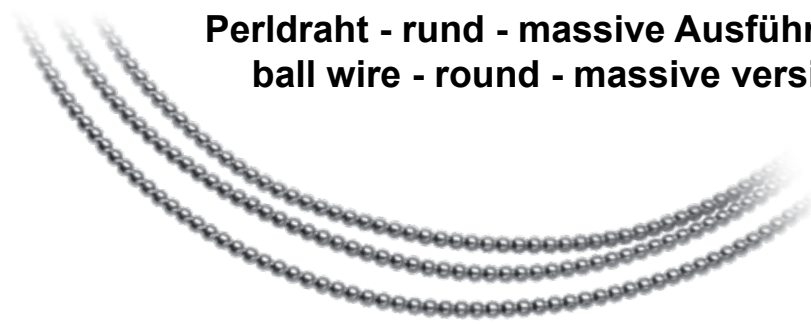

Perldraht, rund, massiv Ball wire, round, massive	NEU			
	2,0	2,25	2,5	3,0
Ø in mm ca.	2,0	2,25	2,5	3,0
Artikel-Nr.	286/2	286/2,25	286/2,5	286/3
935 Silber 10 cm	•	•	•	•
935 Silber 100 cm	•	•	•	•
935 Silber 500 cm	•	•	•	•
935 Silber 1000 cm	•	•	•	•
585 GG 1 cm	•	•	•	•
585 GG 10 cm	•	•	•	•
585 RoseG 1 cm	•	•	•	•
585 RoseG 10 cm	•	•	•	•
585 RotG 1 cm	•	•	•	•
585 RotG 10 cm	•	•	•	•
585 WG Pd 1 cm	•	•	•	•
585 WG Pd 10 cm	•	•	•	•
750 GG 1 cm	•	•	•	•
750 GG 10 cm	•	•	•	•
750 RoseG 1 cm	•	•	•	•
750 RoseG 10 cm	•	•	•	•
750 RotG 1 cm	•	•	•	•
750 RotG 10 cm	•	•	•	•
750 WG Pd 1 cm	•	•	•	•
750 WG Pd 10 cm	•	•	•	•
960 Platin 1 cm	•	•	•	•
960 Platin 10 cm	•	•	•	•

Abgeschnittene Perldrahtstücke können weder umgetauscht noch zurückgenommen werden!!



Kordeldraht - massive Ausführung Twisted wire - massive version

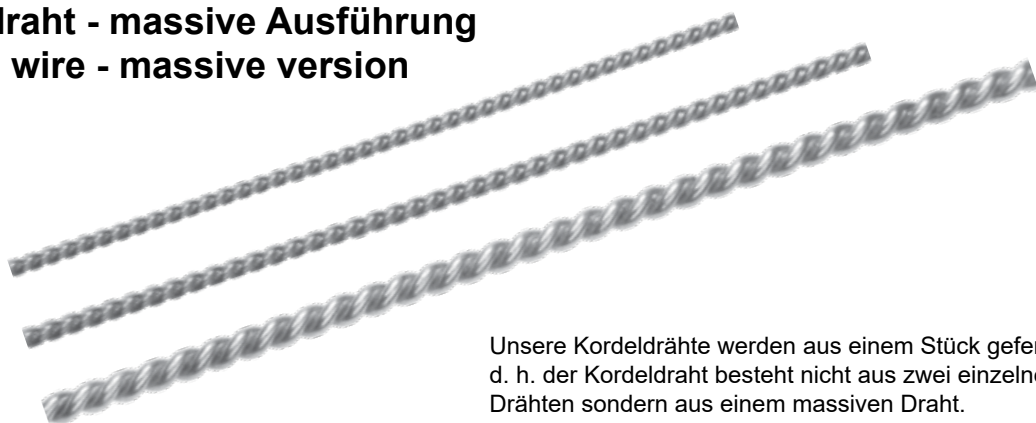

Unsere Kordeldrähte werden aus einem Stück gefertigt, d. h. der Kordeldraht besteht nicht aus zwei einzelnen Drähten sondern aus einem massiven Draht.

Kordeldraht, massiv Twisted wire, massive	NEU	NEU				
	0,9	1,0	1,1	1,3	1,5	1,7
Ø in mm ca.						
Artikel-Nr.	490/0,9	490/1,0	490/1,1	490/1,3	490/1,5	490/1,7
935 Silber 10 cm	•	•	•	•	•	•
935 Silber 100 cm	•	•	•	•	•	•
935 Silber 500 cm	•	•	•	•	•	•
935 Silber 1000 cm	•	•	•	•	•	•
585 GG 1 cm	•	•	•	•	•	•
585 GG 10 cm	•	•	•	•	•	•
585 RoseG 1 cm	•	•	•	•	•	•
585 RoseG 10 cm	•	•	•	•	•	•
585 RotG 1 cm	•	•	•	•	•	•
585 RotG 10 cm	•	•	•	•	•	•
585 WG Pd 1 cm	•	•	•	•	•	•
585 WG Pd 10 cm	•	•	•	•	•	•
750 GG 1 cm	•	•	•	•	•	•
750 GG 10 cm	•	•	•	•	•	•
750 RoseG 1 cm	•	•	•	•	•	•
750 RoseG 10 cm	•	•	•	•	•	•
750 RotG 1 cm	•	•	•	•	•	•
750 RotG 10 cm	•	•	•	•	•	•
750 WG Pd 1 cm	•	•	•	•	•	•
750 WG Pd 10 cm	•	•	•	•	•	•
960 Platin 1 cm						•
960 Platin 10 cm						•





Abgeschnittene Kordeldrahtstücke können weder umgetauscht noch zurückgenommen werden!!

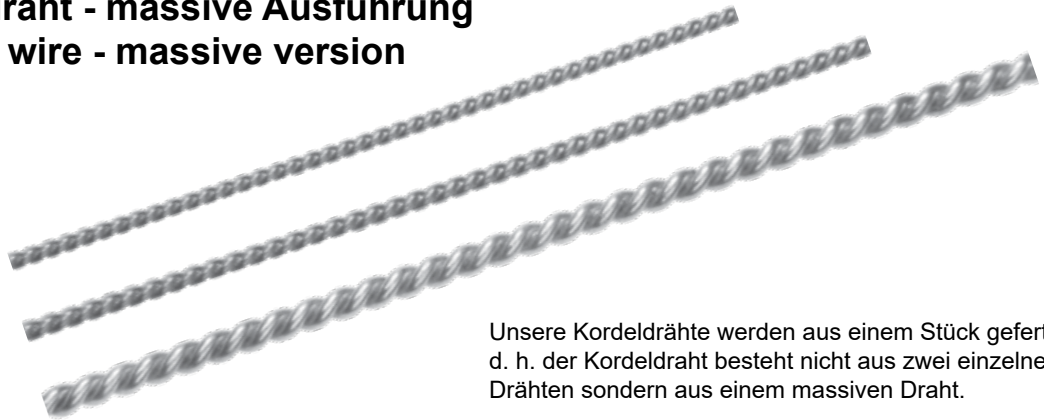

Kordeldraht - massive Ausführung Twisted wire - massive version



Unsere Kordeldrähte werden aus einem Stück gefertigt, d. h. der Kordeldraht besteht nicht aus zwei einzelnen Drähten sondern aus einem massiven Draht.

Kordeldraht, massiv Twisted wire, massive					
Ø in mm ca.	1,9	2,1	2,3	2,5	3,0
Artikel-Nr.	490/1,9	490/2,1	490/2,3	490/2,5	490/3,0
935 Silber 10 cm	•	•	•	•	•
935 Silber 100 cm	•	•	•	•	•
935 Silber 500 cm	•	•	•	•	•
935 Silber 1000 cm	•	•	•	•	•
585 GG 1 cm	•	•	•	•	•
585 GG 10 cm	•	•	•	•	•
585 RoseG 1 cm	•	•		•	
585 RoseG 10 cm	•	•		•	
585 RotG 1 cm	•	•	•	•	
585 RotG 10 cm	•	•	•	•	
585 WG Pd 1 cm	•	•	•		
585 WG Pd 10 cm	•	•	•		
750 GG 1 cm	•	•	•	•	•
750 GG 10 cm	•	•	•	•	•
750 RoseG 1 cm	•	•			
750 RoseG 10 cm	•	•			
750 RotG 1 cm	•	•			
750 RotG 10 cm	•	•			
750 WG Pd 1 cm	•	•			
750 WG Pd 10 cm	•	•			

Abgeschnittene Kordeldrahtstücke können weder umgetauscht noch zurückgenommen werden!!





Kordeldraht weit - massive Ausführung Twisted wire wide - massive version



Nr. 491/2

Unsere Kordeldrähte werden aus einem Stück gefertigt, d. h. der Kordeldraht besteht nicht aus zwei einzelnen Drähten sondern aus einem massiven Draht.

Kordeldraht, massiv Twisted wire, massive			
Ø in mm ca.	1,3	1,5	1,75
Artikel-Nr.	491/1,3	491/1,5	491/1,75
935 Silber 10 cm	•	•	•
935 Silber 100 cm	•	•	•
935 Silber 500 cm	•	•	•
935 Silber 1000 cm	•	•	•
585 GG 1 cm	•	•	•
585 GG 10 cm	•	•	•
585 RotG 1 cm			•
585 RotG 10 cm			•
585 WG Pd 1 cm	•		•
585 WG Pd 10 cm	•		•
750 GG 1 cm	•	•	•
750 GG 10 cm	•	•	•
750 RoseG 1 cm			•
750 RoseG 10 cm			•
750 RotG 1 cm		•	
750 RotG 10 cm		•	
750 WG Pd 1 cm			•
750 WG Pd 10 cm			•

Weite Kordeldrähte in Goldlegierungen: auf Anfrage!

Abgeschnittene Kordeldrahtstücke können weder umgetauscht noch zurückgenommen werden!!





Kordeldraht weit - massive Ausführung Twisted wire wide - massive version



Nr. 491/2

Unsere Kordeldrähte werden aus einem Stück gefertigt, d. h. der Kordeldraht besteht nicht aus zwei einzelnen Drähten sondern aus einem massiven Draht.

Kordeldraht, massiv Twisted wire, massive			
Ø in mm ca.	2,0	2,5	
Artikel-Nr.	491/2	491/2,5	
935 Silber 10 cm	•	•	
935 Silber 100 cm	•	•	
935 Silber 500 cm	•	•	
935 Silber 1000 cm	•	•	
585 GG ab 1 cm	•		
585 GG ab 10 cm	•		
585 RoseG 1 cm	•		
585 RoseG 10 cm	•		
585 RotG 1 cm	•		
585 RotG 10 cm	•		
585 WG Pd ab 1 cm	•		
585 WG Pd ab 10 cm	•		
750 GG ab 1 cm	•		
750 GG ab 10 cm	•		
750 WG Pd ab 1 cm	•		
750 WG Pd ab 10 cm	•		
960 Platin 1 cm	•		
960 Platin 10 cm	•		

Weite Kordeldrähte in Goldlegierungen: auf Anfrage!

Abgeschnittene Kordeldrahtstücke können weder umgetauscht noch zurückgenommen werden!!

Eierstabdraht - massive Ausführung - mit Doppelring Egg shaped wire - massive version - with 2 rings



Nr. 495/2

Eierstabdraht Egg shape wire			
Ø in mm ca.	1,0	1,3	1,5
Artikel-Nr.	495/1	495/1,3	495/1,5
935 Silber 10 cm	•	•	•
935 Silber 100 cm	•	•	•
935 Silber 500 cm	•	•	•
585 GG 1 cm	•	•	•
585 GG 10 cm	•	•	•
585 RoseG 1 cm	•	•	•
585 RoseG 10 cm	•	•	•
585 RotG 1 cm			•
585 RotG 10 cm			•
585 WG Pd 1 cm	•	•	•
585 WG Pd 10 cm	•	•	•
750 GG 1 cm	•	•	•
750 GG 10 cm	•	•	•
750 RoseG 1 cm			•
750 RoseG 10 cm			•

Eierstabdraht Egg shape wire			
Ø in mm ca.	1,75	2,0	
Artikel-Nr.	495/1,75	495/2	
935 Silber 10 cm	•	•	
935 Silber 100 cm	•	•	
585 GG 1 cm	•	•	
585 GG 10 cm	•	•	
585 RoseG 1 cm		•	
585 RoseG 10 cm		•	
585 RotG 1 cm	•		
585 RotG 10 cm	•		
585 WG Pd 1 cm	•	•	
585 WG Pd 10 cm	•	•	
750 GG 1 cm	•	•	
750 GG 10 cm	•	•	

Eierstabdrähte in weiteren Goldlegierungen: auf Anfrage!

Abgeschnittene Eierstabdrahtstücke können weder umgetauscht noch zurückgenommen werden!!

Eierstabdraht - massive Ausführung - mit Einfachring Egg shaped wire - massive version - with 1 ring



Nr. 496/2,5

Eierstabdraht Egg shape wire			
Ø in mm ca.	1,5	2,0	2,5
Artikel-Nr.	496/1,5	496/2	496/2,5
935 Silber 10 cm	•	•	•
935 Silber 100 cm	•	•	•
585 GG 1 cm		•	
585 GG 10 cm		•	
750 GG 1 cm	•	•	•
750 GG 10 cm	•	•	•

Eierstabdrähte in weiteren Goldlegierungen: auf Anfrage!

NEU

Olivdraht - massive Ausführung olive wire - massive version













Nr. 497/2

Olivdraht Egg shape wire			
Ø in mm ca.	1,3	1,5	1,75
Artikel-Nr.	497/1,3	497/1,5	497/1,75
935 Silber 10 cm	•	•	•
935 Silber 100 cm	•	•	•
935 Silber 500 cm	•	•	•
585 GG 1 cm	•	•	•
585 GG 10 cm	•	•	•
585 RoseG 1 cm		•	
585 RoseG 10 cm		•	
585 WG Pd 1 cm		•	•
585 WG Pd 10 cm		•	•
750 GG 1 cm	•	•	•
750 GG 10 cm	•	•	•

Olivdraht Egg shape wire			
Ø in mm ca.	2,0		
Artikel-Nr.	497/2		
935 Silber 10 cm	•		
935 Silber 100 cm	•		
935 Silber 500 cm	•		
585 GG 1 cm	•		
585 GG 10 cm	•		
585 RoseG 1 cm	•		
585 RoseG 10 cm	•		
750 GG 1 cm	•		
750 GG 10 cm	•		





Olivdrähte in weiteren Goldlegierungen: auf Anfrage!





Krawattennadelstiele (ca. Ø 1,0 mm), Nadelsicherung Tie pins (ca. Ø 1,0 mm), Pin protectors					
				mit Gummieinlage / rubber insert	
Außen-Ø / Länge mm ca.	55	50	50	2,5 x 10,5 mm	4,6 x 11 mm
für Nadel-Ø in mm ca.				0,7	1,0
Artikel-Nr.	228	228	229	240E	240F
935 Silber 1 St.	•		•		
935 Silber 10 St.	•		•		
935 Silber 100 St.	•		•		
333 GG 1 St.		•			
585 GG 1 St.		•			
585 WG Pd 1 St.		•			
750 GG 1 St.		•			
750 WG Pd 1 St.		•			
Messing VS 1 St.				•	•
Messing VS 10 St.				•	•
Messing VG 1 St.				•	
Messing VG 10 St.				•	





Knopfsicherungen, Stifte für Knopf- sicherung Grip fasteners, Pins for grip fasteners						
	Ø x Höhe / Länge x Ø x Platten-Ø in mm ca.	10,5 x 7,0	10,0 x 4,5	SET: Sicherung 10,0 x 4,5 Stift: 121/8	7,0 x 1,1 x 2,0	8,0 x 1,1 x 2,3
Artikel-Nr.	120MF	120P	120P	121/7	121/8	121/10
935 Silber 1 St.			•		•	•
935 Silber 10 St.			•		•	•
935 Silber 100 St.			•		•	•
Messing 10 St.				•	•	•
Messing 100 St.				•	•	•
Messing VS 1 St.	•	•				
Messing VS 10 St.	•	•				
Messing VS 100 St.	•	•				
Messing VG 1 St.	•	•				
Messing VG 10 St.	•	•				
Messing VG 100 St.	•	•				
585 GG 1 St.						

SUMA FURNITUREN

Mulde 10 D-75239 Eisingen • ☎ +49 (0) 7232 809 454 • 📠 +49 (0) 7232 809 453 • ✉ info@sumafurnituren.de • www.sumafurnituren.de

Kugelsicherungen Brooch safety catches					
Kugel-Ø / Höhe / Breite in mm ca.	2,7 / 3,7 / 3,0	3,4 / 5,2 / 3,6	4,0 / 5,5 / 4,2	4,1 / 6,0 / 4,6	3,4 / 5,2 / 3,6
Artikel-Nr.	173/95	173	173/82	173/23	173PL
935 Silber 1 St.	•	•	•	•	•
935 Silber 10 St.	•	•	•	•	•
935 Silber 100 St.	•	•	•		
585 GG 1 St.	•	•	•	•	
585 WG Pd 1 St.	•	•			
750 GG 1 St.	•	•	•	•	
750 WG Pd 1 St.	•	•			

Broschscharnier Brooch joints					
Ø x Höhe in mm ca.	3,0 x 4,0	3,0 x 4,5	3,8 x 4,5	3,5 x 4,0	3,0 x 4,0 Platten-Ø 6 mm
Obere Öffnung Innen / Fußbreite in mm ca.	2,0 / 1,6	1,4 / 2,3	1,5 / 1,9	1,6 / 1,8	2,0 / 1,6
Artikel-Nr.	175	175/4	175/90	175/93	175PL
935 Silber 1 St.	•	•	•	•	•
935 Silber 10 St.	•	•	•	•	•
935 Silber 100 St.	•	•	•	•	
585 GG 1 St.	•	•		•	
750 GG 1 St.	•				

Broschscharniere mit Mittellaufteil Brooch joints with middle part					
Ø x Höhe in mm ca.	3,2 x 3,8	3,3 x 4,0	3,0 x 3,6	2,8 x 3,0	2,8 x 3,0
Artikel-Nr.	165/13	165/24	165/25	165/26	165/75
935 Silber 1 St.	•		•		•
935 Silber 10 St.	•		•		•
585 GG 1 St.	•	•		•	•
585 WG Pd 1 St.				•	
750 GG 1 St.	•		•	•	•
750 WG Pd 1 St.			•		



Nr. 177







Nr. 177/103



Nr. 177/85



Nr. 177/37

Schiebesicherungen Tube Brooch Catches				
Abmessungen in mm ca.				
offen:	11,2	11,2	10,0	12,0
geschlossen:	7,5	7,2	6,6	7,5
Höhe:	5,1	5,1	4,3	4,5
Durchmesser	2,0	2,0	2,0	2,0
max. Nadel-Ø in mm ca.	1,4	1,4	1,4	1,4
Artikel-Nr.	177	177/103	177/85	177/37
935 Silber 1 St.	•	•	•	•
935 Silber 10 St.	•	•	•	•
333 GG 1 St.	•		•	
585 GG 1 St.	•	•		•
585 WG Pd 1 St.	•	•		
750 GG 1 St.	•	•		•
750 WG Pd 1 St.	•	•		



Broschnadeln Brooch needles









Unsere Broschnadeln werden bereits mit einfiniertem Querstift geliefert.
Our brooch needles will be supplied with insert pin.





Broschnadeln Draht-Ø: 0,9 mm Brooch needles wire Ø: 0,9 mm						
Länge in mm ca.	20,0	25,0	30,0	35,0	40,0	50,0
Artikel-Nr.	210/20	210/25	210/30	210/35	210/40	210/50
935 Silber 1 St.	•	•	•	•	•	•
935 Silber 10 St.	•	•	•	•	•	•
935 Silber 100 St.	•	•	•	•	•	•
585 GG 1 St.	•		•		•	





Broschierungen Brooches						
	Stegbreite x -stärke: 2,5 x 1,0 mm, Nadel-Ø 1,0 mm plate: 2,5 x 1,0 mm, needle-Ø: 1,0 mm					
Länge in mm ca.	20,0	25,0	30,0	35,0	40,0	50,0
Artikel-Nr.	220/20	220/25	220/30	220/35	220/40	220/50
935 Silber 1 St.	•	•	•	•	•	•
935 Silber 10 St.	•	•	•	•	•	•
Messing 1 St.	•*					* = nur noch aus Vorrat
Messing 10 St.	•*					* = nur noch aus Vorrat





SUMA FURNITUREN

Mulde 10 D-75239 Eisingen • ☎ +49 (0) 7232 809 454 • 📠 +49 (0) 7232 809 453 • ✉ info@sumafurnituren.de • www.sumafurnituren.de

Manschettenknopf- mechaniken Cuff link backs						
Maße Knebel in mm ca.	17,5 lang 3,6 x 3,6	17,5 lang 3,6 x 3,6	17,5 lang 3,6 x 3,6	19,0 lang 3,7 x 3,2	19,0 lang 3,7 x 3,2	19,0 lang 3,7 x 3,2
Maße Bügel in mm ca.	18,0 x 6,35	18,0 x 6,8	18,0 x 6,8	18,0 x 6,35	18,0 x 6,8	18,0 x 6,8
Artikel-Nr.	290A	290A2	290A3	290B	290B2	290B3
935 Silber 1 St.	•	•	•	•	•	•
935 Silber 10 St.	•	•	•	•	•	•
935 Silber 100 St.	•	•	•	•	•	•
585 GG 1 St.	•	•	•	•	•	•
585 WG Pd 1 St.	•	•	•	•	•	•
750 GG 1 St.	•		•	•		•
750 RotG 1 St.	•					
750 WG Pd 1 St.	•	•	•	•	•	•

Manschettenknopf- mechaniken Cuff link backs						
Maße Knebel in mm ca.	17,5 lang Ø 3,6	17,5 lang Ø 3,6	17,5 lang Ø 3,6		15,7 lang Ø 3,0	
Maße Bügel in mm ca.	18,0 x 6,35	18,0 x 6,8	18,0 x 6,8		15,4 x 2,15	
Artikel-Nr.	290W	290W2	290W3		290I	
935 Silber 1 St.	•	•	•		•	
935 Silber 10 St.	•	•	•		•	
935 Silber 100 St.	•	•	•		•	
585 GG 1 St.	•	•	•		•	
585 WG Pd 1 St.					•	
750 GG 1 St.					•	
750 WG Pd 1 St.					•	







Manschettenknopfmechaniken auf Platte Cuff link backs on plate						
Platten-Ø in mm ca.	6,0	6,0	8,0	10,0	12,0	
Artikel-Nr.	290C	290C2	290C/8	290C/10	290C/12	
935 Silber 1 St.	•	•	•	•	•	
935 Silber 10 St.	•	•	•	•	•	
935 Silber 100 St.	•	•	•	•	•	

Manschettenknopfmechaniken auf Platte Cuff link backs on plate						
Platten-Ø in mm ca.	6,0	6,0	8,0	10,0	12,0	
Artikel-Nr.	290D	290D2	290D/8	290D/10	290D/12	
935 Silber 1 St.	•	•	•	•	•	
935 Silber 10 St.	•	•	•	•	•	
935 Silber 100 St.	•	•	•	•	•	

Manschettenknopfmechaniken auf Platte Cuff link backs on plate						
Platten-Ø in mm ca.	5,0					
Artikel-Nr.	290J					
935 Silber 1 St.	•					
935 Silber 10 St.	•					
935 Silber 100 St.	•					

SUMA FURNITUREN

Mulde 10 D-75239 Eisingen • ☎ +49 (0) 7232 809 454 • 📠 +49 (0) 7232 809 453 • ✉ info@sumafurnituren.de • www.sumafurnituren.de

Manschettenknopfmechaniken mit runder Fassung Cuff link backs with round setting						
Fassung-Ø in mm ca.	12,0	13,0	15,0	12,0	13,0	15,0
Artikel-Nr.	289C/12	289C/13	289C/15	289D/12	289D/13	289D/15
935 Silber 1 St.	•	•	•	•	•	•
935 Silber 10 St.	•	•	•	•	•	•







Platten für Manschettenknopfmechaniken
z.B. Artikel-Nr. 290G



Plates for cuff link backs
e.g. Nr. 290G





Rückseite 290G / back 290G

Manschettenknopfmechaniken - Brücke, Steg und Platte Cuff link backs - bridges, plate						
Maße in mm ca.	9,2 x 3,0	16,0 / 3 mm oben 5 mm unten	20,0 x 9,0 flach	19,8 x 9,2 gewölbt		
Artikel-Nr.	290E	290F	290G	290S		
935 Silber 1 St.	•	•	•	•		
935 Silber 10 St.	•	•	•	•		
585 GG 1 St.	•	•	•			
750 GG 1 St.	•	•	•			
750 WG Pd 1 St.	•	•	•			



Krawattenschieber Tie holder		
Länge in mm ca.	55,0	55,0
Breite in mm ca.	5,2	4,2
Materialstärke in mm ca.	1,0	1,0
Artikel-Nr.	292E	292F
935 Silber 1 St.	•	•
935 Silber 10 St.	•	•

Krawattenklemmsicherung Safety fitting for tie slide		
Abmessungen außen in mm ca.	23,3 x 12,0	23,3 x 12,0 / Kette: 5cm
Kreis Innen-Ø in mm ca.	10,0	
Artikel-Nr.	290H	290K
935 Silber 1 St.	•	•
935 Silber 10 St.	•	•
935 Silber 100 St.	•	•
585 GG 1 St.	•	•



Krawattenklammern Tie holder			
Länge in mm ca.	55	40	20
Artikel-Nr.	292A	292B *	292G *
935 Silber 1 St.	•	•	•
935 Silber 10 St.	•	•	•
		* = nur noch aus Vorrat	* = nur noch aus Vorrat



SUMA FURNITUREN

Mulde 10 D-75239 Eisingen • ☎ +49 (0) 7232 809 454 • 📠 +49 (0) 7232 809 453 • ✉ info@sumafurnituren.de • www.sumafurnituren.de

Ringeinlagen Inlay for rings			
Abmessungen in mm ca.	16 x 5,5 x 2,0	20 x 7,5 x 2,5	
Artikel-Nr.	2750	275P	
935 Silber 1 St.	•	•	
935 Silber 10 St.	•	•	
585 GG 1 St.	•	•	

Schlüsselkette Key ring chain			
Kette	Ankerkette, ca. 14,5 cm lang		
Artikel-Nr.	5010		
925 Silber 1 St.	•		

Schlüsselspaltringe, flach Key rings, flat			
	Außen-Ø in mm ca.	20	26
Breite in mm ca.	2,1	2,6	2,6
Höhe in mm ca.	2,0	2,5	2,5
Artikel-Nr.	5113A/20	5113B/26	5113B/30
925 Silber 1 St.	•	•	•
925 Silber 10 St.	•	•	•
585 GG 1 St.	•	•	•
750 GG 1 St.	•	•	•
Edelstahl 1 St.		•	•
Edelstahl 10 St.		•	•

Schlüsselspaltringe, flach Key rings, flat			
	Außen-Ø in mm ca.	30	35
Breite in mm ca.	3,2	3,2	3,3
Höhe in mm ca.	3,3	3,3	3,4
Artikel-Nr.	5113C/30	5113C/35	5113C/43
925 Silber 1 St.	•	•	•
925 Silber 10 St.	•	•	•







Schlüsselringe in Gold





Auf Wunsch können alle hier abgebildeten Schlüsselringe auch in Gold hergestellt werden.



SUMA FURNITUREN

Mulde 10 D-75239 Eisingen • ☎ +49 (0) 7232 809 454 • 📠 +49 (0) 7232 809 453 • ✉ info@sumafurnituren.de • www.sumafurnituren.de

Schlüsselspaltringe, flach Key rings, flat			
	Außen-Ø in mm ca.	38	43
Breite in mm ca.	4,2	3,3	
Höhe in mm ca.	3,6	4,3	
Artikel-Nr.	5113D/38	5113D/43	
925 Silber	1 St.	•	•
925 Silber	10 St.	•	•







Schlüsselspaltringe, flach mit Kette Key rings, flat, with chain			
	Außen-Ø in mm ca.	26	35
Breite in mm ca.	2,6	3,2	
Höhe in mm ca.	2,5	3,3	
Artikel-Nr.	5113B/26/17120	5113C/35/13150R	
925 Silber	1 St.	•	•
925 Silber	10 St.	•	•







Schlüsselring Key ring					
	Abmessung ca.	Ø 30 mm			
Kette	ohne Kette	Anker 150 rund	Anker 150 flach	Anker 180 rund	Panzer 150 rund
Artikel-Nr.	296F/oK	296F/17150-4K	296F/17150F-4K	296F/17180-4K	296F/13150R-4K
925 Silber 1 St.	•	•	•	•	•
925 Silber 10 St.	•	•	•	•	•
585 GG 1 St.	•				
750 GG 1 St.	•				
750 WG Pd 1 St.	•				



Schlüsselring Key ring					
	Abmessung ca.	40 mm			
Kette	ohne Kette	Anker 150 rund	Anker 180 rund		
Artikel-Nr.	296E/oK	296E/17150-4K	296E/17180-4K		
925 Silber 1 St.	•	•	•		
925 Silber 10 St.	•	•	•		

SUMA FURNITUREN

Mulde 10 D-75239 Eisingen • ☎ +49 (0) 7232 809 454 • 📠 +49 (0) 7232 809 453 • ✉ info@sumafurnituren.de • www.sumafurnituren.de

Verlängerungsketten mit Kugeln Extension chains with ball								
	Kugel-Ø in mm ca.	4	4	3	4	4	4	4
	Kettenbreite in mm ca.	3,2	3,8	3,8	4,5	3,5	3,8	3,8
	Gesamtlänge in mm ca.	55	55	55	55	55	60	65
	Artikel-Nr.	305B	305C	305C	305G	305F	305H	305I
	925 Silber 1 St.	•	•		•	•	•	•
	925 Silber 10 St.	•	•		•	•	•	•
925 Silber VG 1 St.	•	•		•	•	•	•	
925 Silber VG 10 St.	•	•		•	•	•	•	
333 GG 1 St.			•					
585 GG 1 St.			•					

Verlängerungsketten mit Kugeln Extension chains with ball							
	Kugel-Ø in mm ca.	4	4	3	4	4	4
	Kettenbreite in mm ca.	3,2	3,8	3,8	4,5	3,5	3,5
	Gesamtlänge in mm ca.	70	70	70	70	70	65
	Artikel-Nr.	304B	304C	304C	304G	304F	305E
	925 Silber 1 St.	•	•		•	•	•
	925 Silber 10 St.	•	•		•	•	•
925 Silber VG 1 St.	•	•		•	•	•	
925 Silber VG 10 St.	•	•		•	•	•	
333 GG 1 St.			•				
585 GG 1 St.			•				

Sicherheitsketten Safety Chains						
	Gesamtlänge in mm ca.	70,0	70,0	70,0		
	Panzerkette P 35	Ankerkette A 40	Ankerkette A 40			
Artikel-Nr.	306A	306B	306C			
925 Silber 1 St.	•	•	•			
925 Silber 10 St.	•	•	•			
333 GG 1 St.	•	•	•			
585 GG 1 St.	•	•	•			
750 GG 1 St.	•	•	•			

SUMA FURNITUREN

Mulde 10 D-75239 Eisingen • ☎ +49 (0) 7232 809 454 • 📠 +49 (0) 7232 809 453 • ✉ info@sumafurnituren.de • www.sumafurnituren.de

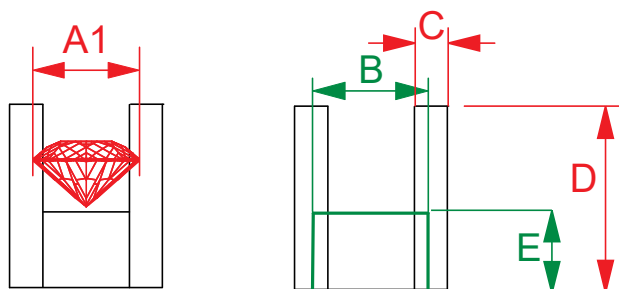
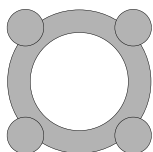

Diese Chatonserie ist aus einem Stück gestanz und gepresst. Der Chaton besteht nicht aus Einzelteilen. Somit können Sie daran löten.

Chatons, gerade, 4 Stotzen Settings, 4-prongs							
A1) Steinmaß in mm ca.		1,75	2,0	2,35	2,55	2,7	2,9
B) Steinauflage in mm		1,75	2,0	2,35	2,55	2,7	2,9
C) Stotzen-Ø in mm		0,63	0,64	0,68	0,72	0,75	0,75
D) Gesamthöhe in mm		2,65	3,0	3,3	3,8	3,8	4,4
E) Zargenhöhe in mm		1,15	1,3	1,6	1,9	1,85	2,0
Artikel-Nr.		280/1	280/1,25	280/1,5	280/1,75	280/1,85	280/2
935 Silber	1 St.	•	•	•	•	•	•
935 Silber	10 St.	•	•	•	•	•	•
585 GG	1 St.	•	•	•	•	•	•
585 GG	10 St.	•	•	•	•	•	•
585 WG Pd	1 St.	•	•	•	•	•	•
585 WG Pd	10 St.	•	•	•	•	•	•
750 GG	1 St.	•	•	•	•	•	•
750 WG Pd	1 St.	•	•	•	•	•	•

Chatons, gerade, 4 Stotzen Settings, 4-prongs							
A1) Steinmaß in mm ca.		3,1	3,5	3,7	4,0	4,3	4,5
B) Steinauflage in mm		3,1	3,45	3,65	4,0	4,3	4,5
C) Stotzen-Ø in mm		0,75	0,85	0,85	1,0	1,0	1,0
D) Gesamthöhe in mm		4,5	5,0	5,15	5,5	5,8	6,2
E) Zargenhöhe in mm		2,0	2,5	2,45	2,85	3,0	3,0
Artikel-Nr.		280/2,25	280/2,5	280/2,75	280/3	280/3,25	280/3,5
935 Silber	1 St.	•	•	•	•	•	•
935 Silber	10 St.	•	•	•	•	•	•
585 GG	1 St.	•	•	•	•	•	•
585 GG	10 St.	•	•	•	•	•	•
585 WG Pd	1 St.	•	•	•	•	•	•
585 WG Pd	10 St.	•	•	•	•	•	•
750 GG	1 St.	•	•	•	•	•	•
750 WG Pd	1 St.	•	•	•	•	•	•

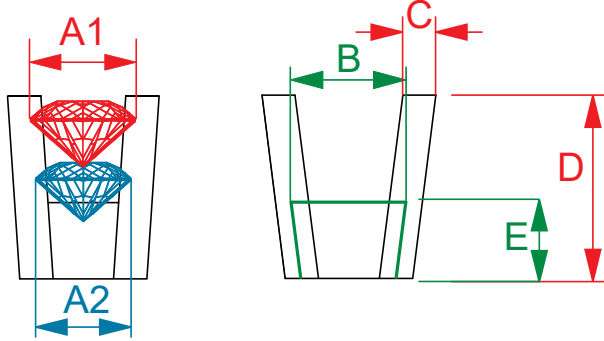
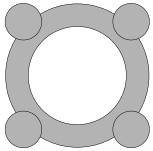

Diese Chatonserie ist aus einem Stück gestanz und gepresst. Der Chaton besteht nicht aus Einzelteilen. Somit können Sie daran löten.

Chatons, konisch, 4 Stotzen Settings, 4-prongs						
A1) Steinmaß in mm ca.		1,8	2,0	2,2	2,8	3,0
A2) Steinmaß in mm ca.		1,5	1,7	1,9	2,5	2,7
B) Steinauflage in mm		1,5	1,7	1,9	2,5	2,65
C) Stotzen-Ø in mm		0,62	0,62	0,62	0,65	0,7
D) Gesamthöhe in mm		2,7	2,7	2,7	3,6	3,9
E) Zargenhöhe in mm		1,2	1,3	1,3	1,8	1,8
Artikel-Nr.		281/1,25	281/1,5	281/1,75	281/2	281/2,25
935 Silber	1 St.	•	•	•	•	•
935 Silber	10 St.	•	•	•	•	•
585 GG	1 St.	•	•	•	•	•
585 GG	10 St.	•	•	•	•	•
585 WG Pd	1 St.	•	•	•	•	•
585 WG Pd	10 St.	•	•	•	•	•
750 GG	1 St.	•	•	•	•	•
750 WG Pd	1 St.	•	•	•	•	•

Chatons, konisch, 4 Stotzen Settings, 4-prongs						
A1) Steinmaß in mm ca.		3,1	3,2	3,5	3,7	4,0
A2) Steinmaß in mm ca.		2,8	2,9	3,2	3,4	3,7
B) Steinauflage in mm		2,8	2,9	3,2	3,35	3,75
C) Stotzen-Ø in mm		0,7	0,7	0,7	0,7	0,75
D) Gesamthöhe in mm		4,4	4,4	4,5	4,4	4,8
E) Zargenhöhe in mm		2,4	2,4	2,4	2,5	2,6
Artikel-Nr.		281/2,5	281/2,75	281/3	281/3,25	281/3,5
935 Silber	1 St.	•	•	•	•	•
935 Silber	10 St.	•	•	•	•	•
585 GG	1 St.	•	•	•	•	•
585 GG	10 St.	•	•	•	•	•
585 WG Pd	1 St.	•	•	•	•	•
585 WG Pd	10 St.	•	•	•	•	•
750 GG	1 St.	•	•	•	•	•
750 WG Pd	1 St.	•	•	•	•	•

SUMA FURNITUREN

Mulde 10 D-75239 Eisingen • ☎ +49 (0) 7232 809 454 • 📠 +49 (0) 7232 809 453 • ✉ info@sumafurnituren.de • www.sumafurnituren.de

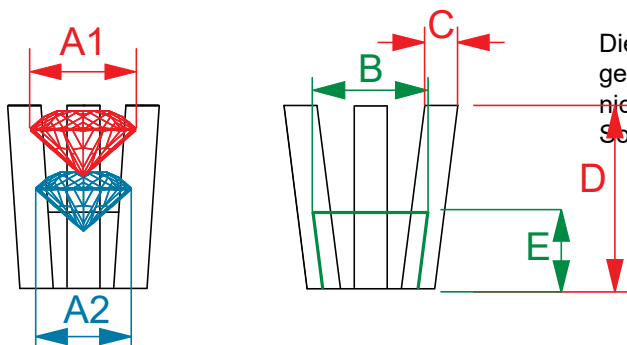
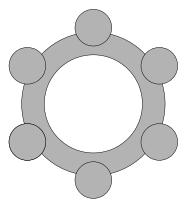

Diese Chatonserie ist aus einem Stück gestanz und gepresst. Der Chaton besteht nicht aus Einzelteilen. Somit können Sie daran löten.

Chatons, konisch, 6 Stotzen Settings, 6-prongs						
A1) Steinmaß in mm ca.		2,4	2,7	2,9	3,0	3,2
A2) Steinmaß in mm ca.		2,1	2,4	2,6	2,7	2,9
B) Steinauflage in mm		2,1	2,4	2,6	2,7	2,9
C) Stotzen-Ø in mm		0,57	0,62	0,62	0,62	0,65
D) Gesamthöhe in mm		3,6	3,8	3,8	4,1	4,7
E) Zargenhöhe in mm		1,6	1,7	1,8	1,9	2,0
Artikel-Nr.		282/2	282/2,25	282/2,5	282/2,75	282/3
935 Silber	1 St.	•	•	•	•	•
935 Silber	10 St.	•	•	•	•	•
585 GG	1 St.	•	•	•	•	•
585 WG Pd	1 St.	•	•	•	•	•
750 GG	1 St.	•	•	•	•	•
750 WG Pd	1 St.	•	•	•	•	•

Chatons, konisch, 6 Stotzen Settings, 6-prongs						
A1) Steinmaß in mm ca.		3,6	4,0	4,3	4,5	
A2) Steinmaß in mm ca.		3,3	3,7	4,0	4,2	
B) Steinauflage in mm		3,3	3,7	4,0	4,2	
C) Stotzen-Ø in mm		0,72	0,72	0,82	0,82	
D) Gesamthöhe in mm		4,9	5,1	5,4	5,9	
E) Zargenhöhe in mm		2,3	2,5	2,7	2,9	
Artikel-Nr.		282/3,25	282/3,5	282/3,75	282/4	
935 Silber	1 St.	•	•	•	•	
935 Silber	10 St.	•	•	•	•	
585 GG	1 St.	•	•	•	•	
585 WG Pd	1 St.	•	•	•	•	
750 GG	1 St.	•	•	•	•	
750 WG Pd	1 St.	•	•	•	•	

NEU Guss-Chatons, 4 Stotzen, gerade

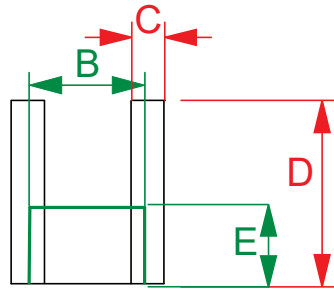
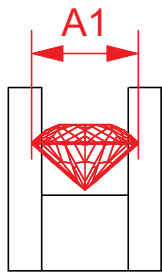
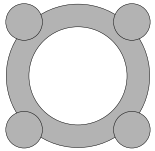

Diese Chatonserie ist aus einem Stück gegossen. Der Chaton besteht nicht aus Einzelteilen. Somit können Sie daran löten.



Guss-Chatons, 4 Stotzen, gerade Settings, casted, 4-prongs							
A1) Steinmaß in mm ca.		2,0	2,5	2,75	3,0	3,25	3,5
B) Steinauflage in mm		2,0	2,5	2,75	3,0	3,25	3,5
C) Stotzen-Ø in mm		0,9	0,95	1,0	1,0	1,0	1,05
D) Gesamthöhe in mm		4,5	4,9	5,5	5,8	6,2	6,7
E) Zargenhöhe in mm		2,6	2,6	2,6	2,6	2,6	2,9
Artikel-Nr.		564/2,0	564/2,5	564/2,75	564/3,0	564/3,25	564/3,5
935 Silber	1 St.	•	•	•	•	•	•
935 Silber	10 St.	•	•	•	•	•	•
585 GG	1 St.	•	•	•	•	•	•
585 RoseG	1 St.	•	•	•	•	•	•
585 RotG	1 St.	•	•	•	•	•	•
585 WG Pd	1 St.	•	•	•	•	•	•
750 GG	1 St.	•	•	•	•	•	•
750 RoseG	1 St.	•	•	•	•	•	•
750 RotG	1 St.	•	•	•	•	•	•
750 WG Pd	1 St.	•	•	•	•	•	•
950 Platin	1 St.	•	•	•	•	•	•

NEU Guss-Chatons, 4 Stotzen, gerade

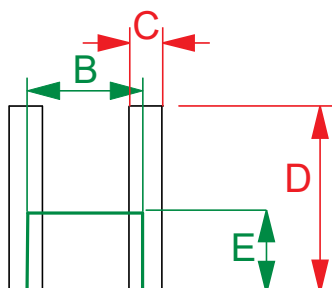
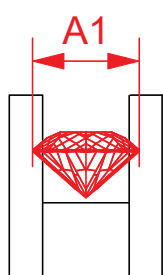
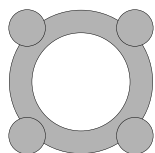

Diese Chatonserie ist aus einem Stück gegossen. Der Chaton besteht nicht aus Einzelteilen. Somit können Sie daran löten.



Guss-Chatons, 4 Stotzen, gerade Settings, casted, 4-prongs							
A1) Steinmaß in mm ca.		4,0	4,5	5,0	5,5	6,0	
B) Steinauflage in mm		4,0	4,5	5,0	5,5	6,0	
C) Stotzen-Ø in mm		1,15	1,2	1,2	1,25	1,25	
D) Gesamthöhe in mm		7,2	7,5	8,0	8,7	9,0	
E) Zargenhöhe in mm		3,0	3,1	3,4	3,6	3,8	
Artikel-Nr.		564/4,0	564/4,5	564/5,0	564/5,5	564/6,0	
935 Silber	1 St.	•	•	•	•	•	
935 Silber	10 St.	•	•	•	•	•	
585 GG	1 St.	•	•	•	•	•	
585 RoseG	1 St.	•	•	•	•	•	
585 RotG	1 St.	•	•	•	•	•	
585 WG Pd	1 St.	•	•	•	•	•	
750 GG	1 St.	•	•	•	•	•	
750 RoseG	1 St.	•	•	•	•	•	
750 RotG	1 St.	•	•	•	•	•	
750 WG Pd	1 St.	•	•	•	•	•	
950 Platin	1 St.	•	•	•	•	•	

NEU Guss-Chatons, 4 Stotzen, konisch

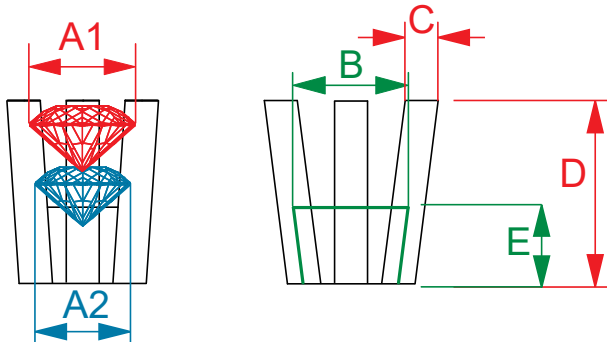
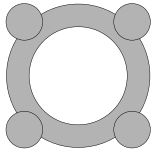

Diese Chatonserie ist aus einem Stück gegossen. Der Chaton besteht nicht aus Einzelteilen. Somit können Sie daran löten.



Guss-Chatons, 4 Stotzen, konisch Settings, casted, 4-prongs							
A1) Steinmaß in mm ca.		2,2	2,7	3,5	4,0	4,6	5,2
A2) Steinmaß in mm ca.		2,0	2,5	3,0	3,5	4,0	4,5
B) Steinauflage in mm		1,9	2,4	2,9	3,5	3,9	4,3
C) Stotzen-Ø in mm		0,9	0,95	1,0	1,1	1,15	1,20
D) Gesamthöhe in mm		4,5	4,8	5,3	5,9	6,2	7,0
E) Zargenhöhe in mm		2,5	2,5	2,5	2,8	2,9	3,1
Artikel-Nr.		550/2,0	550/2,5	550/3,0	550/3,5	550/4,0	550/4,5
935 Silber	1 St.	•	•	•	•	•	•
935 Silber	10 St.	•	•	•	•	•	•
585 GG	1 St.	•	•	•	•	•	•
585 RoseG	1 St.	•	•	•	•	•	•
585 RotG	1 St.	•	•	•	•	•	•
585 WG Pd	1 St.	•	•	•	•	•	•
750 GG	1 St.	•	•	•	•	•	•
750 RoseG	1 St.	•	•	•	•	•	•
750 RotG	1 St.	•	•	•	•	•	•
750 WG Pd	1 St.	•	•	•	•	•	•
950 Platin	1 St.	•	•	•	•	•	•

NEU Guss-Chatons, 4 Stotzen, konisch

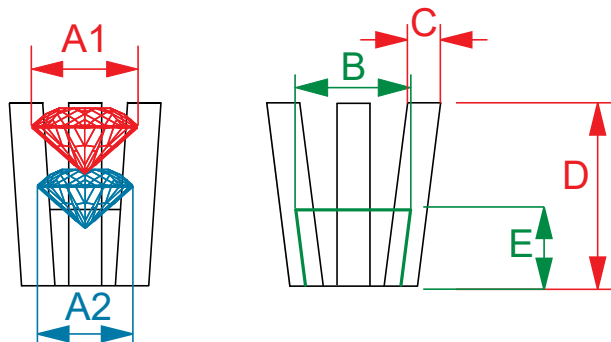
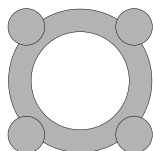

Diese Chatonserie ist aus einem Stück gegossen. Der Chaton besteht nicht aus Einzelteilen. Somit können Sie daran löten.



Guss-Chatons, 4 Stotzen, konisch Settings, casted, 4-prongs								
A1) Steinmaß in mm ca.		5,8	6,4	7,2	7,6	8,2	8,8	
A2) Steinmaß in mm ca.		5,0	5,5	6,0	6,5	7,0	7,5	8,0
B) Steinauflage in mm		4,9	5,2	5,9	6,3	6,9	7,3	
C) Stotzen-Ø in mm		1,20	1,25	1,25	1,30	1,30	1,30	
D) Gesamthöhe in mm		7,6	8,0	8,8	9,3	10,1	10,6	
E) Zargenhöhe in mm		3,4	3,6	3,7	3,8	4,1	4,3	
Artikel-Nr.		550/5,0	550/5,5	550/6,0	550/6,5	550/7,0	550/7,5	550/8,0
935 Silber	1 St.	•	•	•	•	•	•	•
935 Silber	10 St.	•	•	•	•	•	•	•
585 GG	1 St.	•	•	•	•	•	•	•
585 RoseG	1 St.	•	•	•	•	•	•	•
585 RotG	1 St.	•	•	•	•	•	•	•
585 WG Pd	1 St.	•	•	•	•	•	•	•
750 GG	1 St.	•	•	•	•	•	•	•
750 RoseG	1 St.	•	•	•	•	•	•	•
750 RotG	1 St.	•	•	•	•	•	•	•
750 WG Pd	1 St.	•	•	•	•	•	•	•
950 Platin	1 St.	•	•	•	•	•	•	•

NEU Guss-Chatons, 6 Stotzen, konisch

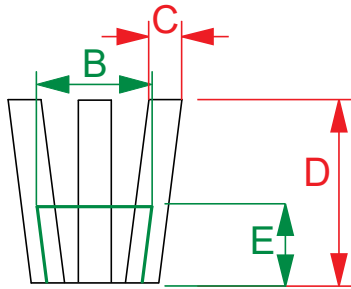
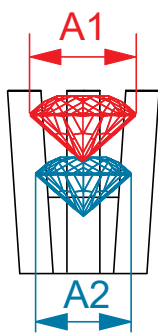
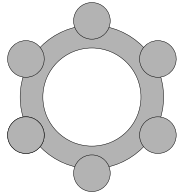

Diese Chatonserie ist aus einem Stück gegossen. Der Chaton besteht nicht aus Einzelteilen. Somit können Sie daran löten.



Guss-Chatons, 6 Stotzen, konisch Settings, casted, 6-prongs						
A1) Steinmaß in mm ca.	2,8	3,5	4,0	4,6	5,2	5,8
A2) Steinmaß in mm ca.	2,5	3,0	3,5	4,0	4,5	5,0
B) Steinauflage in mm	2,0	3,0	3,5	4,0	4,5	5,0
C) Stotzen-Ø in mm	0,80	0,95	1,0	1,0	1,0	1,05
D) Gesamthöhe in mm	4,6	5,4	6,0	6,4	7,1	7,7
E) Zargenhöhe in mm	2,5	2,5	2,8	3,0	3,1	3,4
Artikel-Nr.	549/2,5	549/3,0	549/3,5	549/4,0	549/4,5	549/5,0
935 Silber 1 St.	•	•	•	•	•	•
935 Silber 10 St.	•	•	•	•	•	•
585 GG 1 St.	•	•	•	•	•	•
585 RoseG 1 St.	•	•	•	•	•	•
585 RotG 1 St.	•	•	•	•	•	•
585 WG Pd 1 St.	•	•	•	•	•	•
750 GG 1 St.	•	•	•	•	•	•
750 RoseG 1 St.	•	•	•	•	•	•
750 RotG 1 St.	•	•	•	•	•	•
750 WG Pd 1 St.	•	•	•	•	•	•
950 Platin 1 St.	•	•	•	•	•	•

NEU Guss-Chatons, 6 Stotzen, konisch

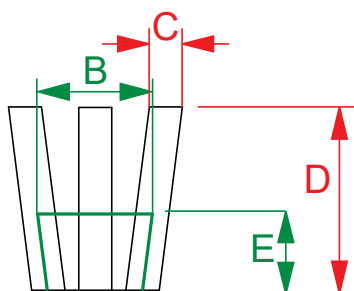
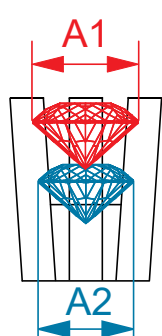
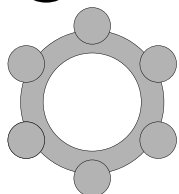

Diese Chatonserie ist aus einem Stück gegossen. Der Chaton besteht nicht aus Einzelteilen. Somit können Sie daran löten.



Guss-Chatons, 6 Stotzen, konisch Settings, casted, 6-prongs						
A1) Steinmaß in mm ca.	6,4	7,2	7,6	8,2	8,8	9,4
A2) Steinmaß in mm ca.	5,5	6,0	6,5	7,0	7,5	8,0
B) Steinauflage in mm	5,5	6,0	6,5	7,0	7,5	8,0
C) Stotzen-Ø in mm	1,05	1,1	1,1	1,15	1,15	1,2
D) Gesamthöhe in mm	8,1	8,9	9,3	10,2	10,7	11,2
E) Zargenhöhe in mm	3,6	3,8	4,0	4,2	4,4	4,6
Artikel-Nr.	549/5,5	549/6,0	549/6,5	549/7,0	549/7,5	549/8,0
935 Silber 1 St.	•	•	•	•	•	•
935 Silber 10 St.	•	•	•	•	•	•
585 GG 1 St.	•	•	•	•	•	•
585 RoseG 1 St.	•	•	•	•	•	•
585 RotG 1 St.	•	•	•	•	•	•
585 WG Pd 1 St.	•	•	•	•	•	•
750 GG 1 St.	•	•	•	•	•	•
750 RoseG 1 St.	•	•	•	•	•	•
750 RotG 1 St.	•	•	•	•	•	•
750 WG Pd 1 St.	•	•	•	•	•	•
950 Platin 1 St.	•	•	•	•	•	•

Zargen, rund, mit Stein- auflage Settings, round							
Stein-Ø in mm ca.	1,5	1,75	2,0	2,25	2,5	2,75	3,0
Außen-Ø in mm ca.	1,95	2,2	2,45	2,7	2,95	3,2	3,5
Höhe in mm ca.	2,0	2,0	2,5	2,5	2,5	2,5	3,0
Artikel-Nr.	284/1,5	284/1,75	284/2	284/2,25	284/2,5	284/2,75	284/3
935 Silber 1 St.	•	•	•	•	•	•	•
935 Silber 10 St.	•	•	•	•	•	•	•
585 GG 1 St.	•	•	•	•	•	•	•
585 RoseG 1 St.			•	•	•	•	•
585 RotG 1 St.		•	•	•	•	•	•
585 WG Pd 1 St.	•	•	•	•	•	•	•
750 GG 1 St.	•	•	•	•	•	•	•
750 RoseG 1 St.			•	•	•	•	•
750 RotG 1 St.			•	•	•	•	•
750 WG Pd 1 St.	•		•	•	•	•	•

Zargen, rund, mit Stein- auflage Settings, round						
Stein-Ø in mm ca.	3,25	3,5	3,75	4,0	4,25	4,5
Außen-Ø in mm ca.	3,75	4,0	4,25	4,55		5,05
Höhe in mm ca.	3,0	3,0	3,0	3,0		3,5
Artikel-Nr.	284/3,25	284/3,5	284/3,75	284/4	284/4,25	284/4,5
935 Silber 1 St.	•	•	•	•	•	•
935 Silber 10 St.	•	•	•	•	•	•
585 GG 1 St.	•	•	•	•	•	•
585 RotG 1 St.		•		•		•
585 WG Pd 1 St.		•		•		•
750 GG 1 St.	•	•		•		•
750 RoseG 1 St.		•		•		
750 RotG 1 St.		•		•		•
750 WG Pd 1 St.	•	•		•		•



SUMA FURNITUREN



Mulde 10 D-75239 Eisingen • ☎ +49 (0) 7232 809 454 • 📠 +49 (0) 7232 809 453 • ✉ info@sumafurnituren.de • www.sumafurnituren.de



Zargen, rund, mit Stein- auflage Settings, round						
Stein-Ø in mm ca.	5,0	5,5	6,0	6,5	7,0	7,5
Außen-Ø in mm ca.	5,55	6,05	6,6	7,1	7,6	8,1
Höhe in mm ca.	3,5	3,5	4,0	4,0	4,5	4,5
Artikel-Nr.	284/5	284/5,5	284/6	284/6,5	284/7	284/7,5
935 Silber 1 St.	•	•	•	•	•	•
935 Silber 10 St.	•	•	•	•	•	•
585 GG 1 St.	•	•	•	•	•	•
585 RotG 1 St.	•		•		•	
585 WG Pd 1 St.	•		•		•	
750 GG 1 St.	•	•	•	•	•	•
750 RotG 1 St.	•					
750 WG Pd 1 St.	•			•		

Zargen, rund, mit Stein- auflage Settings, round						
Stein-Ø in mm ca.	8,0	8,5	9,0	9,5	10,0	
Außen-Ø in mm ca.	8,6	9,15	9,65	10,15	10,75	
Höhe in mm ca.	4,5	4,5	4,5	4,5	5,0	
Artikel-Nr.	284/8	284/8,5	284/9	284/9,5	284/10	
935 Silber 1 St.	•	•	•	•	•	
935 Silber 10 St.	•	•	•	•	•	
585 GG 1 St.	•	•				

Bauchige Zargenfassungen

Zargen, rund, bauchig mit Steinauflage Settings, round						
Stein-Ø in mm ca.	2,0	2,5	3,0	3,5	4,0	4,5
Außen-Ø in mm ca.	3,8	4,4	5,05	5,75	6,45	7,15
Höhe in mm ca.	2,2	2,2	2,5	2,8	3,0	3,3
Artikel-Nr.	460/2,0	460/2,5	460/3	460/3,5	460/4	460/4,5
935 Silber 1 St.	•	•	•	•	•	•
935 Silber 10 St.	•	•	•	•	•	•
585 GG 1 St.	•	•	•	•	•	•
585 RoseG 1 St.	•					
585 RotG 1 St.	•	•	•	•	•	•
585 WG Pd 1 St.	•	•	•	•	•	•
750 GG 1 St.	•	•	•	•	•	•
750 RotG 1 St.	•	•	•	•	•	•
750 WG Pd 1 St.	•	•	•	•	•	•
950 Platin 1 St.				•	•	

Zargen, rund, bauchig mit Steinauflage Settings, round						
Stein-Ø in mm ca.	5,0	5,5	6,0	6,5	7,0	7,5
Außen-Ø in mm ca.	7,90	8,40	9,00	9,60	10,20	10,80
Höhe in mm ca.	3,5	3,5	4,0	4,0	4,3	4,5
Artikel-Nr.	460/5,0	460/5,5	460/6,0	460/6,5	460/7,0	460/7,5
935 Silber 1 St.	•	•	•	•	•	•
935 Silber 10 St.	•	•	•	•	•	•
585 GG 1 St.	•	•	•	•		
585 RotG 1 St.	•	•	•			
585 WG Pd 1 St.	•		•			
750 GG 1 St.	•	•	•	•		
750 WG Pd 1 St.	•					

Zargen, rund, bauchig mit Steinauflage Settings, round						
Stein-Ø in mm ca.	8,0	9,0	10,0	12,0	15,0	
Außen-Ø in mm ca.	11,45	12,75	14,05	16,80	19,70	
Höhe in mm ca.	4,7	5,2	5,5	6,5	8,5	
Artikel-Nr.	460/8,0	460/9,0	460/10,0	460/12,0	460/15,0	
935 Silber 1 St.	•	•	•	•	•	

Zargen in weiteren Größen und Goldlegierungen auf Anfrage!

Quadratische Zargenfassungen

Zargen, quadratisch, mit Steinauflage Settings, quadratical						
Steinmaß in mm ca.	2,0 x 2,0	2,5 x 2,5	3,0 x 3,0	3,5 x 3,5	4,0 x 4,0	4,5 x 4,5
Höhe in mm ca.	2,5	2,5	2,5	3,0	3,5	3,5
Artikel-Nr.	461/2,0	461/2,5	461/3	461/3,5	461/4,0	461/4,5
935 Silber 1 St.	•	•	•	•	•	•
935 Silber 10 St.	•	•	•	•	•	•
585 GG 1 St.	•	•	•	•	•	•
585 RotG 1 St.					•	
585 WG Pd 1 St.	•	•			•	•
750 GG 1 St.	•	•	•	•	•	•
750 WG 1 St.	•					



Zargen, quadratisch, mit Steinauflage Settings, quadratical						
Steinmaß in mm ca.	5,0 x 5,0	5,5 x 5,5	6,0 x 6,0	6,5 x 6,5	7,0 x 7,0	8,0 x 8,0
Höhe in mm ca.	3,5	3,5	4,0	4,0	4,5	4,5
Artikel-Nr.	461/5,0	461/5,5	461/6,0	461/6,5	461/7,0	461/8,0
935 Silber 1 St.	•	•	•	•	•	•
935 Silber 10 St.	•	•	•	•	•	•
585 GG 1 St.	•		•			
585 RotG 1 St.	•					
750 GG 1 St.	•		•			
750 WG 1 St.	•					

Ovale Zargenfassungen



Zargen, oval, mit Steinauflage Settings, oval						
Steinmaß in mm ca.	5 x 3	6 x 4	7 x 5	8 x 6	9 x 7	10 x 8
Höhe in mm ca.	2,5	3,0	3,0	3,5	3,5	3,5
Artikel-Nr.	462/5	462/6	462/7	462/8	462/9	462/10
935 Silber 1 St.	•	•	•	•	•	•
935 Silber 10 St.	•	•	•	•	•	•
585 GG 1 St.	•	•	•	•	•	•
585 WG 1 St.	•	•				
750 GG 1 St.	•	•	•	•	•	•

Zargen in weiteren Größen und Goldlegierungen auf Anfrage!



Zargenfassungen, navette

Zargen, navette, mit Steinauflage Settings, navette					
Steinmaß in mm ca.	4 x 2	5 x 2,5	6 x 3	7 x 4	8 x 4
Höhe in mm ca.	2,5	3,0	3,0	3,5	3,5
Artikel-Nr.	463/4	463/5	463/6	463/7	463/8
935 Silber 1 St.	•	•	•	•	•
935 Silber 10 St.	•	•	•	•	•
585 GG 1 St.	•	•	•	•	•
585 WG Pd 1 St.	•				•
750 GG 1 St.	•	•	•	•	•
750 WG 1 St.					•

Zargenfassungen, Tropfenform

Zargen, Tropfenform, mit Steinauflage Settings, pearshape					
Steinmaß in mm ca.	5 x 3	6 x 4	7 x 5	10 x 7	12 x 8
Höhe in mm ca.	2,5	3,0	3,5	3,5	4,5
Artikel-Nr.	464/5	464/6	464/7	464/10	464/12
935 Silber 1 St.	•	•	•	•	•
935 Silber 10 St.	•	•	•	•	•
585 GG 1 St.	•	•	•	•	•
750 GG 1 St.	•	•	•	•	•







Zargenfassungen, Herz





Zargen, Herzform, mit Steinauflage Settings, heart					
Steinmaß in mm ca.	4 x 4	5 x 5	6 x 6	7 x 7	8 x 8
Höhe in mm ca.	2,5	3,0	3,5	4,0	4,5
Artikel-Nr.	465/4	465/5	465/6	465/7	465/8
935 Silber 1 St.	•	•	•	•	•
585 GG 1 St.	•	•	•		
750 GG 1 St.		•	•	•	







Zargen in weiteren Größen und Goldlegierungen auf Anfrage!





SUMA FURNITUREN







Mulde 10 D-75239 Eisingen • ☎ +49 (0) 7232 809 454 • 📠 +49 (0) 7232 809 453 • ✉ info@sumafurnituren.de • www.sumafurnituren.de







Steinfassungen, rund, gezackter Rand, mit Boden Settings, round with serrated cutting edges and bottom						
Innen-Ø mm ca.	5,0	5,5	6,0	6,5	7,0	8,0
Außen-Ø x Höhe mm ca.	5,6 x 2,1	6,1 x 2,1	6,8 x 2,4	7,3 x 2,2	8,0 x 2,7	9,0 x 3,2
Artikel-Nr.	201A/5	201A/5,5	201A/6	201A/6,5	201A/7	201A/8
935 Silber 1 St.	•	•	•	•	•	•
935 Silber 10 St.	•	•	•	•	•	•







Steinfassungen, rund, gezackter Rand, mit Boden Settings, round with serrated cutting edges and bottom						
Innen-Ø mm ca.	8,5	10,0	10,5	12,0	13,0	
Außen-Ø x Höhe mm ca.	9,1 x 3,2	11,0 x 2,8	11,5 x 3,2	13,0 x 2,7	14,0 x 2,5	
Artikel-Nr.	201A/8,5	201A/10	201A/10,5	201A/12	201A/13	
935 Silber 1 St.	•	•	•	•	•	
935 Silber 10 St.	•	•	•	•	•	





Steinfassungen, rund, gezackter Rand, ohne Boden Settings, round with serrated cutting edges, without bottom						
Innen-Ø mm ca.	5,0	5,5	6,0	6,5	7,0	8,0
Außen-Ø x Höhe mm ca.	5,6 x 2,1	6,1 x 2,1	6,8 x 2,4	7,3 x 2,2	8,0 x 2,7	9,0 x 3,2
Artikel-Nr.	202A/5	202A/5,5	202A/6	202A/6,5	202A/7	202A/8
935 Silber 1 St.	•	•	•	•	•	•
935 Silber 10 St.	•	•	•	•	•	•

Steinfassungen, rund, gezackter Rand, ohne Boden Settings, round with serrated cutting edges, without bottom						
Innen-Ø mm ca.	8,5	10,0	10,5	12,0	13,0	
Außen-Ø x Höhe mm ca.	9,1 x 3,2	11,0 x 2,8	11,5 x 3,2	13,0 x 2,7	13,6 x 2,5	
Artikel-Nr.	202A/8,5	202A/10	202A/10,5	202A/12	202A/13	
935 Silber 1 St.	•	•	•	•	•	
935 Silber 10 St.	•	•	•	•	•	

Steinfassungen, rund Settings, round						
Innen-Ø mm ca.	1,8	2,0	2,25	2,5	2,8	3,1
Außen-Ø x Höhe mm ca.	2,2 x 1,2	2,4 x 1,3	2,65 x 1,4	2,9 x 1,5	3,2 x 1,6	3,5 x 1,8
Artikel-Nr.	203A/1,8	203A/2	203A/2,25	203A/2,5	203A/2,8	203A/3,1
935 Silber 1 St.	•	•	•	•	•	•
935 Silber 10 St.	•	•	•	•	•	•
585 GG 1 St.						•
750 GG 1 St.						•

Steinfassungen, rund Settings, round						
Innen-Ø mm ca.	3,8	4,25	4,8	5,5	6,3	7,1
Außen-Ø x Höhe mm ca.	4,2 x 1,9	4,65 x 2,0	5,2 x 2,25	5,95 x 2,2	6,7 x 1,8	7,5 x 2,0
Artikel-Nr.	203A/3,8	203A/4,25	203A/4,8	203A/5,5	203A/6,3	203A/7,1
935 Silber 1 St.	•	•	•	•	•	•
935 Silber 10 St.	•	•	•	•	•	•
585 GG 1 St.	•	•	•	•	•	•
750 GG 1 St.	•	•	•	•	•	•





Steinfassungen, rund Settings, round						
Innen-Ø mm ca.	7,5	8,2	8,7	9,1	9,5	10,0
Außen-Ø x Höhe mm ca.	8,0 x 1,6	8,6 x 1,7	9,2 x 1,8	9,6 x 2,5	9,9 x 3,5	10,6 x 1,8
Artikel-Nr.	203A/7,5	203A/8,2	203A/8,7	203A/9,1	203A/9,5	203A/10
935 Silber 1 St.	•	•	•	•	•	•
935 Silber 10 St.	•	•	•	•	•	•
585 GG 1 St.	•	•		•	•	•
750 GG 1 St.	•	•				•





Steinfassungen, rund Settings, round						
Innen-Ø mm ca.	10,5	11,0	12,0	13,1	15,0	
Außen-Ø x Höhe mm ca.	10,9 x 1,9	11,5 x 2,1	12,4 x 2,3	13,5 x 1,6	15,4 x 3,4	
Artikel-Nr.	203A/10,5	203A/11	203A/12	203A/13	203A/15	
935 Silber 1 St.	•	•	•	•	•	
935 Silber 10 St.	•	•	•	•	•	
585 GG 1 St.	•	•	•	•	•	
750 GG 1 St.	•	•	•			

Fassungen in Goldlegierungen auf Anfrage!

SUMA FURNITUREN

Mulde 10 D-75239 Eisingen • ☎ +49 (0) 7232 809 454 • 📠 +49 (0) 7232 809 453 • ✉ info@sumafurnituren.de • www.sumafurnituren.de

Steinfassungen, oval Settings, oval					
Innenmaße mm ca.	8,0 x 6,0	10,1 x 8,2	12,0 x 10,0	14,0 x 10,0	16,0 x 12,0
Höhe in mm ca.	1,2	1,4	1,5	1,5	1,4
Artikel-Nr.	204A/8	204A/10	204A/12	204A/14	204A/16
935 Silber 1 St.	•	•	•	•	•
935 Silber 10 St.	•	•	•	•	•
585 GG 1 St.	•	•	•		

Steinfassungen, oval Settings, oval					
Innenmaße mm ca.	17,8 x 13,0	18,5 x 10,0	20,0 x 15,0	25,5 x 18,5	30,0 x 21,7
Höhe in mm ca.	1,6	2,7	1,6	1,7	1,8
Artikel-Nr.	204A/17	204A/18	204A/20	204A/25	204A/30
935 Silber 1 St.	•	•	•	•	•
935 Silber 10 St.	•	•	•	•	•

Steinfassungen, lang-oval Settings, long-oval					
Innenmaße mm ca.	31,2 x 13,7				
Höhe in mm ca.	2,1				
Artikel-Nr.	204A/31				
935 Silber 1 St.	•				
935 Silber 10 St.	•				

Runde Steinfassungen mit einer oder zwei Ösen
Round settings for stones with one or two rings

Runde Steinfassungen mit Öse und Anhängerschleufe
Round settings for stones with ring and bail



203B/7,1



203C/7,1



203D/...
 mit einer geschlossenen
 Öse und Einhängerschleufe
 120G



203E/...
 mit einer geschlossenen
 Öse und Anhängerschleufe
 120KG



203F/...
 mit einer geschlossenen
 Öse und Anhängerschleufe
 120/5

Artikel-Nr.		203B/ ...		203C/ ...		203D/ ...		203E/ ... mit 120 KG 203F/ ... mit 120/5	
= Innen-Ø in mm ca.	Außen-Ø x Höhe in mm ca.	mit einer geschlossenen Öse		mit zwei geschlossenen Ösen		mit einer geschlossenen Öse und Einhängerschleufe 120 G		mit einer geschlossenen Öse und verlöteter Anhängerschleufe	
		935 Silber		935 Silber		935 Silber		935 Silber	
		1 St.	10 St.	1 St.	10 St.	1 St.	10 St.	1 St.	10 St.
6,3	6,7 x 1,8	•	•	•	•	•	•		
7,1	7,5 x 2,0	•	•	•	•	•	•		
7,5	8,0 x 1,6	•	•	•	•	•	•	•	•
8,2	8,6 x 1,7	•	•	•	•	•	•	•	•
8,7	9,2 x 1,8	•	•	•	•	•	•	•	•
9,1	9,6 x 2,5	•	•	•	•	•	•	•	•
9,5	9,9 x 3,5	•	•	•	•	•	•	•	•
10,0	10,6 x 1,8	•	•	•	•	•	•	•	•
10,5	10,9 x 1,9	•	•	•	•	•	•	•	•
11,0	11,5 x 2,1	•	•	•	•	•	•	•	•
12,0	12,4 x 2,3	•	•	•	•	•	•	•	•
13,1	17,4 x 1,6	•	•	•	•	•	•	•	•
15,0	15,4 x 3,4	•	•	•	•	•	•	•	•

SUMA FURNITUREN

Mulde 10 D-75239 Eisingen • ☎ +49 (0) 7232 809 454 • 📠 +49 (0) 7232 809 453 • ✉ info@sumafurnituren.de • www.sumafurnituren.de

Ovale Fassungen mit einer oder zwei Ösen Oval settings with one or two rings



204B/17
oval



204C/31
lang-oval



204D/...
mit einer geschlossenen
Öse und Einhängeschlaufe
120G



204E/...
mit einer geschlossenen
Öse und Anhängeschlaufe
120KG



204F/...
mit einer geschlossenen
Öse und Anhängeschlaufe
120/5

Artikel-Nr.		204B/ ...		204C/ ...		204D/ ...		204E/ ... mit 120KG 204F/ ... mit 120/5	
	Innenmaße / Höhe in mm ca.	mit einer geschlossenen Öse		mit 2 geschlossenen Ösen		mit einer geschlossenen Öse und Einhängeschlaufe 120G		mit einer geschlossenen Öse und verlöteter Anhängeschlaufe	
		935 Silber		935 Silber		935 Silber		935 Silber	
		1 St.	10 St.	1 St.	10 St.	1 St.	10 St.	1 St.	10 St.
OVAL									
8	8,0 x 6,0 / 1,2	•	•	•	•	•	•	•	•
10	10,1 x 8,2 / 1,4	•	•	•	•	•	•	•	•
12	12,0 x 10,0 / 1,5	•	•	•	•	•	•	•	•
14	14,0 x 10,0 / 1,5	•	•	•	•	•	•	•	•
16	16,0 x 12,0 / 1,4	•	•	•	•	•	•	•	•
17	17,8 x 13,0 / 1,6	•	•	•	•	•	•	•	•
18	18,5 x 10,0 / 2,7	•	•	•	•	•	•	•	•
20	20,0 x 15,0 / 1,6	•	•	•	•	•	•	•	•
25	25,6 x 18,5 / 1,7	•	•	•	•	•	•	•	•
30	30,1 x 21,7 / 1,8	•	•	•	•	•	•	•	•
31	31,2 x 13,7 / 2,1	•	•	•	•	•	•	•	•

Münzfassungen mit glattem Rand
Münzfassungen mit glattem Rand und Schlaufe

Coin mountings with plain edge
Coin mountings with plain edge and bail



Artikel-Nr.
309 + [Buchstabe]



Artikel-Nr.
3091 + [Buchstabe]

Seitenansicht
Schlaufe 120G
(zum Einhängen)

Artikel-Nr.	Innen- Ø in mm ca.	Innen- höhe in mm ca.	Außen- höhe in mm ca.	309 ...						3091 ...		
				935 Silber		585 GG	750 GG	935 Silber		585 GG		
				1 St.	10 St.	1 St.	1 St.	1 St.	10 St.	1 St.		
A	13,2	1,0	1,4	•	•	•	•	•	•	•		
B	15,7	0,85	1,4	•	•	•	•	•	•	•		
T	16,2	1,05	1,9	•	•	•	•	•	•	•		
C	16,6	1,1	1,9	•	•	•	•	•	•	•		
D	17,2	0,8	1,4	•	•	•	•	•	•	•		
E	20,2	0,95	1,8	•	•	•	•	•	•	•		
F	21,4	1,05	1,9	•	•	•	•	•	•	•		
G	22,5	1,7	2,6	•	•	•	•	•	•	•		
H	22,7	1,5	2,2	•	•	•	•	•	•	•		
K	24,0	2,2	3,3	•	•	•	•	•	•	•		
J	25,3	1,7	2,6	•	•	•	•	•	•	•		
L	26,2	1,1	1,7	•	•	•	•	•	•	•		
Q	26,2	2,0	2,4	•	•	•	•	•	•	•		
U	28,3	1,9	2,9	•	•	•	•	•	•	•		
M	29,2	1,9	2,4	•	•	•	•	•	•	•		
N	31,1	1,6	2,7	•	•	•	•	•	•	•		
V	31,4	2,05	2,5	•	•	•	•	•	•	•		
W	32,7	1,4	2,7	•	•	•	•	•	•	•		
O	33,1	1,6	2,5	•	•	•	•	•	•	•		
X	34,5	2,3	3,5	•	•	•	•	•	•	•		
Z	35,4	1,6	2,8	•	•	•	•	•	•	•		
Y	36,3	2,3	3,6	•	•	•	•	•	•	•		
P	38,3	2,4	3,5	•	•	•	•	•	•	•		
R	40,1	1,6	2,5	•	•	•	•	•	•	•		
S	41,3	2,05	3,1	•	•	•	•	•	•	•		

Artikel-Nr.	Ø mm ca.	passend für:
309A	13,2	2 mex. Peso
309B	15,7	2 1/2 Peso
309C	16,6	1 Pfennig, 1 Euro-Cent
309D	17,2	Goldmark
309E	20,2	10 Goldmark
309F	21,4	Vreneli
309H	22,7	20 Goldmark
309K	24,0	1 DM, 1 Euro
309L	26,2	Gedenkmünze

309Q	26,2	2 Euro
309U	28,3	1 holl. Gulden
309M	29,2	2 RM
309N	31,1	Kennedy
309W	32,7	10 Euro
309O	33,1	3 RM
309P	38,3	5 RM
309R	40,1	4 öst. Dukaten
309S	41,3	Maria-Theresien-Taler

SUMA FURNITUREN

Mulde 10 D-75239 Eisingen • ☎ +49 (0) 7232 809 454 • 📠 +49 (0) 7232 809 453 • ✉ info@sumafurnituren.de • www.sumafurnituren.de

Münzfassungen mit glattem Rand und Schlaufe Coin mountings with plain edge and bail

Münzfassungen mit Kordelrand und Schlaufe Coin mountings with twisted edge and bail



Beide Münzfassungs-Serien haben eine geschlossene Öse und die Anhängerschlaufen sind geschlossen und verlötet. Die Seitenansichten der Schlaufen sind in Originalgröße abgebildet.



Artikel-Nr.	Innen- Ø in mm ca.	Innen- höhe in mm ca.	Außen- höhe in mm ca.	3095 ...			3085 ...		
				935 Silber		585 GG	935 Silber		585 GG
				1 St.	10 St.	1 St.	1 St.	10 St.	1 St.
A	13,2	1,0	1,4	•	•	•	•	•	auf Anfrage
B	15,7	0,85	1,4	•	•	•	•	•	
T	16,2	1,05	1,9	•	•	•	•	•	
C	16,6	1,1	1,9	•	•	•	•	•	
D	17,2	0,8	1,4	•	•	•	•	•	
E	20,2	0,95	1,8	•	•	•	•	•	•
F	21,4	1,05	1,9	•	•	•	•	•	
G	22,5	1,7	2,6	•	•	•	•	•	•
H	22,7	1,5	2,2	•	•	•	•	•	*** auf Anfrage ***
K	24,0	2,2	3,3	•	•	•	•	•	
J	25,3	1,7	2,6	•	•	•	•	•	
L	26,2	1,1	1,7	•	•	•	•	•	
Q	26,2	2,0	2,4	•	•	•	•	•	
U	28,3	1,9	2,9	•	•	•	•	•	
M	29,2	1,9	2,4	•	•	•	•	•	
N	31,1	1,6	2,7	•	•	•	•	•	
V	31,4	2,05	2,5	•	•	•	•	•	
W	32,7	1,4	2,7	•	•	•	•	•	
O	33,1	1,6	2,5	•	•	•	•	•	
X	34,5	2,3	3,5	•	•	•	•	•	
Y	36,3	2,3	3,6	•	•	•	•	•	
P	38,3	2,4	3,5	•	•	•	•	•	
R	40,1	1,6	2,5	•	•	•	•	•	
S	41,3	2,05	3,1	•	•	•	•	•	

Buchstaben Serie 206 - ohne Öse



A B

Höhe der Buchstaben: ca. 9 mm
Materialstärke: ca. 0,8 mm

Buchstaben Letters	A	B	C	D	E	F	G
Artikel-Nr.	206A	206B	206C	206D	206E	206F	206G
935 Silber 1 St.	•	•	•	•	•	•	•
935 Silber 10 St.	•	•	•	•	•	•	•
585 GG 1 St.	•	•	•	•	•	•	•

Buchstaben Letters	H	I	J	K	L	M	N
Artikel-Nr.	206H	206I	206J	206K	206L	206M	206N
935 Silber 1 St.	•	•	•	•	•	•	•
935 Silber 10 St.	•	•	•	•	•	•	•
585 GG 1 St.	•	•	•	•	•	•	•

Buchstaben Letters	O	P	Q	R	S	T	U
Artikel-Nr.	206O	206P	206Q	206R	206S	206T	206U
935 Silber 1 St.	•	•	•	•	•	•	•
935 Silber 10 St.	•	•	•	•	•	•	•
585 GG 1 St.	•	•	•	•	•	•	•

Buchstaben Letters	V	W	X	Y	Z
Artikel-Nr. ohne Öse	206V	206W	206X	206Y	206Z
935 Silber 1 St.	•	•	•	•	•
935 Silber 10 St.	•	•	•	•	•
585 GG 1 St.	•	•	•	•	•

SUMA FURNITUREN

Mulde 10 D-75239 Eisingen • ☎ +49 (0) 7232 809 454 • 📠 +49 (0) 7232 809 453 • ✉ info@sumafurnituren.de • www.sumafurnituren.de

Buchstaben Serie 207 - mit Öse



Höhe der Buchstaben: ca. 9 mm (ohne Öse)
Materialstärke: ca. 0,8 mm

Buchstaben Letters	A	B	C	D	E	F	G
Artikel-Nr.	207A	207B	207C	207D	207E	207F	207G
935 Silber 1 St.	•	•	•	•	•	•	•
935 Silber 10 St.	•	•	•	•	•	•	•
585 GG 1 St.	•	•	•	•	•	•	•

Buchstaben Letters	H	I	J	K	L	M	N
Artikel-Nr.	207H	207I	207J	207K	207L	207M	207N
935 Silber 1 St.	•	•	•	•	•	•	•
935 Silber 10 St.	•	•	•	•	•	•	•
585 GG 1 St.	•	•	•	•	•	•	•

Buchstaben Letters	O	P	Q	R	S	T	U
Artikel-Nr.	207O	207P	207Q	207R	207S	207T	207U
935 Silber 1 St.	3,10	3,10	3,10	3,10	3,10	3,10	3,10
935 Silber 10 St.	29,00	29,00	29,00	29,00	29,00	29,00	29,00
585 GG 1 St.	55,50	60,50	55,50	61,20	51,20	49,10	60,50







Buchstaben Letters	V	W	X	Y	Z
Artikel-Nr.	207V	207W	207X	207Y	207Z
935 Silber 1 St.	•	•	•	•	•
935 Silber 10 St.	•	•	•	•	•
585 GG 1 St.	•	•	•	•	•







Silber-Kugeln 925/- schwere Standardausführung 2-Loch-Kugel, glatt, rund







Silver beads 925/- heavy, strong standard version 2-hole-beads, smooth, round



Kugeln Silber-vergoldet
unsere Kugeln sind alle mit einer 5 Milli-
m starken Goldschicht plattiert!

						
Kugel-Ø in mm ca.	1,8	2,0	2,5	2,5	3,0	3,0
Bohrung-Ø in mm ca.	0,8	0,9	0,9	1,2	0,9	1,2
Artikel-Nr.	30018	30020	30025	30025/1,2	30030	30030/1,2
925 Silber 10 St.	•	•	•	•	•	•
925 Silber 100 St.	•	•	•	•	•	•
925 Silber 1000 St.	•	•	•	•	•	•
925 Silber GGP 05 10 St.	•	•	•	•	•	•
925 Silber GGP 05 100 St.	•	•	•	•	•	•
925 Silber GGP 05 1000 St.	•	•	•	•	•	•

						
Kugel-Ø in mm ca.	3,0	3,5	4,0	4,0	4,0	5,0
Bohrung-Ø in mm ca.	1,5	1,6	1,0	1,5	1,8	1,5
Artikel-Nr.	30030/1,5	30035	30040	30040/1,5	30040/1,8	30050
925 Silber 10 St.	•	•	•	•	•	•
925 Silber 100 St.	•	•	•	•	•	•
925 Silber 500 St.	•	•	•	•	•	•
925 Silber 1000 St.	•	•	•	•	•	•
925 Silber GGP 05 10 St.	•	•	•	•	•	•
925 Silber GGP 05 100 St.	•	•	•	•	•	•
925 Silber GGP 05 500 St.	•	•	•	•	•	•
925 Silber GGP 05 1000 St.	•	•	•	•	•	•







						
Kugel-Ø in mm ca.	5,0	6,0	7,0	8,0	9,0	10,0
Bohrung-Ø in mm ca.	2,2	1,8	1,8	1,6	1,7	1,5
Artikel-Nr.	30050/2,2	30060	30070	30080	30090	30100
925 Silber 1 St.	•	•	•	•	•	•
925 Silber 10 St.	•	•	•	•	•	•
925 Silber 100 St.	•	•	•	•	•	•
925 Silber GGP 05 1 St.	•	•	•	•	•	•
925 Silber GGP 05 10 St.	•	•	•	•	•	•
925 Silber GGP 05 100 St.	•	•	•	•	•	•





SUMA FURNITUREN

Mulde 10 D-75239 Eisingen • ☎ +49 (0) 7232 809 454 • 📠 +49 (0) 7232 809 453 • ✉ info@sumafurnituren.de • www.sumafurnituren.de

Silber-Kugeln 925/-
schwere Standardausführung
 2-Loch-Kugel, glatt, rund,
mit großer Bohrung

Silver beads 925/-
heavy, strong standard version
 2-hole-beads, smooth, round, strong
 standard version, *with large hole*





						
Kugel-Ø in mm ca.	6,0	7,0	8,0	8,0	9,0	10,0
Bohrung-Ø in mm ca.	2,4	2,7	2,0	3,0	3,6	2,2
Artikel-Nr.	3306	3307	3308	3308/3,0	3309	3310
925 Silber 1 St.	•	•	•	•	•	•
925 Silber 10 St.	•	•	•	•	•	•
925 Silber 100 St.	•	•	•	•		
925 Silber GGP 05 1 St.	•	•	•	•	•	•
925 Silber GGP 05 10 St.	•	•	•	•	•	•
925 Silber GGP 05 100 St.	•	•				



						
Kugel-Ø in mm ca.	10,0	11,0	11,0	12,0		
Bohrung-Ø in mm ca.	3,4	2,7	3,9	2,7		
Artikel-Nr.	3310/3,4	3311/2,7	3311	3312		
925 Silber 1 St.	•	•	•	•		
925 Silber 10 St.	•	•	•	•		

Silber-Kugeln 925/-
gelötete Ausführung, leichte Kugel
für Ohrschmuck geeignet
 2-Loch-Kugel, glatt, rund

Silver beads 925/-
soldered version, light bead
for earring jewellery
 2-hole-beads, smooth, round



gelötete Ausführung soldered quality					
Kugel-Ø in mm ca.	12,0	14,0	16,0	18,0	20,0
Bohrung-Ø in mm ca.	1,5	1,5	1,5	1,5	1,5
Artikel-Nr.	30120	30140	30160	30180	30200
925 Silber 1 St.	•	•	•	•	•
925 Silber 10 St.	•	•	•	•	•

gelötete Ausführung soldered quality				
Kugel-Ø in mm ca.	23,0	29,0		
Bohrung-Ø in mm ca.	1,5	1,5		
Artikel-Nr.	30230	30290		
925 Silber 1 St.	•	•		
925 Silber 10 St.	•			

SUMA FURNITUREN

Mulde 10 D-75239 Eisingen • ☎ +49 (0) 7232 809 454 • 📠 +49 (0) 7232 809 453 • ✉ info@sumafurnituren.de • www.sumafurnituren.de

Gold-Kugeln 585/- 750/-
schwere Standardausführung
 2-Loch-Kugel, glatt, rund

Gold beads 585/- 750/-
heavy, strong standard version
 2-hole-beads, smooth, round



Kugel-Ø in mm ca.		2,0	2,5	3,0	3,5	4,0	5,0	6,0
Bohrung-Ø in mm ca.		0,9	1,2	1,2	1,5	1,5	1,5	1,3
Artikel-Nr.		310/2	310/2,5	310/3	310/3,5	310/4	310/5	310/6
585 GG	1 St.	•	•	•		•	•	•
585 GG	10 St.	•	•	•		•	•	•
585 RotG	1 St.	•		•		•	•	•
585 RotG	10 St.	•		•		•	•	
585 WG	1 St.	•		•		•	•	•
585 WG	10 St.	•		•		•	•	•
750 GG	1 St.	•	•	•	•	•	•	•
750 GG	10 St.	•	•	•	•	•	•	•
750 RotG	1 St.	•	•	•		•	•	•
750 RotG	10 St.	•	•	•		•	•	
750 WG	1 St.	•		•		•	•	•
750 WG	10 St.	•		•		•	•	

Kugel-Ø in mm ca.		7,0	8,0	10,0	12,0		
Bohrung-Ø in mm ca.		1,5	1,5	1,5	1,5		
Artikel-Nr.		310/7	310/8	310/10	310/12		
585 GG	1 St.	•	•	•	•		
585 RotG	1 St.		•				
585 WG	1 St.	•	•	•			
750 GG	1 St.	•	•	•	•		
750 RotG	1 St.	•	•	•			
750 WG	1 St.		•	•			

Gold-Kugeln 585/- 750/-

leichte Ausführung







2-Loch-Kugel, glatt, rund, nur für Auffädelarbeiten empfohlen



Gold beads 585/- 750/-

light version

2-hole-beads, smooth, round, recommended only for beading



						
Kugel-Ø in mm ca.	2,0	2,5	3,0	4,0	5,0	6,0
Bohrung-Ø in mm ca.	0,8	1,0	0,9	1,5	1,3	1,8
Artikel-Nr.	30020	30025	30030	30040	30050	30060
585 GG 1 St.	•	•	•	•	•	•
585 GG 10 St.	•	•	•	•		
750 GG 1 St.	•	•	•	•	•	•
750 GG 10 St.	•	•	•	•		

						
Kugel-Ø in mm ca.	7,0	8,0	9,0			
Bohrung-Ø in mm ca.	1,7	1,6	1,5			
Artikel-Nr.	30070	30080	30090			
585 GG 1 St.	•	•	•			

2-Loch-Kugeln Sterneffekt

schwere Standardausführung

2-Loch-Kugeln, rund



2-hole-beads, star dust

heavy, strong standard version

2-hole-beads, round



Silber GGP 05 = plattierte
Goldauflage mit 5 Milliem Stärke



2-Loch-Kugeln, Sterneffekt 2-hole beads, star dust						
Kugel-Ø in mm ca.	3,0	3,0	3,0	4,0	5,0	6,0
Bohrung-Ø in mm ca.	0,9	1,2	1,5	1,5	2,1	1,8
Artikel-Nr.	3203	3203/1,2	3203/1,5	3204	3205	3206
925 Silber 1 St.	•	•	•	•	•	•
925 Silber 10 St.	•	•	•	•	•	•
925 Silber 100 St.	•	•	•	•	•	•
925 Silber GGP 05 1 St.	•	•	•	•	•	•
925 Silber GGP 05 10 St.	•	•	•	•	•	•
925 Silber GGP 05 100 St.	•	•	•	•	•	•
585 GG 1 St.				•		
750 GG 1 St.	•		•			

Kugel-Ø in mm ca.	7,0	8,0	14,0	16,0		
Bohrung-Ø in mm ca.	1,8	2,0	1,6	1,6		
Artikel-Nr.	3207	3208	3214	3216		
925 Silber 1 St.	•	•	•	•		
925 Silber 10 St.	•	•				
925 Silber GGP 05 1 St.	•	•	•	•		
925 Silber GGP 05 10 St.	•	•				

Silber-Kugeln 925/- schwere Standardausführung 2-Loch-Kugel, mattiert, rund







Silver beads 925/- heavy, strong standard version 2-hole-beads, velvet, round

2-Loch-Kugeln matt 2-hole-beads, velvet						
Maße / Ø in mm ca.	4	5	6			
Artikel-Nr.	32440	32450	32460			
925 Silber 1 St.	•	•	•			
925 Silber 10 St.	•	•	•			
925 Silber 100 St.	•	•	•			
925 Silber GGP 05 1 St.	•	•	•			
925 Silber GGP 05 10 St.	•	•	•			
925 Silber GGP 05 100 St.	•	•	•			

Silber-Kugeln 925/- schwere Standardausführung 2-Loch-Kugel, gerieft, rund



Silver beads 925/- heavy, strong standard version 2-hole-beads, corrugated, round

						
Kugel-Ø in mm ca.	3,0	4,0	5,0	6,0		
Bohrung-Ø in mm ca.	1,5	1,8	2,2	1,8		
Artikel-Nr.	31030	31040	31050	31060		
925 Silber 1 St.	•	•	•	•		
925 Silber 10 St.	•	•	•	•		
925 Silber 100 St.	•	•	•	•		
925 Silber GGP 05 1 St.	•	•	•	•		
925 Silber GGP 05 10 St.	•	•	•	•		
925 Silber GGP 05 100 St.	•	•	•	•		

SUMA FURNITUREN

Mulde 10 D-75239 Eisingen • ☎ +49 (0) 7232 809 454 • 📠 +49 (0) 7232 809 453 • ✉ info@sumafurnituren.de • www.sumafurnituren.de

2-Loch-Kugeln, Disko

schwere Standardausführung





Disko, rund



2-hole-beads, disco

heavy, strong standard version

disco, round

					
Kugel-Ø in mm ca.	3,0	4,0	5,0	6,0	8,0
Bohrung-Ø in mm ca.	1,2	1,5	1,5	1,8	2,0
Artikel-Nr.	7403	7404	7405	7406	7408
925 Silber 1 St.	•	•	•	•	•
925 Silber 10 St.	•	•	•	•	•
925 Silber 100 St.	•	•	•	•	•
925 Silber GGP 05 1 St.	•	•	•	•	•
925 Silber GGP 05 10 St.	•	•	•	•	•
925 Silber GGP 05 100 St.	•	•	•	•	•
585 GG 1 St.	•				
585 GG 10 St.	•				

2-Loch-Kugeln, diamantiert

schwere Standardausführung

Diagonal-Schnitt, rund







Nr. 37040

2-hole-beads, diamond-cutted

heavy, strong standard version

square cut, round

2-Loch-Kugeln, diamantiert, Diagonal-Schnitt; mehrreihig 2-hole-beads, diamond cut- ted, diagonal cutting					
Kugel-Ø in mm ca.	2,5	3,0	4,0	5,0	6,0
Bohrung-Ø in mm ca.	1,2	1,2	1,5	1,5	1,8
Artikel-Nr.	37025	37030	37040	37050	37060
925 Silber 1 St.	•	•	•	•	•
925 Silber 10 St.	•	•	•	•	•
925 Silber 100 St.	•	•	•	•	•
925 Silber GGP 05 1 St.	•	•	•	•	•
925 Silber GGP 05 10 St.	•	•	•	•	•
925 Silber GGP 05 100 St.	•	•	•	•	•

2-Loch-Kugeln, diamantiert
schwere Standardausführung
 Pfeil-Schnitt, rund

2-hole-beads, diamond-cutted
heavy, strong standard version
 arrow cut, round



Nr. 38040

2-Loch-Kugeln, diamantiert, Pfeil-Schnitt 2-hole-beads, diamond cut- ted, arrow cutting					
Kugel-Ø in mm ca.	3,0	4,0	5,0	6,0	
Bohrung-Ø in mm ca.	1,2	1,5	1,5	1,8	
Artikel-Nr.	38030	38040	38050	38060	
925 Silber 1 St.	•	•	•	•	
925 Silber 10 St.	•	•	•	•	
925 Silber 100 St.	•	•	•	•	
925 Silber GGP 05 1 St.	•	•	•	•	
925 Silber GGP 05 10 St.	•	•	•	•	
925 Silber GGP 05 100 St.	•	•	•	•	

2-Loch-Kugeln, diamantiert
schwere Standardausführung
 Mondsichel-Schnitt, rund

2-hole-beads, diamond-cutted
heavy, strong standard version
 crescent cut, round



Nr. 39040

2-Loch-Kugeln, diamantiert, Mondsichel-Schnitt 2-hole-beads, diamond cut- ted, crescent cutting					
Kugel-Ø in mm ca.	3,0	4,0	5,0	6,0	
Bohrung-Ø in mm ca.	1,2	1,5	1,5	1,8	
Artikel-Nr.	39030	39040	39050	39060	
925 Silber 1 St.	•	•	•	•	
925 Silber 10 St.	•	•	•	•	
925 Silber 100 St.	•	•	•	•	
925 Silber GGP 05 1 St.	•	•	•	•	
925 Silber GGP 05 10 St.	•	•	•	•	
925 Silber GGP 05 100 St.	•	•	•	•	

SUMA FURNITUREN





Mulde 10 D-75239 Eisingen • ☎ +49 (0) 7232 809 454 • 📠 +49 (0) 7232 809 453 • ✉ info@sumafurnituren.de • www.sumafurnituren.de



2-Loch-Kugeln, diamantiert
schwere Standardausführung
 verschiedene Diamantschnitte, rund

2-hole-beads, diamond-cutted
heavy, strong standard version
 various diamond cuttings, round

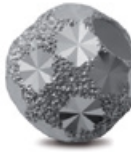

Die Kugeln sind ca. 200% vergrößert abgebildet für eine bessere Detailansicht.

2-Loch-Kugeln, diamantiert, 2-hole-beads, diamond cutted					
Kugel-Ø in mm ca.	6,0	6,0	6,0	6,0	6,0
Bohrung-Ø in mm ca.	1,8	1,8	1,8	1,8	1,8
Artikel-Nr.	35060A	35060B	35060C	35060D	35060E
925 Silber 1 St.	•	•	•	•	•
925 Silber 10 St.	•	•	•	•	•
925 Silber GGP 03 1 St.	•	•	•	•	•
925 Silber GGP 03 10 St.	•	•	•	•	•







2-Loch-Kugeln, diamantiert, 2-hole-beads, diamond cutted					
Kugel-Ø in mm ca.	6,0	6,0	6,0	6,0	
Bohrung-Ø in mm ca.	1,8	1,8	1,8	1,8	
Artikel-Nr.	35060F	35060G	35060H	35060I	
925 Silber 1 St.	•	•	•	•	
925 Silber 10 St.	•	•	•	•	
925 Silber GGP 03 1 St.	•	•	•	•	
925 Silber GGP 03 10 St.	•	•	•	•	



Drahtgeflecht-Kugeln schwere Standardausführung 2-Loch-Kugeln

Mesh-beads heavy, strong standard version 2-hole-beads



7107

rund round						
Ø in mm ca.	4,0	5,0	6,0	7,0	8,0	10,0
Artikel-Nr.	7104	7105	7106	7107	7108	7110
925 Silber 1 St.	•	•	•	•	•	•
925 Silber 10 St.	•	•	•	•	•	•
925 Silber 100 St.	•	•	•	•	•	•
925 Silber GGP 05 1 St.	•	•	•	•	•	•
925 Silber GGP 05 10 St.	•	•	•	•	•	•
925 Silber GGP 05 100 St.	•	•	•	•	•	•
585 GG 1 St.	•	•	•			
585 GG 10 St.	•	•	•			
750 GG 1 St.	•	•	•			
750 GG 10 St.	•	•	•			

rund round						
Ø in mm ca.	12,0	14,0				
Artikel-Nr.	7112	7114				
925 Silber 1 St.	•	•				
925 Silber 10 St.	•	•				
925 Silber GGP 05 1 St.	•	•				
925 Silber GGP 05 10 St.	•	•				

1-Loch-Kugeln

schwere Standardausführung

glatt, rund

1-hole-beads

heavy, strong standard version

smooth, round



Kugel-Ø in mm ca.	3	4	5	6	7	8	9	10
Bohrung-Ø in mm ca.	1,0	1,0	1,0	1,0	1,0	1,5	1,5	2,0
Wandstärke in mm ca.	0,2	0,25	0,3	0,4	0,5	0,5	0,5	0,5
Artikel-Nr.	312/3	312/4	312/5	312/6	312/7	312/8	312/9	312/10
935 Silber 1 St.	•	•	•	•	•	•	•	•
935 Silber 10 St.	•	•	•	•	•	•	•	•
935 Silber 100 St.	•	•	•	•	•	•	•	•
585 GG 1 St.	•	•	•	•	•	•	•	•
585 RotG 1 St.	•	•						
585 WG Pd 1 St.	•	•	•	•		•		
750 GG 1 St.	•	•	•	•	•	•		•
750 RoseG 1 St.						•		
750 RotG 1 St.	•	•		•				
750 WG 1 St.		•		•		•		

Kugel-Ø in mm ca.	11	12	13	14	16	18
Bohrung-Ø in mm ca.	2,0	2,3	2,5	2,5	2,8	3,5
Wandstärke in mm ca.	0,6	0,6	0,6	0,6	0,6	0,8
Artikel-Nr.	312/11	312/12	312/13	312/14	312/16	312/18
935 Silber 1 St.	•	•	•	•	•	•
935 Silber 10 St.	•	•	•	•	•	•
585 GG 1 St.		•				
750 GG 1 St.		•				
750 RotG 1 St.		•				
750 WG 1 St.	•	•				



Bedingt durch die Fertigungsweise sind die angegebenen Lochgrößen nur Anhaltswerte und können innerhalb einer Charge davon abweichen.

1-Loch-Kugeln in weiteren Größen und Goldlegierungen auf Anfrage!

1-Loch-Kugeln

*extra-schwere Ausführung
zum Ausfassen geeignet
glatt, rund*

1-hole-beads

*extra heavy, strong version
suitable for setting
smooth, round*

					
Kugel-Ø in mm ca.	8				
Bohrung-Ø in mm ca.	1,5				
Wandstärke in mm ca.	0,9				
Artikel-Nr.	314/8				
750 GG	1 St.	•			



Bedingt durch die Fertigungsweise sind die angegebenen Lochgrößen nur Anhaltswerte und können innerhalb einer Charge davon abweichen.







1-Loch-Kugeln in weiteren Größen und Goldlegierungen auf Anfrage!

1-Loch-Kugeln

*leichte Ausführung, gelötete Qualität
glatt, rund*

1-hole-beads





*light version, soldered quality
smooth, round*



gelötete Qualität soldered quality							
Kugel-Ø in mm ca.	10,0	12,0	14,0	16,0	18,0	20,0	23,0
Bohrung-Ø in mm ca.	1,5	1,5	1,5	1,5	1,5	1,5	1,5
Wandstärke in mm ca.	0,3	0,3	0,3	0,3	0,3	0,3	0,3
Artikel-Nr.	316/10	316/12	316/14	316/16	316/18	316/20	316/23
925 Silber	1 St.	•	•	•	•	•	•
925 Silber	10 St.	•	•	•	•	•	•

Silber-Kugeln Linsenform 925/- silver flat beads (lenses) 925/-
schwere Standardausführung heavy, strong standard version
 2-Loch, glatt, rund 2 holes, smooth, round



Seitenansicht
Side view

					
Ø x Höhe in mm ca.	3,3 x 2,0	4,4 x 2,8	5,5 x 3,5	6,7 x 4,3	8,0 x 4,5
Bohrung in mm ca.	1,0	1,2	1,6	1,5	1,5
Artikel-Nr.	6303	6304	6306	6307	6308
925 Silber 1 St.	•	•	•	•	•
925 Silber 10 St.	•	•	•	•	•
925 Silber 100 St.	•	•	•	•	•
925 Silber 500 St.	•	•	•	•	•

					
Ø x Höhe in mm ca.	9,5 x 5,5	10,6 x 5,9			
Bohrung in mm ca.	1,6	1,5			
Artikel-Nr.	6309	6310			
925 Silber 1 St.	•	•			
925 Silber 10 St.	•	•			

Gold-Kugeln Linsenform

leichte Ausführung

2-Loch, glatt, nur für Auffädelarbeiten empfohlen



Gold flat beads (lenses)

light version

2-holes, smooth, recommended only for beading



Seitenansicht
Side view





						
Ø x Höhe in mm ca.	4,6 x 2,5	5,8 x 3,3	7,1 x 3,8			
Bohrung in mm ca.	1,2	1,3	1,4			
Artikel-Nr.	6304	6306	6307			
585 GG	1 St.	•	•			
585 GG	10 St.	•	•			
750 GG	1 St.			•		
750 GG	10 St.			•		

schwere Standardausführung
2-Loch, glatt

heavy, strong standard version
2 holes, smooth



Seitenansicht
Side view

						
Ø x Höhe in mm ca.	3,3 x 2,25	4,4 x 3,0	5,9 x 3,5	7,0 x 3,8		
Bohrung in mm ca.	1,2	1,3	1,3	1,5		
Artikel-Nr.	6903	6904	6906	6907		
585 GG	1 St.	•	•	•	•	
585 GG	10 St.	•	•	•	•	
750 GG	1 St.	•	•	•	•	
750 GG	10 St.	•	•	•	•	

SUMA FURNITUREN

Mulde 10 D-75239 Eisingen • ☎ +49 (0) 7232 809 454 • 📠 +49 (0) 7232 809 453 • ✉ info@sumafurnituren.de • www.sumafurnituren.de

Kugeln Satellitenform
schwere Standardausführung
 2-Loch, glatt

flat beads (satellite)
heavy, strong standard version
 2 holes, smooth



Nr. 63404

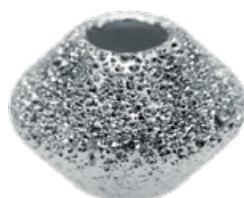

Nr. 64204

2-Loch-Kugeln „Satellit“, glatt und Sterneffekt 2-hole beads „satellite“, smooth and with star dust						
	** Abbildungen sind um 100% vergrößert **					
Ø x Höhe in mm ca.	3,3 x 2,2	4,4 x 3,0	5,7 x 3,8	6,8 x 4,7		
Artikel-Nr.	64103	64104	64106	64107		
925 Silber 1 St.	•	•	•	•		
925 Silber 10 St.	•	•	•	•		
925 Silber 100 St.	•	•	•	•		
925 Silber GGP 05 1 St.	•	•	•	•		
925 Silber GGP 05 10 St.	•	•	•	•		
925 Silber GGP 05 100 St.	•	•	•	•		

Kugeln Satellitenform
schwere Standardausführung
 2-Loch, glatt, Sterneffekt

flat beads (satellite)
heavy, strong standard version
 2 holes, smooth, star dust





2-Loch-Kugeln „Satellit“, glatt und Sterneffekt 2-hole beads „satellite“, smooth and with star dust						
	** Abbildungen sind um 100% vergrößert **					
Ø x Höhe in mm ca.	3,3 x 2,2	4,4 x 3,0				
Artikel-Nr.	64203	64204				
925 Silber 1 St.	•	•				
925 Silber 10 St.	•	•				
925 Silber 100 St.	•	•				
925 Silber GGP 05 1 St.	•	•				
925 Silber GGP 05 10 St.	•	•				
925 Silber GGP 05 100 St.	•	•				





Silber-Hohlringe 925/ schwere Standardausführung 2-Loch, glatt, rund

Silver roundels 925/ heavy, strong standard version 2 holes, smooth, round



Seitenansicht
Side view

					
Ø x Höhe in mm ca.	2,5 x 1,1	3,0 x 1,6	4,3 x 2,2	5,2 x 2,8	6,5 x 3,3
Bohrung-Ø in mm ca.	1,0	1,1	1,5	2,0	2,0
Artikel-Nr.	6102	6103	6104	6105	6106
925 Silber 10 St.	•	•	•	•	•
925 Silber 100 St.	•	•	•	•	•
925 Silber 500 St.	•	•	•	•	•

					
Ø x Höhe in mm ca.	7,5 x 4,0	8,0 x 4,2	11,4 x 5,8	16,3 x 9,0	
Bohrung-Ø in mm ca.	2,5	2,0	2,5	2,7	
Artikel-Nr.	6107	6108	6111	6116	
925 Silber 1 St.	•	•	•	•	
925 Silber 10 St.	•	•	•	•	
925 Silber 100 St.	•	•			
925 Silber 500 St.	•				

SUMA FURNITUREN

Mulde 10 D-75239 Eisingen • ☎ +49 (0) 7232 809 454 • 📠 +49 (0) 7232 809 453 • ✉ info@sumafurnituren.de • www.sumafurnituren.de

Gold-Hohlringe 585/- 750/-

leichte Ausführung

2-Loch, glatt, rund, nur für Auffädelarbeiten empfohlen







Gold roundels 585/- 750/-

light version

2 holes, smooth, round, recommended only for beading



Seitenansicht
Side view

						
Ø x Höhe in mm ca.	3,2 x 1,5	4,1 x 2,1	5,0 x 2,7	6,1 x 3,3	7,0 x 3,7	8,1 x 4,2
Bohrung-Ø in mm ca.	1,3	1,5	1,5	1,5	1,8	2,2
Artikel-Nr.	6103	6104	6105	6106	6107	6108
585 GG 1 St.	•	•	•	•	•	•
585 GG 10 St.	•	•	•			
750 GG 1 St.	•	•	•	•		
750 GG 10 St.	•	•	•			

Gold-Hohlringe 585/- 750/-





schwere Standardausführung

2-Loch, glatt, rund

Gold roundels 585/- 750/-

heavy, strong standard version

2 holes, smooth, round

					
Ø x Höhe in mm ca.	3,3 x 1,65	4,3 x 2,2	5,1 x 3,0	6,5 x 3,4	
Bohrung-Ø in mm ca.	1,4	1,8	2,0	2,2	
Artikel-Nr.	6703	6704	6705	6706	
585 GG 1 St.	•	•	•	•	
585 GG 10 St.	•	•	•	•	
750 GG 1 St.	•	•	•	•	
750 GG 10 St.	•	•	•	•	

Hohlringe





schwere Standardausführung

2-Loch, Sterneffekt, rund

Roundels

heavy, strong standard version

2 holes, star dust, round

				
Ø x Höhe in mm ca.	3,5 x 1,7	4,4 x 2,3	5,3 x 3,0	6,8 x 3,5
Bohrung-Ø in mm ca.	1,0	1,3	1,7	1,7
Artikel-Nr.	6803	6804	6805	6806
925 Silber 1 St.	•	•	•	•
925 Silber 10 St.	•	•	•	•
925 Silber 100 St.	•	•	•	•
925 Silber GGP 05 1 St.	•	•	•	•
925 Silber GGP 05 10 St.	•	•	•	•
925 Silber GGP 05 100 St.	•	•	•	•
585 GG 1 St.		•		
750 GG 1 St.	•			



Silber GGP 05 = plattierte Goldauflage mit 5 Milliem Stärke

Hohlringe

schwere Standardausführung

2-Loch, diamantiert, rund



Roundels

heavy, strong standard version

2 holes, with diamond cut, round



Nr. 37040

Diamantierte Hohlringe Roundels with diamond cut						
	** Abbildungen sind um 100% vergrößert **					
Ø in mm ca.	3	4	5			
Artikel-Nr.	37530	37540	37550			
925 Silber 1 St.	•	•	•			
925 Silber 10 St.	•	•	•			
925 Silber 100 St.	•	•	•			
925 Silber GGP 05 1 St.	•	•	•			
925 Silber GGP 05 10 St.	•	•	•			
925 Silber GGP 05 100 St.	•	•	•			

Silber-Hohlringe 925/-, flach

schwere Standardausführung

2-Loch, glatt, rund



Silver roundels 925/-, flat

heavy, strong standard version

2 holes, smooth, round



Seitenansicht
Side view

					
Ø x Höhe in mm ca.	3,0 x 1,2	4,6 x 1,6	5,6 x 2,2		
Bohrung-Ø in mm ca.	1,2	1,5	1,8		
Artikel-Nr.	65103	65104	65105		
925 Silber 1 St.	•	•	•		
925 Silber 10 St.	•	•	•		
925 Silber 100 St.	•	•	•		

Silber-Oliven 925/-

schwere Standardausführung

2-Loch, diamantiert



Silver olives 925/-

heavy, strong standard version

2 holes, with diamond cut



Nr. 37770

					
2-Loch-Kugeln Olive, diamantiert 2-hole beads olive shape, with diamond cut					
	** Abbildungen sind um 100% vergrößert **				
Ø / Länge x Ø in mm ca.	4,5 x 3	7 x 4	8 x 5		
Artikel-Nr.	37740	37770	37780		
925 Silber 1 St.	•	•	•		
925 Silber 10 St.	•	•	•		
925 Silber 100 St.	•	•	•		
925 Silber GGP 03 1 St.	•	•	•		
925 Silber GGP 03 10 St.	•	•	•		
925 Silber GGP 03 100 St.	•	•	•		

Drahtgeflecht-Kugeln schwere Standardausführung 2-Loch-Kugeln

Mesh-beads heavy, strong standard version 2-hole-beads

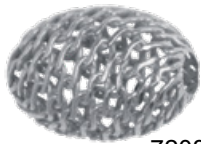

7208

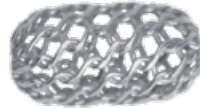

7306



6608

oval oval				
Breite x Länge in mm ca.	4,0 x 5,0	5,0 x 7,0	6,0 x 9,0	8,0 x 11,5
Artikel-Nr.	7204	7205	7206	7208
925 Silber 1 St.	•	•	•	•
925 Silber 10 St.	•	•	•	•
925 Silber 100 St.	•	•	•	•
925 Silber GGP 05 1 St.	•	•	•	•
925 Silber GGP 05 10 St.	•	•	•	•
925 Silber GGP 05 100 St.	•	•	•	•
750 GG 1 St.	•	•		

oval oval				
Breite x Länge in mm ca.	10,0 x 17,0	12,2 x 19,2	14,0 x 22,0	
Artikel-Nr.	7210	7212	7214	
925 Silber 1 St.	•	•	•	
925 Silber 10 St.	•	•	•	
925 Silber GGP 05 1 St.	•	•	•	
925 Silber GGP 05 10 St.	•	•	•	





zylindrisch, birnen-förmig cylindrical, pear-shaped					
Breite x Länge in mm ca.	4,0 x 9,0	6,0 x 11,0	8,0 x 15,0	8,1 x 12,2	
Artikel-Nr.	7304	7306	7308	6608	
925 Silber 1 St.	•	•	•	•	
925 Silber 10 St.	•	•	•	•	
925 Silber 100 St.	•	•			
925 Silber GGP 05 1 St.	•	•	•	•	
925 Silber GGP 05 10 St.	•	•	•	•	
925 Silber GGP 05 100 St.	•	•			





Silber-Würfel 925/-
schwere Standardausführung
 2-Loch, glatt, rund

Silver cubes 925/-
heavy, strong standard version
 2 holes, smooth, round



Nr. 66050

2-Loch-Kugeln „Würfel“, glatt 2-hole beads „cube“, smooth						
Maße / Ø in mm ca.	2 x 2	2,5 x 2,5	3 x 3	4 x 4	5 x 5	
Artikel-Nr.	66020	66025	66030	66040	66050	
925 Silber 1 St.	•	•	•	•	•	
925 Silber 10 St.	•	•	•	•	•	
925 Silber 100 St.	•	•	•			

Abstandsringe mit extra großer Bohrung, glatt Spacers with extra big holes, plain					
Außen-Ø in mm ca.	4,0	5,0	6,0	7,0	8,0
Bohrungs-Ø in mm ca.	2,4	3,2	4,0	4,6	5,2
Artikel-Nr.	6004	6005	6006	6007	6008
925 Silber 1 St.	•	•	•	•	•
925 Silber 10 St.	•	•	•	•	•
925 Silber 100 St.	•	•	•	•	•



281E/10



281EM/10



287C/10



287CM/10



381E/10



382C/10



383E/10



Silber GGP 05 = plattierte Goldauflage mit 5 Milliem Stärke



Rohrabschnitte, rund Tubes, round							
Außen-Ø in mm ca.	2,0	3,0	4,0	5,0	2,0	2,5	3,0
Länge in mm ca.	10,0	10,0	10,0	10,0	10,0	10,0	10,0
	glatt / smooth				Sterneffekt / star dust		
Artikel-Nr.	281C/10	281E/10	281F/10	281G/10	281CM/10	281DM/10	281EM/10
925 Silber 1 St.	•	•	•	•	•	•	•
925 Silber 10 St.	•	•	•	•	•	•	•
925 Silber 100 St.	•	•	•	•	•	•	•
925 Silber GGP 05 1 St.	•	•	•	•	•	•	•
925 Silber GGP 05 10 St.	•	•	•	•	•	•	•
925 Silber GGP 05 100 St.	•	•	•	•	•	•	•







Rohrabschnitte, quadra- tisch Tubes, quadratical						
Außen-Ø in mm ca.	2,0 x 2,0	2,5 x 2,5	3,0 x 3,0	2,0 x 2,0		
Länge in mm ca.	10,0	10,0	10,0	10,0		
	glatt / smooth			Sterneffekt / star dust		
Artikel-Nr.	287C/10	287D/10	287E/10	287CM/10		
925 Silber 1 St.	•	•	•	•		
925 Silber 10 St.	•	•	•	•		
925 Silber 100 St.	•	•	•	•		
925 Silber GGP 05 1 St.	•	•	•	•		
925 Silber GGP 05 10 St.	•	•	•	•		
925 Silber GGP 05 100 St.	•	•	•	•		



Rohrabschnitte, rund, dia- mantiert Tubes, round, with dia- mond-cut							
Außen-Ø in mm ca..	2,0	3,0	2,0	3,0	2,0	3,0	
Länge in mm ca.	10,0	10,0	10,0	10,0	10,0	10,0	
Artikel-Nr.	381C/10	381E/10	382C/10	382E/10	383C/10	383E/10	
925 Silber 1 St.	•	•	•	•	•	•	
925 Silber 10 St.	•	•	•	•	•	•	
925 Silber 100 St.	•	•	•	•	•	•	
925 Silber GGP 05 1 St.	•	•	•	•	•	•	
925 Silber GGP 05 10 St.	•	•	•	•	•	•	
925 Silber GGP 05 100 St.	•	•	•	•	•	•	





SUMA FURNITUREN

Mulde 10 D-75239 Eisingen • ☎ +49 (0) 7232 809 454 • 📠 +49 (0) 7232 809 453 • ✉ info@sumafurnituren.de • www.sumafurnituren.de

Glatte Endschalen mit Bohrung Smooth endcaps with hole						
Ø in mm ca.	3,2	4,0	5,0			
Bohrung in mm ca.	0,70	0,70	0,70			
Artikel-Nr.	76030	76040	76050			
935 Silber 10 St.	•	•	•			
935 Silber 100 St.	•	•	•			
585 GG 1 St.	•	•	•			
585 RotG 1 St.		•				
585 WG Pd 1 St.	•	•	•			
750 GG 1 St.	•	•	•			
750 RoseG 1 St.			•			
750 WG Pd 1 St.	•	•	•			





Filigran-Endschalen mit Bohrung Filigree endcaps with hole						
Ø in mm ca.	3,9	5,3	6,3	7,3	8,5	11,5
Bohrung in mm ca.	1,0	1,0	1,1	1,1	1,1	1,2
Artikel-Nr.	320/4	320/5	320/6	320/7	320/8	320/12
935 Silber 1 St.	•	•	•	•	•	•
935 Silber 10 St.	•	•	•	•	•	•
935 Silber 100 St.	•	•	•	•	•	•





Ronden mit Bohrung, Materialstärke 0,4 mm Round Plates, with hole						
Ø in mm ca.	6	8	10			
Blechstärke in mm ca.	0,4	0,4	0,4			
Artikel-Nr.	70060/0,4	70080/0,4	70100/0,4			
585 GG 1 St.	•	•	•			
585 WG 1 St.	•	•	•			
750 GG 1 St.	•	•	•			
750 WG 1 St.	•	•	•			



Ronden mit Bohrung, Materialstärke 0,6 mm Round Plates, with hole						
Ø in mm ca.	6	8	10	12	14	
Blechstärke in mm ca.	0,6	0,6	0,6	0,6	0,6	
Artikel-Nr.	70060/0,6	70080/0,6	70100/0,6	70120/0,6	70140/0,6	
935 Silber 1 St.	•	•	•	•	•	
935 Silber 10 St.	•	•	•	•	•	
935 Silber 100 St.	•	•	•	•	•	



SUMA FURNITUREN

Mulde 10 D-75239 Eisingen • ☎ +49 (0) 7232 809 454 • 📠 +49 (0) 7232 809 453 • ✉ info@sumafurnituren.de • www.sumafurnituren.de

Ronden ohne Bohrung, Materialstärke 0,4 mm Round Plates, no hole						
Ø in mm ca.	6	8	10	12	14	
Blechstärke in mm ca.	0,4	0,4	0,4	0,4	0,4	
Artikel-Nr.	75060/0,4	75080/0,4	75100/0,4	75120/0,4	75140/0,4	
585 GG 1 St.	•	•	•	•	•	
585 WG 1 St.	•	•	•			
750 GG 1 St.	•	•	•			
750 WG 1 St.	•	•	•			

Ronden ohne Bohrung, Materialstärke 0,6 mm Round Plates, no hole						
Ø in mm ca.	6	8	10	12	14	
Blechstärke in mm ca.	0,6	0,6	0,6	0,6	0,6	
Artikel-Nr.	75060/0,6	75080/0,6	75100/0,6	75120/0,6	75140/0,6	
935 Silber 1 St.	•	•	•	•	•	
935 Silber 10 St.	•	•	•	•	•	
935 Silber 100 St.	•	•	•	•	•	

Ronden ohne Bohrung, Materialstärke 0,8 mm Round Plates, no hole						
Ø in mm ca.		8	10			
Blechstärke in mm ca.		0,8	0,8			
Artikel-Nr.		75080/0,8	75100/0,8			
935 Silber 1 St.		•	•			
935 Silber 10 St.		•	•			
935 Silber 100 St.		•	•			

Ronden ohne Bohrung, Materialstärke 1,0 mm Round Plates, no hole						
Ø in mm ca.		8	10			
Blechstärke in mm ca.		1,0	1,0			
Artikel-Nr.		75080/1,0	75100/1,0			
935 Silber 1 St.		1,80	2,40			
935 Silber 10 St.		16,20	21,40			
935 Silber 100 St.		149,00	199,00			
585 GG 1 St.		61,10	92,50			

Collierketten, Armbänder

Necklaces, Bracelets

Auf Wunsch können alle Ketten auch in **Silber vergoldeter**, **Silber goldplattierter** und **Silber rhodiniertes** Ausführung geliefert werden. Weitere Informationen dazu finden Sie auf der Seite II unter „Galvanik“.

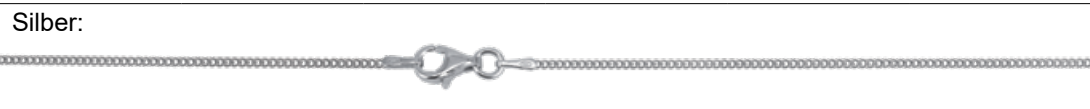
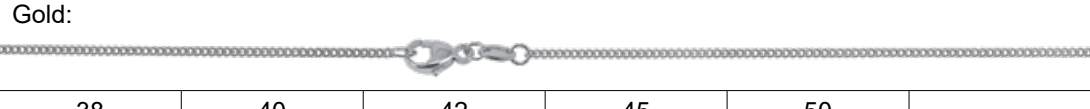

Panzer flach Draht-Ø 0,30 mm Curb Chain flat Wire-Ø 0,30 mm Kettenbreite: ca. 1,1 mm						
	Länge in cm ca.	38	40	42	45	50
Artikel-Nr.	13030/38	13030/40	13030/42	13030/45	13030/50	
925 Silber 1 St.	•	•	•	•	•	
925 Silber 10 St.	•	•	•	•	•	
585 GG 1 St.		•	•	•		
585 WG RH 1 St.		•	•	•		
750 GG 1 St.		•	•	•		

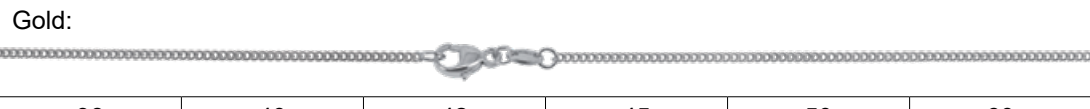

Panzer flach Draht-Ø 0,35 mm Curb Chain flat Wire-Ø 0,35 mm Kettenbreite: ca. 1,3 mm	Silber: 					
	Gold: 					
Länge in cm ca.	38	40	42	45	50	
Artikel-Nr.	13035/38	13035/40	13035/42	13035/45	13035/50	
925 Silber 1 St.	•	•	•	•	•	
925 Silber 10 St.	•	•	•	•	•	
333 GG 1 St.	•	•	•	•	•	
585 GG 1 St.	•	•	•	•	•	
750 GG 1 St.	•	•	•	•	•	



Panzer flach Draht-Ø 0,40 mm Curb Chain flat Wire-Ø 0,40 mm Kettenbreite: ca. 1,4 mm	Silber: 					
	Gold: 					
Länge in cm ca.	38	40	42	45	50	60
Artikel-Nr.	13040/38	13040/40	13040/42	13040/45	13040/50	13040/60
925 Silber 1 St.	•	•	•	•	•	•
925 Silber 10 St.	•	•	•	•	•	•
333 GG 1 St.		•	•	•	•	•
585 GG 1 St.	•	•	•	•	•	•
585 WG RH 1 St.	•	•	•	•	•	•
750 GG 1 St.	•	•	•	•	•	•

SUMA FURNITUREN

Mulde 10 D-75239 Eisingen ● ☎ +49 (0) 7232 809 454 ● 📠 +49 (0) 7232 809 453 ● ✉ info@sumafurnituren.de ● www.sumafurnituren.de

Panzer flach Draht-Ø 0,45 mm Curb Chain flat Wire-Ø 0,45 mm Kettenbreite: ca. 1,6 mm	Silber:						
							
	Gold:						
							
Länge in cm ca.	38	40	42	45	50	60	70
Artikel-Nr.	13045/38	13045/40	13045/42	13045/45	13045/50	13045/60	13045/70
925 Silber 1 St.	•	•	•	•	•	•	•
925 Silber 10 St.	•	•	•	•	•	•	•
333 GG 1 St.		•	•	•	•		
585 GG 1 St.	•	•	•	•	•	•	
750 GG 1 St.	•	•	•	•	•	•	

Panzer flach Draht-Ø 0,50 mm Curb Chain flat Wire-Ø 0,50 mm Kettenbreite: ca. 1,8 mm	Silber:						
							
	Gold:						
							
Länge in cm ca.	40	42	45	50	60	70	80
Artikel-Nr.	13050/40	13050/42	13050/45	13050/50	13050/60	13050/70	13050/80
925 Silber 1 St.	•	•	•	•	•	•	•
925 Silber 10 St.	•	•	•	•	•	•	•
585 GG 1 St.	•	•	•	•	•		
750 GG 1 St.	•	•	•	•			

Panzer flach Draht-Ø 0,60 mm Curb Chain flat Wire-Ø 0,60 mm Kettenbreite: ca. 2,2 mm	Silber:							
								
	Gold:							
								
Länge in cm ca.	40	42	45	50	60	70	80	90
Artikel-Nr.	13060/40	13060/42	13060/45	13060/50	13060/60	13060/70	13060/80	13060/90
925 Silber 1 St.	•	•	•	•	•	•	•	•
925 Silber 10 St.	•	•	•	•	•	•	•	•
585 GG 1 St.	•	•	•	•	•			
585 WG RH 1 St.		•	•					
750 GG 1 St.		•	•	•				

Panzer flach Draht-Ø 0,80 mm Curb Chain flat Wire-Ø 0,80 mm Kettenbreite: ca. 2,7 mm	Silber:							
								
Länge in cm ca.	40	42	45	50	60	70	80	90
Artikel-Nr.	13080/40	13080/42	13080/45	13080/50	13080/60	13080/70	13080/80	13080/90
925 Silber 1 St.	•	•	•	•	•	•	•	•
925 Silber 10 St.	•	•	•	•	•	•	•	•

Panzer flach Draht-Ø 1,0 mm Curb Chain flat Wire-Ø 1,0 mm Kettenbreite: ca. 3,3 mm							
Länge in cm ca.	40	42	45	50	60	70	80
Artikel-Nr.	13100/40	13100/42	13100/45	13100/50	13100/60	13100/70	13100/80
925 Silber 1 St.	•	•	•	•	•	•	•

Panzer flach Draht-Ø 1,2 mm Curb Chain flat Wire-Ø 1,2 mm Kettenbreite: ca. 4,2 mm							
Länge in cm ca.	42	45	50	60	70	80	
Artikel-Nr.	13120/42	13120/45	13120/50	13120/60	13120/70	13120/80	
925 Silber 1 St.	•	•	•	•	•	•	•

Panzer flach Draht-Ø 1,5 mm Curb Chain flat Wire-Ø 1,5 mm Kettenbreite: ca. 4,8 mm							
Länge in cm ca.	19	21	42	45	50	60	
Artikel-Nr.	13150/19	13150/21	13150/42	13150/45	13150/50	13150/60	
925 Silber 1 St.	•	•	•	•	•	•	•

Panzer flach Draht-Ø 1,8 mm Curb Chain flat Wire-Ø 1,8 mm Kettenbreite: ca. 5,2 mm							
Länge in cm ca.	19,5	21	42	45	50	60	
Artikel-Nr.	13180/19	13180/21	13180/42	13180/45	13180/50	13180/60	
925 Silber 1 St.	•	•	•	•	•	•	•

SUMA FURNITUREN

Mulde 10 D-75239 Eisingen • ☎ +49 (0) 7232 809 454 • 📠 +49 (0) 7232 809 453 • ✉ info@sumafurnituren.de • www.sumafurnituren.de

Panzerketten, 4-fach diamantiert Curb chains, 4 sides diamond cutted

Panzer 2,00 Curb Chain 2,00 Kettenbreite ca. 6,2 mm							
Länge in cm ca.		19	21	42	45	50	60
Artikel-Nr.		13200/19	13200/21	13200/42	13200/45	13200/50	13200/60
925 Silber	1 St.	•	•	•	•	•	•

Panzer 2,20 Curb Chain 2,20 Kettenbreite ca. 7,0 mm							
Länge in cm ca.		19	21	42	45	50	60
Artikel-Nr.		13220/19	13220/21	13220/42	13220/45	13220/50	13220/60
925 Silber	1 St.	•	•	•	•	•	•

Panzer 2,50 Curb Chain 2,50 Kettenbreite ca. 7,2 mm							
Länge in cm ca.		19	21	42	45	50	60
Artikel-Nr.		13250/19	13250/21	13250/42	13250/45	13250/50	13250/60
925 Silber	1 St.	•	•	•	•	•	•

Panzer 3,00 Curb Chain 3,00 Kettenbreite ca. 9,5 mm							
Länge in cm ca.		19	21	42	45	50	60
Artikel-Nr.		13300/19	13300/21	13300/42	13300/45	13300/50	13300/60
925 Silber	1 St.	•	•	•	•	•	•

Panzer 3,50 Curb Chain 3,50 Kettenbreite ca. 10,5 mm							
Länge in cm ca.		19	21	42	45	50	60
Artikel-Nr.		13350/19	13350/21	13350/42	13350/45	13350/50	13350/60
925 Silber	1 St.	•	•	•	•	•	•

Panzerketten, 6-fach diamantiert
Curb chains, 6 sides diamond cutted

Panzer 2,20 Curb Chain 2,20 Kettenbreite ca. 8,1 mm							
Länge in cm ca.		19	21	42	45	50	60
Artikel-Nr.		19220/19	19220/21	19220/42	19220/45	19220/50	19220/60
925 Silber	1 St.	•	•	•	•	•	•

Panzer 2,50 Curb Chain 2,50 Kettenbreite ca. 9,3 mm							
Länge in cm ca.		19	21	42	45	50	60
Artikel-Nr.		19250/19	19250/21	19250/42	19250/45	19250/50	19250/60
925 Silber	1 St.	•	•	•	•	•	•

Panzer 3,0 Curb Chain 3,0 Kettenbreite ca. 11,4 mm							
Länge in cm ca.		19	21	42	45	50	60
Artikel-Nr.		19300/19	19300/21	19300/42	19300/45	19300/50	19300/60
925 Silber	1 St.	•	•	•	•	•	•

Panzer 3,50 Curb Chain 3,50 Kettenbreite ca. 13,4 mm							
Länge in cm ca.		19	21	42	45	50	60
Artikel-Nr.		19350/19	19350/21	19350/42	19350/45	19350/50	19350/60
925 Silber	1 St.	•	•	•	•	•	•

SUMA FURNITUREN

Mulde 10 D-75239 Eisingen • ☎ +49 (0) 7232 809 454 • 📠 +49 (0) 7232 809 453 • ✉ info@sumafurnituren.de • www.sumafurnituren.de

Panzer rund Draht-Ø 0,35 mm Curb Chain round Wire-Ø 0,35 mm Kettenbreite: ca. 1,3 mm						
	Länge in cm ca.	40	42	45	50	
Artikel-Nr.	13035R/40	13035R/42	13035R/45	13035R/50		
925 Silber	1 St.	•	•	•	•	
925 Silber	10 St.	•	•	•	•	

Panzer rund Draht-Ø 0,40 mm Curb Chain round Wire-Ø 0,40 mm Kettenbreite: ca. 1,4 mm						
	Länge in cm ca.	40	42	45	50	
Artikel-Nr.	13040R/40	13040R/42	13040R/45	13040R/50		
925 Silber	1 St.	•	•	•	•	
925 Silber	10 St.	•	•	•	•	

Figaro-Panzer 0,40 Figaro Chain 0,40 Silber: Kettenbreite: ca. 1,8 mm Gold: Kettenbreite: ca. 1,3 mm									
Länge in cm ca.		38	40	42	45	50	60	70	80
Artikel-Nr.		13640/38	13640/40	13640/42	13640/45	13640/50	13640/60	13640/70	13640/80
925 Silber	1 St.	•	•	•	•	•	•	•	•
925 Silber	10 St.	•	•	•	•	•	•	•	•
585 GG	1 St.	•	•	•	•	•	•		

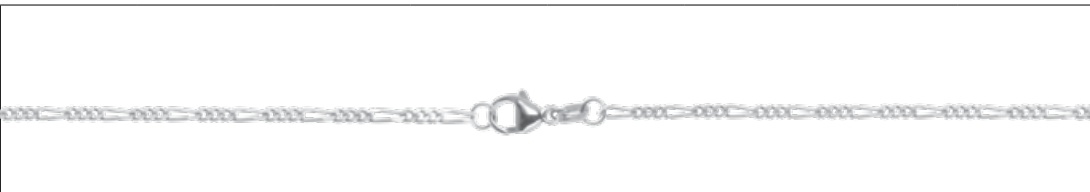
Figaro-Panzer 0,50 Figaro Chain 0,50 Silber: Kettenbreite: ca. 2,0 mm Gold: Kettenbreite: ca. 1,7 mm									
Länge in cm ca.		38	40	42	45	50	60	70	80
Artikel-Nr.		13650/38	13650/40	13650/42	13650/45	13650/50	13650/60	13650/70	13650/80
925 Silber	1 St.	•	•	•	•	•	•	•	•
925 Silber	10 St.	•	•	•	•	•	•	•	•
585 GG	1 St.	•	•	•	•	•			

Figaro-Panzer 0,60 Figaro Chain 0,60 Kettenbreite: ca. 2,2 mm									
Länge in cm ca.		40	42	45	50	60	70	80	
Artikel-Nr.		13660/40	13660/42	13660/45	13660/50	13660/60	13660/70	13660/80	
925 Silber	1 St.	•	•	•	•	•	•	•	
925 Silber	10 St.	•	•	•	•	•	•	•	

Figaro-Panzer 0,80 Figaro Chain 0,80 Kettenbreite: ca. 2,8 mm									
Länge in cm ca.		19	21	42	45	50	60	70	80
Artikel-Nr.		13680/19	13680/21	13680/42	13680/45	13680/50	13680/60	13680/70	13680/80
Silber	1 St.	•	•	•	•	•	•	•	•
Silber	10 St.	•	•	•	•	•	•	•	•

Figaro-Panzer 1,00 Figaro Chain 1,00 Kettenbreite: ca. 3,7 mm									
Länge in cm ca.		19	21	42	45	50	60	70	80
Artikel-Nr.		13610/19	13610/21	13610/42	13610/45	13610/50	13610/60	13610/70	13610/80
925 Silber	1 St.	•	•	•	•	•	•	•	•
925 Silber	10 St.	•	•	•	•	•	•	•	•

SUMA FURNITUREN

Mulde 10 D-75239 Eisingen • ☎ +49 (0) 7232 809 454 • 📠 +49 (0) 7232 809 453 • ✉ info@sumafurnituren.de • www.sumafurnituren.de

Schlangenkette Ø 0,9 mm Snake Chain Ø 0,9 mm								
Länge in cm ca.		38	40	42	45	50		
Artikel-Nr.		1409/38	1409/40	1409/42	1409/45	1409/50		
585 GG	1 St.	•	•	•	•	•		
585 WG RH	1 St.	•	•	•	•	•		
750 GG	1 St.	•	•	•	•	•		
750 WG RH	1 St.	•	•	•	•	•		

Schlangenkette Ø 1,0 mm Snake Chain Ø 1,0 mm								
Länge in cm ca.		38	40	42	45	50	60	70
Artikel-Nr.		1410/38	1410/40	1410/42	1410/45	1410/50	1410/60	1410/70
925 Silber	1 St.	•	•	•	•	•	•	•
925 Silber	10 St.	•	•	•	•	•	•	•

Echte Schlangenkette Ø 1,2 mm Real Snake Chain Ø 1,2 mm									
Länge in cm ca.		38	40	42	45	50	60	70	80
Artikel-Nr.		1412/38	1412/40	1412/42	1412/45	1412/50	1412/60	1412/70	1412/80
925 Silber	1 St.	•	•	•	•	•	•	•	•
925 Silber	10 St.	•	•	•	•	•	•	•	•
585 GG	1 St.	•	•	•	•	•	•		
585 WG RH	1 St.	•	•	•	•	•	•		
750 GG	1 St.	•	•	•	•	•	•		
750 WG RH	1 St.	•	•	•	•	•	•		

Echte Schlangenkette Ø 1,4 mm Real Snake Chain Ø 1,4 mm									
Länge in cm ca.		40	42	45	50	60	70	80	90
Artikel-Nr.		1414/40	1414/42	1414/45	1414/50	1414/60	1414/70	1414/80	1414/90
925 Silber	1 St.	•	•	•	•	•	•	•	•
925 Silber	10 St.	•	•	•	•	•	•	•	•
585 GG	1 St.	•	•	•	•	•			
585 WG RH	1 St.	•	•	•	•	•			
750 GG	1 St.	•	•	•	•	•			
750 WG RH	1 St.	•	•	•	•	•			

Echte Schlangenkette Ø 1,6 mm Real Snake Chain Ø 1,6 mm									
Länge in cm ca.		40	42	45	50	60	70	80	90
Artikel-Nr.		1416/40	1416/42	1416/45	1416/50	1416/60	1416/70	1416/80	1416/90
925 Silber	1 St.	•	•	•	•	•	•	•	•
925 Silber	10 St.	•	•	•	•	•	•	•	•
585 GG	1 St.	•	•	•	•	•			
585 WG RH	1 St.	•	•	•	•				
750 GG	1 St.	•	•	•	•				
750 WG RH	1 St.	•	•	•	•				

Echte Schlangenkette Ø 1,9 mm Real Snake Chain Ø 1,9 mm									
Länge in cm ca.		40	42	45	50	60	70	80	90
Artikel-Nr.		1419/40	1419/42	1419/45	1419/50	1419/60	1419/70	1419/80	1419/90
925 Silber	1 St.	•	•	•	•	•	•	•	•
925 Silber	10 St.	•	•	•	•	•	•	•	•

Echte Schlangenkette Ø 2,4 mm Real Snake Chain Ø 2,4 mm									
Länge in cm ca.		40	42	45	50	60	70	80	90
Artikel-Nr.		1424/40	1424/42	1424/45	1424/50	1424/60	1424/70	1424/80	1424/90
925 Silber	1 St.	•	•	•	•	•	•	•	•
925 Silber	10 St.	•	•	•	•	•	•	•	•

SUMA FURNITUREN

Mulde 10 D-75239 Eisingen • ☎ +49 (0) 7232 809 454 • 📠 +49 (0) 7232 809 453 • ✉ info@sumafurnituren.de • www.sumafurnituren.de



Echte Schlangenkette Ø 3,0 mm Real Snake Chain Ø 3,0 mm									
Länge in cm ca.	40	42	45	50	60	70	80	90	
Artikel-Nr.	1430/40	1430/42	1430/45	1430/50	1430/60	1430/70	1430/80	1430/90	
925 Silber 1 St.	•	•	•	•	•	•	•	•	•
925 Silber 10 St.	•	•	•	•	•	•	•	•	•

Echte Schlangenkette Ø 3,0 mm Real Snake Chain Ø 3,0 mm									
Länge in cm ca.	19	21							
Artikel-Nr.	1430/19	1430/21							
925 Silber 1 St.	•	•							
925 Silber 10 St.	•	•							

Echte Schlangenkette Ø 4,0 mm Real Snake Chain Ø 4,0 mm										
Länge in cm ca.	19	40	42	45	50	60	70	80	90	
Artikel-Nr.	1440/19	1440/40	1440/42	1440/45	1440/50	1440/60	1440/70	1440/80	1440/90	
925 Silber 1 St.	•	•	•	•	•	•	•	•	•	•



Echte Schlangenkette Ø 5,0 mm Real Snake Chain Ø 5,0 mm										
Länge in cm ca.	19	42	45	50	60	70	80	90		
Artikel-Nr.	1450/19	1450/42	1450/45	1450/50	1450/60	1450/70	1450/80	1450/90		
925 Silber 1 St.	•	•	•	•	•	•	•	•	•	•

Echte Schlangenkette vierkant, 1,4 x 1,4 mm Real Snake chain, qua- dratical, 1,4 x 1,4 mm							
Länge in cm ca.	38	40	42	45	50	60	
Artikel-Nr.	2114/38	2114/40	2114/42	2114/45	2114/50	2114/60	
925 Silber 1 St.	•	•	•	•	•	•	•
925 Silber 10 St.	•	•	•	•	•	•	•

Erbskette Ø 1,5 mm, schwere Ausführung / dichtes Muster Pea Chain Ø 1,5 mm, heavy version	Silber:						
							
	Gold:						
							
Länge in cm ca.	38	40	42	45	50	60	
Artikel-Nr.	1615/38	1615/40	1615/42	1615/45	1615/50	1615/60	
925 Silber 1 St.	•	•	•	•	•	•	
925 Silber 10 St.	•	•	•	•	•	•	
585 GG 1 St.	•	•	•	•	•	•	
585 WG RH 1 St.	•	•	•	•	•		
750 GG 1 St.	•	•	•	•			

Erbskette Ø 1,8 mm Pea Chain Ø 1,8 mm							
	Länge in cm ca.						
	38	40	42	45	50	60	
Artikel-Nr.	1618/38	1618/40	1618/42	1618/45	1618/50	1618/60	
925 Silber 1 St.	•	•	•	•	•	•	
925 Silber 10 St.	•	•	•	•	•	•	

Erbskette Ø 1,9 mm Pea Chain Ø 1,9 mm							
	Länge in cm ca.						
	38	40	42	45	50	60	70
Artikel-Nr.	1620/38	1620/40	1620/42	1620/45	1620/50	1620/60	1620/70
925 Silber 1 St.	•	•	•	•	•	•	•
925 Silber 10 St.	•	•	•	•	•	•	•

Erbskette Ø 2,0 mm, schwere Ausführung / dichtes Muster Pea Chain Ø 2,0 mm, heavy version	Silber:						
							
	Gold:						
							
Länge in cm ca.	38	40	42	45	50	60	70
Artikel-Nr.	1621/38	1621/40	1621/42	1621/45	1621/50	1621/60	1621/70
925 Silber 1 St.	•	•	•	•	•	•	•
925 Silber 10 St.	•	•	•	•	•	•	•
585 GG 1 St.	•	•	•	•	•	•	
585 WG RH 1 St.	•	•	•	•	•		
750 GG 1 St.	•	•	•	•	•		

SUMA FURNITUREN

Mulde 10 D-75239 Eisingen • ☎ +49 (0) 7232 809 454 • 📠 +49 (0) 7232 809 453 • ✉ info@sumafurnituren.de • www.sumafurnituren.de

Erbskette Ø 2,3 mm Pea Chain Ø 2,3 mm									
Länge in cm ca.		40	42	45	50	60	70	80	90
Artikel-Nr.		1623/40	1623/42	1623/45	1623/50	1623/60	1623/70	1623/80	1623/90
925 Silber	1 St.	•	•	•	•	•	•	•	•
925 Silber	10 St.	•	•	•	•	•	•	•	•

Erbskette Ø 2,5 mm, schwere Ausführung / dichtes Muster Pea Chain Ø 2,5 mm, heavy version									
Länge in cm ca.		40	42	45	50	60	70		
Artikel-Nr.		1625/40	1625/42	1625/45	1625/50	1625/60	1625/70		
925 Silber	1 St.	•	•	•	•	•	•		
925 Silber	10 St.	•	•	•	•	•	•		

Erbskette Ø 2,7 mm Pea Chain Ø 2,7 mm									
Länge in cm ca.		40	42	45	50	60	70	80	90
Artikel-Nr.		1627/40	1627/42	1627/45	1627/50	1627/60	1627/70	1627/80	1627/90
925 Silber	1 St.	•	•	•	•	•	•	•	•
925 Silber	10 St.	•	•	•	•	•	•	•	•

Erbskette Ø 3,0 mm, schwere Ausführung / dichtes Muster Pea Chain Ø 3,0 mm, heavy version									
Länge in cm ca.		40	42	45	50	60	70		
Artikel-Nr.		1630/40	1630/42	1630/45	1630/50	1630/60	1630/70		
925 Silber	1 St.	•	•	•	•	•	•		

Erbskette Ø 3,2 mm, schwere Ausführung Pea Chain Ø 3,2 mm, heavy version									
Länge in cm ca.		40	42	45	50	60	70	80	90
Artikel-Nr.		1632/40	1632/42	1632/45	1632/50	1632/60	1632/70	1632/80	1632/90
925 Silber	1 St.	•	•	•	•	•	•	•	•
925 Silber	10 St.	•	•	•	•	•	•	•	•

Erbskette Ø 3,5 mm Pea Chain Ø 3,5 mm								
Länge in cm ca.	40	42	45	50	60	70	80	90
Artikel-Nr.	1635/40	1635/42	1635/45	1635/50	1635/60	1635/70	1635/80	1635/90
925 Silber 1 St.	•	•	•	•	•	•	•	•
925 Silber 10 St.	•	•	•	•	•	•	•	•

Erbskette Ø 4,0 mm Pea Chain Ø 4,0 mm								
Länge in cm ca.	40	42	45	50	60	70	80	90
Artikel-Nr.	1640/40	1640/42	1640/45	1640/50	1640/60	1640/70	1640/80	1640/90
925 Silber 1 St.	•	•	•	•	•	•	•	•
925 Silber 10 St.	•	•	•	•	•	•	•	•

Erbskette Ø 4,1 mm, schwere Ausführung Pea Chain Ø 4,1 mm, heavy version								
Länge in cm ca.	40	42	45	50	60	70	80	90
Artikel-Nr.	1641/40	1641/42	1641/45	1641/50	1641/60	1641/70	1641/80	1641/90
925 Silber 1 St.	•	•	•	•	•	•	•	•

Erbskette Ø 4,6 mm, schwere Ausführung Pea Chain Ø 4,6 mm, heavy version								
Länge in cm ca.	42	45	50	60	70	80	90	
Artikel-Nr.	1645/42	1645/45	1645/50	1645/60	1645/70	1645/80	1645/90	
925 Silber 1 St.	•	•	•	•	•	•	•	

Erbskette Ø 5,0 mm Pea Chain Ø 5,0 mm								
Länge in cm ca.	42	45	50	60	70	80	90	
Artikel-Nr.	1650/42	1650/45	1650/50	1650/60	1650/70	1650/80	1650/90	
925 Silber 1 St.	•	•	•	•	•	•	•	

Erbskette Ø 6,1 mm, schwere Ausführung Pea Chain Ø 6,1 mm, heavy version								
Länge in cm ca.	42	45	50	60	70	80	90	
Artikel-Nr.	1661/42	1661/45	1661/50	1661/60	1661/70	1661/80	1661/90	
925 Silber 1 St.	•	•	•	•	•	•	•	

SUMA FURNITUREN



Mulde 10 D-75239 Eisingen • ☎ +49 (0) 7232 809 454 • 📠 +49 (0) 7232 809 453 • ✉ info@sumafurnituren.de • www.sumafurnituren.de



Oval-Erbs Oval Pea Chain Kettenbreite: ca. 3,5 mm								
Länge in cm ca.	40	42	45	50	60	70	80	90
Artikel-Nr.	1109/40	1109/42	1109/45	1109/50	1109/60	1109/70	1109/80	1109/90
925 Silber 1 St.	•	•	•	•	•	•	•	•
925 Silber 10 St.	•	•	•	•	•	•	•	•



Oval-Erbs Oval Pea Chain Kettenbreite: ca. 3,5 mm								
Länge in cm ca.	19	21						
Artikel-Nr.	1109/19	1109/21						
925 Silber 1 St.	•	•						
925 Silber 10 St.	•	•						

Oval-Erbs diamantiert Oval Pea Chain with diamond-cut Kettenbreite: ca. 3,5 mm								
Länge in cm ca.	40	42	45	50	60	70	80	90
Artikel-Nr.	1109D/40	1109D/42	1109D/45	1109D/50	1109D/60	1109D/70	1109D/80	1109D/90
925 Silber 1 St.	•	•	•	•	•	•	•	•
925 Silber 10 St.	•	•	•	•	•	•	•	•

Oval-Erbs diamantiert Oval Pea Chain with diamond-cut Kettenbreite: ca. 3,5 mm								
Länge in cm ca.	19,5	21						
Artikel-Nr.	1109D/19	1109D/21						
925 Silber 1 St.	•	•						
925 Silber 10 St.	•	•						



Ankerkette rund Draht-Ø 0,25 mm Cable Chain round Wire-Ø 0,25 mm Kettenbreite: ca. 0,9 mm						
						
Länge in cm ca.	38	40	42	45	50	60
Artikel-Nr.	1725/38	1725/40	1725/42	1725/45	1725/50	1725/60
925 Silber 1 St.	•	•	•	•	•	•
925 Silber 10 St.	•	•	•	•	•	•
585 GG 1 St.	•	•	•	•	•	•
585 RotG 1 St.	•	•	•	•	•	•
585 WG RH 1 St.	•	•	•	•	•	•
750 GG 1 St.	•	•	•	•	•	•
750 RotG 1 St.	•	•	•	•	•	•
750 WG RH 1 St.	•	•	•	•	•	•

Ankerkette rund Draht-Ø 0,30 mm <i>in Gold mit Karabiner</i> Cable Chain round Wire-Ø 0,30 mm <i>in Gold with trigger clasp</i> Kettenbreite: ca. 1,1 mm	Silber: 					
	Gold: 					
Länge in cm ca.	38	40	42	45	50	60
Artikel-Nr.	1730/38	1730/40	1730/42	1730/45	1730/50	1730/60
925 Silber 1 St.	•	•	•	•	•	•
925 Silber 10 St.	•	•	•	•	•	•
585 GG 1 St.	•	•	•	•	•	•
585 RotG 1 St.	•	•	•	•	•	•
585 WG RH 1 St.	•	•	•	•	•	•
750 GG 1 St.	•	•	•	•	•	•
750 RotG 1 St.	•	•	•	•	•	•
750 WG 1 St.	•	•	•	•	•	•



Ankerkette rund Draht-Ø 0,35 mm Cable Chain round Wire-Ø 0,35 mm Kettenbreite: ca. 1,4 mm	Silber: 								
	Gold: 								
Länge in cm ca.	38	40	42	45	50	60	70	80	90
Artikel-Nr.	1735/38	1735/40	1735/42	1735/45	1735/50	1735/60	1735/70	1735/80	1735/90
925 Silber 1 St.	•	•	•	•	•	•	•	•	•
925 Silber 10 St.	•	•	•	•	•	•	•	•	•
585 GG 1 St.	•	•	•	•	•	•			
585 RotG 1 St.	•	•	•	•	•	•			
585 WG RH 1 St.	•	•	•	•	•	•			
750 GG 1 St.	•	•	•	•	•	•			
750 RotG 1 St.	•	•	•	•	•	•			
750 WG RH 1 St.	•	•	•	•	•	•			
950 Platin 1 St.			•	•	•				

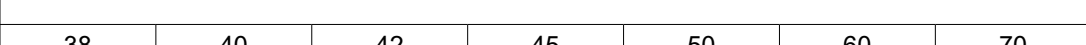

SUMA FURNITUREN

Mulde 10 D-75239 Eisingen ● ☎ +49 (0) 7232 809 454 ● 📠 +49 (0) 7232 809 453 ● ✉ info@sumafurnituren.de ● www.sumafurnituren.de

Ankerkette rund Draht-Ø 0,40 mm <i>in Gold mit Karabiner</i> Cable Chain round Wire-Ø 0,40 mm <i>in Gold with trigger clasp</i> Kettenbreite: ca. 1,6 mm	Silber:								
									
	Gold:								
									
Länge in cm ca.	38	40	42	45	50	60	70	80	90
Artikel-Nr.	1740/38	1740/40	1740/42	1740/45	1740/50	1740/60	1740/70	1740/80	1740/90
925 Silber 1 St.	•	•	•	•	•	•	•	•	•
925 Silber 10 St.	•	•	•	•	•	•	•	•	•
585 GG 1 St.	•	•	•	•	•	•			
585 RotG 1 St.	•	•	•	•	•	•			
585 WG RH 1 St.	•	•	•	•	•	•			
750 GG 1 St.	•	•	•	•	•	•			
750 RotG 1 St.	•	•	•	•	•	•			
750 WG RH 1 St.	•	•	•	•	•	•			
950 Platin 1 St.			•	•	•				

Ankerkette rund Draht-Ø 0,45 mm Cable Chain round Wire-Ø 0,45 mm Kettenbreite: ca. 1,75 mm	Silber:						
							
	Gold:						
							
Länge in cm ca.	38	40	42	45	50	60	70
Artikel-Nr.	1745/38	1745/40	1745/42	1745/45	1745/50	1745/60	1745/70
925 Silber 1 St.		•	•	•	•	•	•
925 Silber 10 St.		•	•	•	•	•	•
585 GG 1 St.	•	•	•	•	•	•	
585 RotG 1 St.	•	•	•	•	•	•	
585 WG RH 1 St.	•	•	•	•	•	•	
750 GG 1 St.	•	•	•	•	•	•	
750 RotG 1 St.	•	•	•	•	•	•	
750 WG RH 1 St.	•	•	•	•	•	•	

Ankerkette rund Draht-Ø 0,50 mm <i>in Gold mit Karabiner</i> Cable Chain round Wire-Ø 0,50 mm <i>in Gold with trigger clasp</i> Kettenbreite: ca. 1,9 mm	Silber:							
								
	Gold:							
								
Länge in cm ca.	40	42	45	50	60	70	80	90
Artikel-Nr.	1750/40	1750/42	1750/45	1750/50	1750/60	1750/70	1750/80	1750/90
925 Silber 1 St.	•	•	•	•	•	•	•	•
925 Silber 10 St.	•	•	•	•	•	•	•	•
585 GG 1 St.	•	•	•	•	•			
585 RotG 1 St.	•	•	•	•	•			
585 WG RH 1 St.	•	•	•	•	•			
750 GG 1 St.	•	•	•	•	•			
750 RotG 1 St.	•	•	•	•	•			
750 WG RH 1 St.	•	•	•	•	•			

Ankerkette rund Draht-Ø 0,60 mm Cable Chain round Wire-Ø 0,60 mm Kettenbreite: ca. 2,4 mm	Silber:							
								
	Gold:							
								
Länge in cm ca.	40	42	45	50	60	70	80	90
Artikel-Nr.	1760/40	1760/42	1760/45	1760/50	1760/60	1760/70	1760/80	1760/90
925 Silber 1 St.	•	•	•	•	•	•	•	•
925 Silber 10 St.	•	•	•	•	•	•	•	•
585 GG 1 St.	•	•	•	•	•			
750 GG 1 St.	•	•	•	•				

Ankerkette rund Draht-Ø 0,80 mm Cable Chain round Wire-Ø 0,80 mm Kettenbreite: ca. 3,0 mm								
	Länge in cm ca.	40	42	45	50	60	70	80
Artikel-Nr.	1780/40	1780/42	1780/45	1780/50	1780/60	1780/70	1780/80	1780/90
925 Silber 1 St.	•	•	•	•	•	•	•	•
925 Silber 10 St.	•	•	•	•	•	•	•	•

Ankerkette rund Draht-Ø 1,0 mm Cable Chain round Wire-Ø 1,0 mm Kettenbreite: ca. 3,9 mm								
	Länge in cm ca.	42	45	50	60	70	80	90
Artikel-Nr.	17100/42	17100/45	17100/50	17100/60	17100/70	17100/80	17100/90	
925 Silber 1 St.	•	•	•	•	•	•	•	•
925 Silber 10 St.	•	•	•	•	•	•	•	•

Ankerkette rund Draht-Ø 1,2 mm Cable Chain round Wire-Ø 1,2 mm Kettenbreite: ca. 4,6 mm								
	Länge in cm ca.	42	45	50	60	70	80	90
Artikel-Nr.	17120/42	17120/45	17120/50	17120/60	17120/70	17120/80	17120/90	
925 Silber 1 St.	•	•	•	•	•	•	•	•
925 Silber 10 St.	•	•	•	•	•	•	•	•

SUMA FURNITUREN

Mulde 10 D-75239 Eisingen • ☎ +49 (0) 7232 809 454 • 📠 +49 (0) 7232 809 453 • ✉ info@sumafurnituren.de • www.sumafurnituren.de

Weitankerkette 0,40 Wide Cable Chain 0,40 Kettenbreite: ca. 1,6 mm									
Länge in cm ca.		38	40	42	45	50	60	70	80
Artikel-Nr.		1741/38	1741/40	1741/42	1741/45	1741/50	1741/60	1741/70	1741/80
925 Silber	1 St.	•	•	•	•	•	•	•	•
925 Silber	10 St.	•	•	•	•	•	•	•	•

Weitankerkette 0,60 Wide Cable Chain 0,60 Kettenbreite: ca. 2,4 mm									
Länge in cm ca.		40	42	45	50	60	70	80	90
Artikel-Nr.		1761/40	1761/42	1761/45	1761/50	1761/60	1761/70	1761/80	1761/90
925 Silber	1 St.	•	•	•	•	•	•	•	•
925 Silber	10 St.	•	•	•	•	•	•	•	•

Weitankerkette 0,80 Wide Cable Chain 0,80 Kettenbreite: ca. 3,0 mm									
Länge in cm ca.		42	45	50	60	70	80	90	
Artikel-Nr.		1781/42	1781/45	1781/50	1781/60	1781/70	1781/80	1781/90	
925 Silber	1 St.	•	•	•	•	•	•	•	
925 Silber	10 St.	•	•	•	•	•	•	•	

Extra weite Ankerkette 0,50, rund Extra wide Cable Chain 0,50r, round Kettenbreite: ca. 2,7 mm									
Länge in cm ca.		40	42	45	50	60	70		
Artikel-Nr.		1752/40	1752/42	1752/45	1752/50	1752/60	1752/70		
925 Silber	1 St.	•	•	•	•	•	•		
925 Silber	10 St.	•	•	•	•	•	•		

Extra weite Ankerkette 0,60, rund, Extra wide Cable Chain 0,60, round Kettenbreite: ca. 3,4 mm									
Länge in cm ca.		40	42	45	50	60	70	80	90
Artikel-Nr.		1762/40	1762/42	1762/45	1762/50	1762/60	1762/70	1762/80	1762/90
925 Silber	1 St.	•	•	•	•	•	•	•	•
925 Silber	10 St.	•	•	•	•	•	•	•	•
Länge in cm ca.		17	19	21					
Artikel-Nr.		1762/17	1762/19	1762/21					
925 Silber	1 St.	•	•	•					
925 Silber	10 St.	•	•	•					

Extra weite Ankerkette 0,60 flach Extra wide Cable Chain 0,60 flat Kettenbreite: ca. 3,5 mm										
Länge in cm ca.	17	19	40	42	45	50	60	70	80	
Artikel-Nr.	1763/17	1763/19	1763/40	1763/42	1763/45	1763/50	1763/60	1763/70	1763/80	
925 Silber	1 St.	•	•	•	•	•	•	•	•	•
925 Silber	10 St.	•	•	•	•	•	•	•	•	•

Extra weite Ankerkette 0,70 rund Extra wide Cable Chain 0,70 round Kettenbreite: ca. 5,6 mm										
Länge in cm ca.	19	21	42	45	50	60	70	80	90	
Artikel-Nr.	1772/19	1772/21	1772/42	1772/45	1772/50	1772/60	1772/70	1772/80	1772/90	
925 Silber	1 St.	•	•	•	•	•	•	•	•	•
925 Silber	10 St.	•	•	•	•	•	•	•	•	•

Extra weite Ankerkette 0,70 flach Extra wide Cable Chain 0,70 flat Kettenbreite: ca. 5,7 mm										
Länge in cm ca.	19	21	42	45	50	60	70	80	90	
Artikel-Nr.	1773/19	1773/21	1773/42	1773/45	1773/50	1773/60	1773/70	1773/80	1773/90	
925 Silber	1 St.	•	•	•	•	•	•	•	•	•
925 Silber	10 St.	•	•	•	•	•	•	•	•	•

Extra weite Ankerkette 0,70 flach, eismatt Extra wide Cable Chain 0,70 flat, patterned Kettenbreite: ca. 5,7 mm										
Länge in cm ca.	19	21	42	45	50	60	70	80	90	
Artikel-Nr.	1774/19	1774/21	1774/42	1774/45	1774/50	1774/60	1774/70	1774/80	1774/90	
925 Silber	1 St.	•	•	•	•	•	•	•	•	•
925 Silber	10 St.	•	•	•	•	•	•	•	•	•

Extra weite Ankerkette 1,0 rund Extra wide Cable Chain 1,0 round Kettenbreite: ca. 4,5 mm										
Länge in cm ca.	19	21	42	45	50	60	70	80	90	
Artikel-Nr.	17102/19	17102/21	17102/42	17102/45	17102/50	17102/60	17102/70	17102/80	17102/90	
925 Silber	1 St.	•	•	•	•	•	•	•	•	•
925 Silber	10 St.	•	•	•	•	•	•	•	•	•

Diamantierte Ankerketten, mit radialem Diamantschnitt Diamond-cutted cable chain, with radial diamond cutting

Flächiger, radialer Diamantschnitt auf jeder Öse. Dadurch erhält die Kette einen besonders starken Glanz.



Ankerkette diamantiert Draht-Ø 0,35 mm Cable Chain diamond-cut, wire-Ø 0,35 mm Kettenbreite: ca. 1,3 mm							
Länge in cm ca.		38	40	42	45	50	60
Artikel-Nr.		1735MD/38	1735MD/40	1735MD/42	1735MD/45	1735MD/50	1735MD/60
925 Silber	1 St.	•	•	•	•	•	•
925 Silber	10 St.	•	•	•	•	•	•

Ankerkette diamantiert Draht-Ø 0,40 mm Cable Chain diamond-cut, wire-Ø 0,40 mm Kettenbreite: ca. 1,4 mm							
Länge in cm ca.		38	40	42	45	50	60
Artikel-Nr.		1740MD/38	1740MD/40	1740MD/42	1740MD/45	1740MD/50	1740MD/60
925 Silber	1 St.	•	•	•	•	•	•
925 Silber	10 St.	•	•	•	•	•	•

Ankerkette diamantiert Draht-Ø 0,50 mm Cable Chain diamond-cut, wire-Ø 0,50 mm Kettenbreite: ca. 2,0 mm							
Länge in cm ca.		40	42	45	50	60	
Artikel-Nr.		1750MD/40	1750MD/42	1750MD/45	1750MD/50	1750MD/60	
925 Silber	1 St.	•	•	•	•	•	
925 Silber	10 St.	•	•	•	•	•	

Ankerkette diamantiert Draht-Ø 0,50 mm Cable Chain diamond-cut, wire-Ø 0,50 mm Kettenbreite: ca. 2,2 mm							
Länge in cm ca.		40	42	45	50	60	
Artikel-Nr.		1760MD/40	1760MD/42	1760MD/45	1760MD/50	1760MD/60	
925 Silber	1 St.	•	•	•	•	•	
925 Silber	10 St.	•	•	•	•	•	

Diamantierte Ankerketten / Diamond-cutted cable chain

in Silber:
Diamantschnitt als spitze Dachform



in Gold:
Diamantschnitt, flach, auf der Öse



Ankerkette diamantiert Draht-Ø 0,30 mm Cable Chain diamond-cut, wire-Ø 0,30 mm Kettenbreite: ca. 1,2 mm						
Länge in cm ca.		38	40	42	45	50
Artikel-Nr.		1730D/38	1730D/40	1730D/42	1730D/45	1730D/50
925 Silber	1 St.	•	•	•	•	•
925 Silber	10 St.	•	•	•	•	•

Ankerkette diamantiert Draht-Ø 0,30 mm Cable Chain diamond-cut, wire-Ø 0,30 mm Kettenbreite: ca. 0,9 mm						
Länge in cm ca.		38	40	42	45	50
Artikel-Nr.		1730F/38	1730F/40	1730F/42	1730F/45	1730F/50
585 GG	1 St.	•	•	•	•	•
585 RotG	1 St.	•	•	•	•	•
585 WG RH	1 St.	•	•	•	•	•
750 GG	1 St.	•	•	•	•	•
750 RotG	1 St.	•	•	•	•	•
750 WG RH	1 St.	•	•	•	•	•

Ankerkette diamantiert Draht-Ø 0,35 mm Cable Chain diamond-cut, wire-Ø 0,35 mm Kettenbreite: ca. 1,3 mm							
Länge in cm ca.		38	40	42	45	50	60
Artikel-Nr.		1735D/38	1735D/40	1735D/42	1735D/45	1735D/50	1735D/60
925 Silber	1 St.	•	•	•	•	•	•
925 Silber	10 St.	•	•	•	•	•	•

Ankerkette diamantiert Draht-Ø 0,35 mm Cable Chain diamond-cut, wire-Ø 0,35 mm Kettenbreite: ca. 1,1 mm						
Länge in cm ca.		38	40	42	45	50
Artikel-Nr.		1735F/38	1735F/40	1735F/42	1735F/45	1735F/50
585 GG	1 St.	•	•	•	•	•
585 RotG	1 St.	•	•	•	•	•
585 WG RH	1 St.	•	•	•	•	•
750 GG	1 St.	•	•	•	•	•
750 RotG	1 St.	•	•	•	•	•
750 WG RH	1 St.	•	•	•	•	•

SUMA FURNITUREN

Mulde 10 D-75239 Eisingen • ☎ +49 (0) 7232 809 454 • 📠 +49 (0) 7232 809 453 • ✉ info@sumafurnituren.de • www.sumafurnituren.de

Ankerkette diamantiert Draht-Ø 0,40 mm Cable Chain diamond-cut, wire-Ø 0,40 mm Kettenbreite: ca. 1,5 mm									
Länge in cm ca.		38	40	42	45	50	60	70	80
Artikel-Nr.		1740D/38	1740D/40	1740D/42	1740D/45	1740D/50	1740D/60	1740D/70	1740D/80
925 Silber	1 St.	•	•	•	•	•	•	•	•
925 Silber	10 St.	•	•	•	•	•	•	•	•

Ankerkette diamantiert Draht-Ø 0,40 mm Cable Chain diamond-cut, wire-Ø 0,40 mm Kettenbreite: ca. 1,3 mm							
Länge in cm ca.		38	40	42	45	50	
Artikel-Nr.		1740F/38	1740F/40	1740F/42	1740F/45	1740F/50	
585 GG	1 St.	•	•	•	•	•	
585 RotG	1 St.	•	•	•	•	•	
585 WG RH	1 St.	•	•	•	•	•	
750 GG	1 St.	•	•	•	•	•	
750 RotG	1 St.	•	•	•	•	•	
750 WG RH	1 St.	•	•	•	•	•	

Ankerkette diamantiert Draht-Ø 0,45 mm Cable Chain diamond-cut, wire-Ø 0,45 mm Kettenbreite: ca. 1,5 mm							
Länge in cm ca.		38	40	42	45	50	
Artikel-Nr.		1745F/38	1745F/40	1745F/42	1745F/45	1745F/50	
585 GG	1 St.	•	•	•	•	•	
585 WG RH	1 St.	•	•	•	•	•	
750 GG	1 St.	•	•	•	•	•	

Ankerkette diamantiert Draht-Ø 0,50 mm Cable Chain diamond-cut, wire-Ø 0,50 mm Kettenbreite: ca. 1,9 mm								
Länge in cm ca.		40	42	45	50	60	70	80
Artikel-Nr.		1750D/40	1750D/42	1750D/45	1750D/50	1750D/60	1750D/70	1750D/80
925 Silber	1 St.	•	•	•	•	•	•	•
925 Silber	10 St.	•	•	•	•	•	•	•

Ankerkette diamantiert Draht-Ø 0,60 mm Cable Chain diamond-cut, wire-Ø 0,60 mm Kettenbreite: ca. 2,1 mm								
Länge in cm ca.		40	42	45	50	60	70	80
Artikel-Nr.		1760D/40	1760D/42	1760D/45	1760D/50	1760D/60	1760D/70	1760D/80
925 Silber	1 St.	•	•	•	•	•	•	•
925 Silber	10 St.	•	•	•	•	•	•	•

Ankerkette diamantiert Draht-Ø 0,80 mm Cable Chain diamond-cut, wire-Ø 0,80 mm Kettenbreite: ca. 2,9 mm								
Länge in cm ca.		40	42	45	50	60	70	80
Artikel-Nr.		1780D/40	1780D/42	1780D/45	1780D/50	1780D/60	1780D/70	1780D/80
925 Silber	1 St.	•	•	•	•	•	•	•
925 Silber	10 St.	•	•	•	•	•	•	•

Ankerkette diamantiert Draht-Ø 1,0 mm Cable Chain diamond-cut, wire-Ø 1,0 mm Kettenbreite: ca. 3,5 mm								
Länge in cm ca.		40	42	45	50	60	70	80
Artikel-Nr.		17100D/40	17100D/42	17100D/45	17100D/50	17100D/60	17100D/70	17100D/80
925 Silber	1 St.	•	•	•	•	•	•	•
925 Silber	10 St.	•	•	•	•	•	•	•

SUMA FURNITUREN

Mulde 10 D-75239 Eisingen ● ☎ +49 (0) 7232 809 454 ● 📠 +49 (0) 7232 809 453 ● ✉ info@sumafurnituren.de ● www.sumafurnituren.de

Venezianerkette 0,95 x 0,95 mm Venezia Chain 0,95 x 0,95 mm							
Länge in cm ca.		38	40	42	45	50	60
Artikel-Nr.		1510/38	1510/40	1510/42	1510/45	1510/50	1510/60
925 Silber	1 St.	•	•	•	•	•	•
925 Silber	10 St.	•	•	•	•	•	•
585 GG	1 St.	•	•	•	•	•	
585 WG RH	1 St.	•	•	•	•	•	
750 GG	1 St.	•	•	•	•	•	

Venezianerkette 1,25 x 1,25 mm Venezia Chain 1,25 x 1,25 mm							
Länge in cm ca.		38	40	42	45	50	60
Artikel-Nr.		1513/38	1513/40	1513/42	1513/45	1513/50	1513/60
925 Silber	1 St.	•	•	•	•	•	•
925 Silber	10 St.	•	•	•	•	•	•
585 GG	1 St.	•	•	•	•	•	
585 WG RH	1 St.	•	•	•	•	•	
750 GG	1 St.	•	•	•	•	•	

Venezianerkette 1,45 x 1,45 mm Venezia Chain 1,45 x 1,45 mm							
Länge in cm ca.		40	42	45	50	60	70
Artikel-Nr.		1515/40	1515/42	1515/45	1515/50	1515/60	1515/70
925 Silber	1 St.	•	•	•	•	•	•
925 Silber	10 St.	•	•	•	•	•	•

Venezianerkette 1,9 x 1,9 mm Venezia Chain 1,9 x 1,9 mm							
Länge in cm ca.		40	42	45	50	60	70
Artikel-Nr.		1518/40	1518/42	1518/45	1518/50	1518/60	1518/70
925 Silber	1 St.	•	•	•	•	•	•
925 Silber	10 St.	•	•	•	•	•	•

Venezianerkette 2,1 x 2,1 mm Venezia Chain 2,1 x 2,1 mm							
Länge in cm ca.		40	42	45	50	60	70
Artikel-Nr.		1520/40	1520/42	1520/45	1520/50	1520/60	1520/70
925 Silber	1 St.	•	•	•	•	•	•
925 Silber	10 St.	•	•	•	•	•	•

Venezianerkette, rund gezogen 1,6 mm Venezia Chain, round 1,6 mm						
Länge in cm ca.	40	42	45	50		
Artikel-Nr.	3116/40	3116/42	3116/45	3116/50		
925 Silber 1 St.	•	•	•	•		
925 Silber 10 St.	•	•	•	•		

Venezianerkette, rund gezogen 1,8 mm Venezia Chain, round 1,8 mm						
Länge in cm ca.	40	42	45	50		
Artikel-Nr.	3118/40	3118/42	3118/45	3118/50		
925 Silber 1 St.	•	•	•	•		
925 Silber 10 St.	•	•	•	•		

Venezianerkette, rund gezogen 2,1 mm Venezia Chain, round 2,1 mm						
Länge in cm ca.	40	42	45	50		
Artikel-Nr.	3121/40	3121/42	3121/45	3121/50		
925 Silber 1 St.	•	•	•	•		
925 Silber 10 St.	•	•	•	•		

Venezianerkette, rund gezogen 2,7 mm Venezia Chain, round 2,7 mm						
Länge in cm ca.	40	42	45	50		
Artikel-Nr.	3127/40	3127/42	3127/45	3127/50		
925 Silber 1 St.	•	•	•	•		
925 Silber 10 St.	•	•	•	•		

SUMA FURNITUREN



Mulde 10 D-75239 Eisingen • ☎ +49 (0) 7232 809 454 • 📠 +49 (0) 7232 809 453 • ✉ info@sumafurnituren.de • www.sumafurnituren.de

Fuchsschwanzkette vierkant 1,2 x 1,2 mm <i>in Gold mit Karabiner</i> Foxtail Chain square 1,2 x 1,2 mm <i>in Gold with trigger clasp</i>							
Länge in cm ca.		40	42	45	50	60	70
Artikel-Nr.		2212/40	2212/42	2212/45	2212/50	2212/60	2212/70
935 Silber	1 St.	•	•	•	•	•	•
935 Silber	10 St.	•	•	•	•	•	•
585 GG	1 St.	•	•	•	•		
750 GG	1 St.	•	•	•	•		

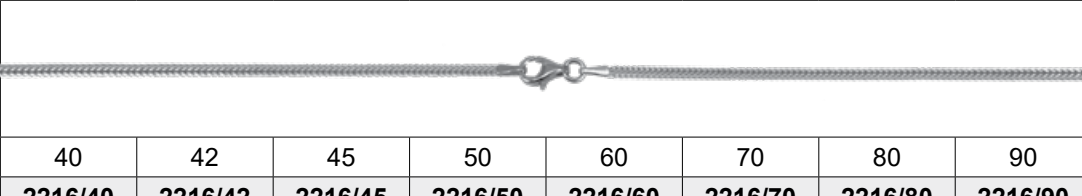

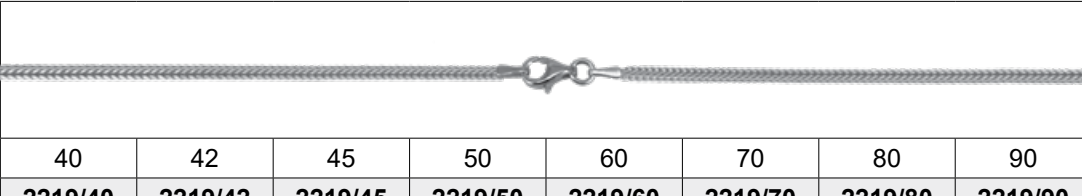
Fuchsschwanzkette vierkant 1,3 x 1,3 mm <i>in Gold mit Karabiner</i> Foxtail Chain square 1,3 x 1,3 mm <i>in Gold with trigger clasp</i>									
Länge in cm ca.		40	42	45	50	60	70	80	90
Artikel-Nr.		2213/40	2213/42	2213/45	2213/50	2213/60	2213/70	2213/80	2213/90
935 Silber	1 St.	•	•	•	•	•	•	•	•
935 Silber	10 St.	•	•	•	•	•	•	•	•
585 GG	1 St.	•	•	•	•	•			
750 GG	1 St.	•	•	•	•	•			

Fuchsschwanzkette vierkant 1,6 x 1,6 mm Foxtail Chain square 1,6 x 1,6 mm									
Länge in cm ca.		40	42	45	50	60	70	80	90
Artikel-Nr.		2216/40	2216/42	2216/45	2216/50	2216/60	2216/70	2216/80	2216/90
935 Silber	1 St.	•	•	•	•	•	•	•	•
935 Silber	10 St.	•	•	•	•	•	•	•	•
585 GG	1 St.	•	•	•	•	•			

Fuchsschwanzkette vierkant 1,9 x 1,9 mm Foxtail Chain square 1,9 x 1,9 mm									
Länge in cm ca.		40	42	45	50	60	70	80	90
Artikel-Nr.		2219/40	2219/42	2219/45	2219/50	2219/60	2219/70	2219/80	2219/90
935 Silber	1 St.	•	•	•	•	•	•	•	•
935 Silber	10 St.	•	•	•	•	•	•	•	•

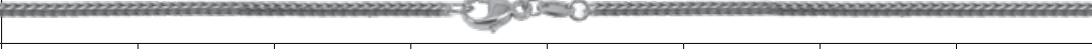
Fuchsschwanzkette rund gezogen 1,0 mm Foxtail Chain drawn round 1,0 mm ●-Profil	Silber:							
								
	Gold:							
								
Länge in cm ca.	40	42	45	50	60	70	80	90
Artikel-Nr.	2210R/40	2210R/42	2210R/45	2210R/50	2210R/60	2210R/70	2210R/80	2210R/90
935 Silber 1 St.	●	●	●	●	●	●	●	●
935 Silber 10 St.	●	●	●	●	●	●	●	●
585 GG 1 St.	●	●	●	●	●			
585 WG 1 St.		●						
750 GG 1 St.	●	●	●	●	●			

Fuchsschwanzkette rund gezogen 1,3 mm Foxtail Chain drawn round 1,3 mm ●-Profil	Silber:							
								
	Gold:							
								
Länge in cm ca.	40	42	45	50	60	70	80	90
Artikel-Nr.	2213R/40	2213R/42	2213R/45	2213R/50	2213R/60	2213R/70	2213R/80	2213R/90
935 Silber 1 St.	●	●	●	●	●	●	●	●
935 Silber 10 St.	●	●	●	●	●	●	●	●
585 GG 1 St.	●	●	●	●	●			
750 GG 1 St.	●	●	●	●	●			

Fuchsschwanzkette rund gezogen 1,5 mm Foxtail Chain drawn round 1,5 mm ●-Profil	Silber:							
								
	Gold:							
								
Länge in cm ca.	40	42	45	50	60	70	80	90
Artikel-Nr.	2215R/40	2215R/42	2215R/45	2215R/50	2215R/60	2215R/70	2215R/80	2215R/90
935 Silber 1 St.	●	●	●	●	●	●	●	●
935 Silber 10 St.	●	●	●	●	●	●	●	●
585 GG 1 St.	●	●	●	●				



Fuchsschwanzkette rund gezogen 1,7 mm Foxtail Chain drawn round 1,7 mm ●-Profil	Silber:							
								
Länge in cm ca.	40	42	45	50	60	70	80	90
Artikel-Nr.	2217R/40	2217R/42	2217R/45	2217R/50	2217R/60	2217R/70	2217R/80	2217R/90
935 Silber 1 St.	●	●	●	●	●	●	●	●
935 Silber 10 St.	●	●	●	●	●	●	●	●



SUMA FURNITUREN

Mulde 10 D-75239 Eisingen • ☎ +49 (0) 7232 809 454 • 📠 +49 (0) 7232 809 453 • ✉ info@sumafurnituren.de • www.sumafurnituren.de

Fuchsschwanzkette rund gezogen 1,9 mm Foxtail Chain drawn round 1,9 mm ●-Profil									
Länge in cm ca.		40	42	45	50	60	70	80	90
Artikel-Nr.		2219R/40	2219R/42	2219R/45	2219R/50	2219R/60	2219R/70	2219R/80	2219R/90
935 Silber	1 St.	•	•	•	•	•	•	•	•
935 Silber	10 St.	•	•	•	•	•	•	•	•

Fuchsschwanzkette rund gezogen 2,5 mm Foxtail Chain drawn round 2,5 mm ●-Profil									
Länge in cm ca.		40	42	45	50	60	70	80	90
Artikel-Nr.		2225R/40	2225R/42	2225R/45	2225R/50	2225R/60	2225R/70	2225R/80	2225R/90
935 Silber	1 St.	•	•	•	•	•	•	•	•
935 Silber	10 St.	•	•	•	•	•	•	•	•



Kugelkette rund 1,2 mm Ball Chain round 1,2 mm	Silber:							
								
	Gold:							
								
Länge in cm ca.	40	42	45	50	60	70	80	90
Artikel-Nr.	1012/40	1012/42	1012/45	1012/50	1012/60	1012/70	1012/80	1012/90
925 Silber 1 St.	•	•	•	•	•	•	•	•
925 Silber 10 St.	•	•	•	•	•	•	•	•
585 GG 1 St.	•	•	•	•	•			
585 RotG 1 St.	•	•	•	•	•			
585 WG 1 St.	•	•	•	•	•			
750 GG 1 St.	•	•	•	•	•			
750 RotG 1 St.	•	•	•	•	•			
750 WG 1 St.	•	•	•	•	•			

Kugelkette rund 1,5 mm Ball Chain round 1,5 mm	Silber:							
								
	Gold:							
								
Länge in cm ca.	40	42	45	50	60	70	80	90
Artikel-Nr.	1015/40	1015/42	1015/45	1015/50	1015/60	1015/70	1015/80	1015/90
925 Silber 1 St.	•	•	•	•	•	•	•	•
925 Silber 10 St.	•	•	•	•	•	•	•	•
585 GG 1 St.	•	•	•	•	•			
585 RotG 1 St.	•	•	•	•	•			
585 WG 1 St.	•	•	•	•	•			
750 GG 1 St.	•	•	•	•	•			
750 RotG 1 St.	•	•	•	•	•			
750 WG 1 St.	•	•	•	•	•			

Kugelkette rund 1,8 mm Ball Chain round 1,8 mm								
Länge in cm ca.	40	42	45	50	60	70	80	90
Artikel-Nr.	1018/40	1018/42	1018/45	1018/50	1018/60	1018/70	1018/80	1018/90
925 Silber 1 St.	•	•	•	•	•	•	•	•
925 Silber 10 St.	•	•	•	•	•	•	•	•

SUMA FURNITUREN

Mulde 10 D-75239 Eisingen ● ☎ +49 (0) 7232 809 454 ● 📠 +49 (0) 7232 809 453 ● ✉ info@sumafurnituren.de ● www.sumafurnituren.de

Kugelmkette rund 2,0 mm Ball Chain round 2,0 mm	Silber:							
								
	Gold:							
								
Länge in cm ca.	40	42	45	50	60	70	80	90
Artikel-Nr.	1020/40	1020/42	1020/45	1020/50	1020/60	1020/70	1020/80	1020/90
925 Silber 1 St.	•	•	•	•	•	•	•	•
925 Silber 10 St.	•	•	•	•	•	•	•	•

Kugelmkette rund 2,2 mm Ball Chain round 2,2 mm								
Länge in cm ca.	40	42	45	50	60	70	80	90
Artikel-Nr.	1022/40	1022/42	1022/45	1022/50	1022/60	1022/70	1022/80	1022/90
925 Silber 1 St.	•	•	•	•	•	•	•	•
925 Silber 10 St.	•	•	•	•	•	•	•	•

Kugelmkette rund 2,5 mm Ball Chain round 2,5 mm								
Länge in cm ca.	40	42	45	50	60	70	80	90
Artikel-Nr.	1025/40	1025/42	1025/45	1025/50	1025/60	1025/70	1025/80	1025/90
925 Silber 1 St.	•	•	•	•	•	•	•	•
925 Silber 10 St.	•	•	•	•	•	•	•	•

Kugelmkette rund 3,0 mm Ball Chain round 3,0 mm									
Länge in cm ca.	19	21	42	45	50	60	70	80	90
Artikel-Nr.	1030/19	1030/21	1030/42	1030/45	1030/50	1030/60	1030/70	1030/80	1030/90
925 Silber 1 St.	•	•	•	•	•	•	•	•	•
925 Silber 10 St.	•	•	•	•	•	•	•	•	•

Kugelmkette rund 4,0 mm Ball Chain round 4,0 mm									
Länge in cm ca.	19	21	42	45	50	60	70	80	90
Artikel-Nr.	1040/19	1040/21	1040/42	1040/45	1040/50	1040/60	1040/70	1040/80	1040/90
925 Silber 1 St.	•	•	•	•	•	•	•	•	•

Kugelmkette rund 4,5 mm Ball Chain round 4,5 mm									
Länge in cm ca.	19	21	42	45	50	60	70	80	90
Artikel-Nr.	1045/19	1045/21	1045/42	1045/45	1045/50	1045/60	1045/70	1045/80	1045/90
925 Silber 1 St.	•	•	•	•	•	•	•	•	•

Kugelkette rund diamantiert 1,2 mm Ball Chain round with diamond cut 1,2 mm								
Länge in cm ca.	38	40	42	45	50	60	70	80
Artikel-Nr.	1012D/38	1012D/40	1012D/42	1012D/45	1012D/50	1012D/60	1012D/70	1012D/80
925 Silber 1 St.	•	•	•	•	•	•	•	•
925 Silber 10 St.	•	•	•	•	•	•	•	•



Kugelkette rund diamantiert 1,5 mm Ball Chain round with diamond cut 1,5 mm								
Länge in cm ca.	40	42	45	50	60	70	80	90
Artikel-Nr.	1015D/40	1015D/42	1015D/45	1015D/50	1015D/60	1015D/70	1015D/80	1015D/90
925 Silber 1 St.	•	•	•	•	•	•	•	•
925 Silber 10 St.	•	•	•	•	•	•	•	•



Kugelkette rund diamantiert 1,8 mm Ball Chain round with diamond cut 1,8 mm								
Länge in cm ca.	40	42	45	50	60	70	80	90
Artikel-Nr.	1018D/40	1018D/42	1018D/45	1018D/50	1018D/60	1018D/70	1018D/80	1018D/90
925 Silber 1 St.	•	•	•	•	•	•	•	•
925 Silber 10 St.	•	•	•	•	•	•	•	•

Kugelkette rund diamantiert 2,0 mm Ball Chain round with diamond cut 2,0 mm								
Länge in cm ca.	40	42	45	50	60	70	80	90
Artikel-Nr.	1020D/40	1020D/42	1020D/45	1020D/50	1020D/60	1020D/70	1020D/80	1020D/90
925 Silber 1 St.	•	•	•	•	•	•	•	•
925 Silber 10 St.	•	•	•	•	•	•	•	•

SUMA FURNITUREN



Mulde 10 D-75239 Eisingen • ☎ +49 (0) 7232 809 454 • 📠 +49 (0) 7232 809 453 • ✉ info@sumafurnituren.de • www.sumafurnituren.de

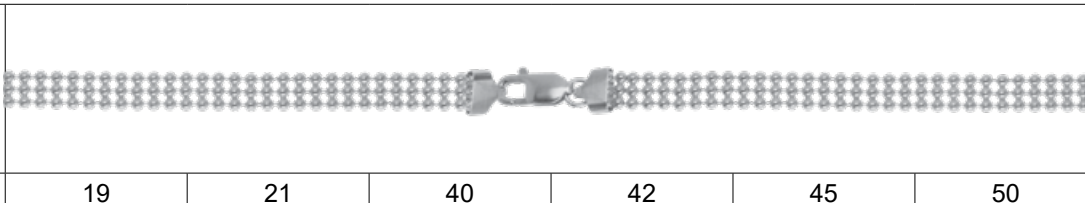

Doppelreihige Kugellkette, rund, Kugel-Ø 1,5 mm, Gesamtbreite 3,0 mm  Zweireihig						
	Länge in cm ca.	19	21	40	42	45
Artikel-Nr.	2415/19	2415/21	2415/40	2415/42	2415/45	2415/50
925 Silber 1 St.	•	•	•	•	•	•

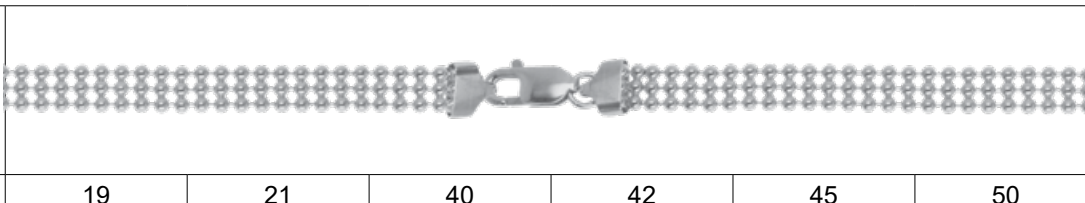

Doppelreihige Kugellkette, rund, Kugel-Ø 2,0 mm, Gesamtbreite 4,0 mm  Zweireihig						
	Länge in cm ca.	19	21	40	42	45
Artikel-Nr.	2420/19	2420/21	2420/40	2420/42	2420/45	2420/50
925 Silber 1 St.	•	•	•	•	•	•

Dreireihige Kugellkette, rund, Kugel-Ø 1,5 mm, Gesamtbreite 4,5 mm  Dreireihig						
	Länge in cm ca.	19	21	40	42	45
Artikel-Nr.	2515/19	2515/21	2515/40	2515/42	2515/45	2515/50
925 Silber 1 St.	•	•	•	•	•	•

Dreireihige Kugellkette, rund, Kugel-Ø 2,0 mm, Gesamtbreite 6,0 mm  Dreireihig						
	Länge in cm ca.	19	21	40	42	45
Artikel-Nr.	2520/19	2520/21	2520/40	2520/42	2520/45	2520/50
925 Silber 1 St.	•	•	•	•	•	•



Vierreihige Kugelkette, quadratisch, Kugel-Ø 1,0 mm, Gesamtbreite 2,0 mm 						
	Länge in cm ca.	40	42	45	50	
Artikel-Nr.	4710/40	4710/42	4710/45	4710/50		
925 Silber 1 St.	•	•	•	•		



Vierreihige Kugelkette, quadratisch, Kugel-Ø 1,2 mm, Gesamtbreite 2,4 mm 						
	Länge in cm ca.	40	42	45	50	
Artikel-Nr.	4712/40	4712/42	4712/45	4712/50		
925 Silber 1 St.	•	•	•	•		



Vierreihige Kugelkette, quadratisch, Kugel-Ø 1,5 mm, Gesamtbreite 3,0 mm 						
	Länge in cm ca.	40	42	45	50	
Artikel-Nr.	4715/40	4715/42	4715/45	4715/50		
925 Silber 1 St.	•	•	•	•		



SUMA FURNITUREN



Mulde 10 D-75239 Eisingen • ☎ +49 (0) 7232 809 454 • 📠 +49 (0) 7232 809 453 • ✉ info@sumafurnituren.de • www.sumafurnituren.de

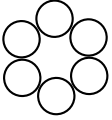

Vierreihige Kugelkette, quadratisch, diamant- tiert, Kugel-Ø 1,0 mm, Gesamtbreite 2,0 mm 						
	Länge in cm ca.	40	42	45	50	
Artikel-Nr.	4710D/40	4710D/42	4710D/45	4710D/50		
925 Silber 1 St.	•	•	•	•		

Vierreihige Kugelkette, quadratisch, diamant- tiert, Kugel-Ø 1,2 mm, Gesamtbreite 2,4 mm 						
	Länge in cm ca.	40	42	45	50	
Artikel-Nr.	4712D/40	4712D/42	4712D/45	4712D/50		
925 Silber 1 St.	•	•	•	•		

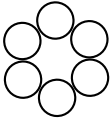
Vierreihige Kugelkette, quadratisch, diamant- tiert, Kugel-Ø 1,5 mm, Gesamtbreite 3,0 mm 						
	Länge in cm ca.	40	42	45	50	
Artikel-Nr.	4715D/40	4715D/42	4715D/45	4715D/50		
925 Silber 1 St.	•	•	•	•		

Sechsstufige Kugellampe, rund, Kugel-Ø 1,0 mm, Gesamtbreite 3,0 mm 						
Artikel-Nr.	4810/40	4810/42	4810/45	4810/50		
925 Silber 1 St.	•	•	•	•		

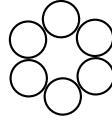
Sechsstufige Kugellampe, rund, Kugel-Ø 1,2 mm, Gesamtbreite 3,6 mm 						
Artikel-Nr.	4812/40	4812/42	4812/45	4812/50		
925 Silber 1 St.	•	•	•	•		

Sechsstufige Kugellampe, rund, Kugel-Ø 1,5 mm, Gesamtbreite 4,5 mm 						
Artikel-Nr.	4815/40	4815/42	4815/45	4815/50		
925 Silber 1 St.	•	•	•	•		

SUMA FURNITUREN

Mulde 10 D-75239 Eisingen • ☎ +49 (0) 7232 809 454 • 📠 +49 (0) 7232 809 453 • ✉ info@sumafurnituren.de • www.sumafurnituren.de

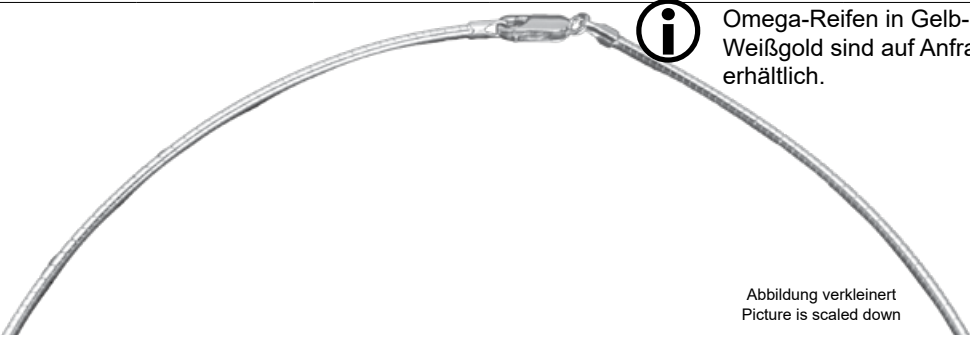
Omega-Reifen mit Karabinerverschluss Omega necklaces, with claw						
Länge in cm ca.	40	42	45	50		
Artikel-Nr.	2311/40	2311/42	2311/45	2311/50		
585 GG 1 St.	•	•	•	•		
585 WG 1 St.	•	•	•	•		
750 GG 1 St.	•	•	•	•		

Ø 1,3 mm						
Länge in cm ca.	40	42	45	50		
Artikel-Nr.	2313/40	2313/42	2313/45	2313/50		
925 Silber 1 St.	•	•	•	•		
925 Silber 10 St.	•	•	•	•		
925 Silber GGP 03 1 St.	•	•	•	•		
925 Silber RH 1 St.	•	•	•	•		

Ø 1,4 mm						
Länge in cm ca.	40	42	45	50		
Artikel-Nr.	2314/40	2314/42	2314/45	2314/50		
585 GG 1 St.	•	•	•	•		
585 WG 1 St.	•	•	•	•		
750 GG 1 St.	•	•	•	•		

Ø 1,5 mm						
Länge in cm ca.	40	42	45	50		
Artikel-Nr.	2315/40	2315/42	2315/45	2315/50		
925 Silber 1 St.	•	•	•	•		
925 Silber 10 St.	•	•	•	•		
925 Silber GGP 03 1 St.	•	•	•	•		
925 Silber RH 1 St.	•	•	•	•		

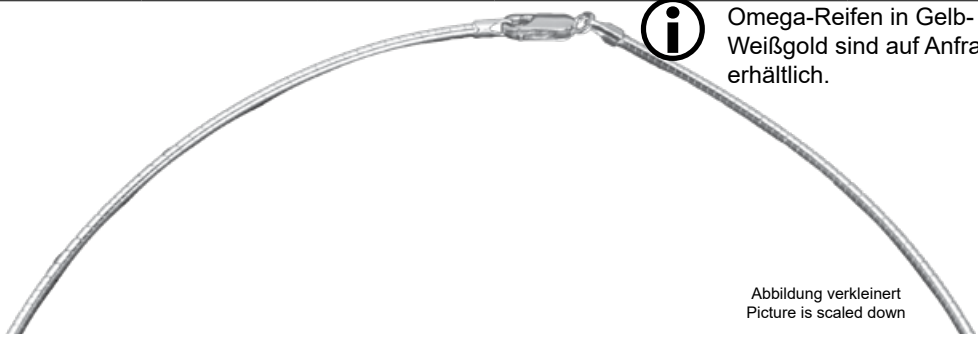
Omega-Reifen mit Karabinerverschluss Omega necklaces, with claw	 <p>Abbildung verkleinert Picture is scaled down</p>					
Ø 1,8 mm						
Länge in cm ca.	40	42	45	50		
Artikel-Nr.	2318/40	2318/42	2318/45	2318/50		
925 Silber 1 St.	•	•	•	•		
925 Silber GGP 03 1 St.	•	•	•	•		
925 Silber RH 1 St.	•	•	•	•		

Ø 1,8 mm						
Länge in cm ca.		42	45			
Artikel-Nr.		2318/42	2318/45			
585 GG 1 St.		•	•			

Ø 2,0 mm						
Länge in cm ca.	40	42	45	50		
Artikel-Nr.	2320/40	2320/42	2320/45	2320/50		
925 Silber 1 St.	•	•	•	•		
925 Silber GGP 03 1 St.	•	•	•	•		
925 Silber RH 1 St.	•	•	•	•		

Ø 2,3 mm						
Länge in cm ca.	40	42	45	50		
Artikel-Nr.	2323/40	2323/42	2323/45	2323/50		
925 Silber 1 St.	•	•	•	•		
925 Silber GGP 03 1 St.	•	•	•	•		
925 Silber RH 1 St.	•	•	•	•		

Ø 3,0 mm						
Länge in cm ca.	40	42	45	50		
Artikel-Nr.	2330/40	2330/42	2330/45	2330/50		
925 Silber 1 St.	•	•	•	•		
925 Silber GGP 03 1 St.	•	•	•	•		
925 Silber RH 1 St.	•	•	•	•		

SUMA FURNITUREN

Mulde 10 D-75239 Eisingen • ☎ +49 (0) 7232 809 454 • 📠 +49 (0) 7232 809 453 • ✉ info@sumafurnituren.de • www.sumafurnituren.de

Venezianer-Schlauchketten, rund, Ø 2,8 mm, mit Karabiner Mesh chain, round, Ø 2,8 mm, with claw				
Länge in cm ca.	40	42	45	50
Artikel-Nr.	4128/40	4128/42	4128/45	4128/50
925 Silber 1 St.	•	•	•	•

Venezianer-Schlauchketten, rund, Ø 4,0 mm, mit Karabiner Mesh chain, round, Ø 4,0 mm, with claw				
Länge in cm ca.	40	42	45	50
Artikel-Nr.	4140/40	4140/42	4140/45	4140/50
925 Silber 1 St.	•	•	•	•

Venezianer-Schlauchketten, rund, Ø 6,0 mm, mit Karabiner Mesh chain, round, Ø 6,0 mm, with claw				
Länge in cm ca.	40	42	45	50
Artikel-Nr.	4160/40	4160/42	4160/45	4160/50
925 Silber 1 St.	•	•	•	•

Venezianer-Schlauchketten, rund, Ø 3,0 mm, mit Karabiner Mesh chain, round, Ø 3,0 mm, with claw				
Länge in cm ca.	40	42	45	50
Artikel-Nr.	4230/40	4230/42	4230/45	4230/50
925 Silber 1 St.	•	•	•	•

Venezianer-Schlauchketten, rund, Ø 4,0 mm, mit Karabiner Mesh chain, round, Ø 4,0 mm, with claw				
Länge in cm ca.	40	42	45	50
Artikel-Nr.	4240/40	4240/42	4240/45	4240/50
925 Silber 1 St.	•	•	•	•

Venezianer-Schlauchketten, rund, Ø 4,5 mm, mit Karabiner Mesh chain, round, Ø 4,5 mm, with claw				
Länge in cm ca.	40	42	45	50
Artikel-Nr.	4245/40	4245/42	4245/45	4245/50
925 Silber 1 St.	•	•	•	•

Venezianer-Schlauchketten, rund, Ø 6,0 mm, mit Karabiner Mesh chain, round, Ø 6,0 mm, with claw				
Länge in cm ca.	40	42	45	50
Artikel-Nr.	4260/40	4260/42	4260/45	4260/50
925 Silber 1 St.	•	•	•	•

Venezianer-Schlauchketten, rund, Ø 7,0 mm, mit Karabiner Mesh chain, round, Ø 7,0 mm, with claw				
Länge in cm ca.	40	42	45	50
Artikel-Nr.	4270/40	4270/42	4270/45	4270/50
925 Silber 1 St.	•	•	•	•

Venezianer-Schlauchketten, diamantiert, Ø 3,0 mm, mit Karabiner Mesh chain, with diamond-cut, Ø 3,0 mm, with claw				
Länge in cm ca.	40	42	45	50
Artikel-Nr.	4230D/40	4230D/42	4230D/45	4230D/50
925 Silber 1 St.	•	•	•	•

Venezianer-Schlauchketten, rund, Ø 3,0 mm Mesh chain, round, Ø 3,0 mm				
Länge in cm ca.	40	42	45	50
Artikel-Nr.	4330/40	4330/42	4330/45	4330/50
925 Silber 1 St.	•	•	•	•

Venezianer-Schlauchketten, rund, Ø 4,0 mm Mesh chain, round, Ø 4,0 mm				
Länge in cm ca.	40	42	45	50
Artikel-Nr.	4340/40	4340/42	4340/45	4340/50
925 Silber 1 St.	•	•	•	•

SUMA FURNITUREN

Mulde 10 D-75239 Eisingen • ☎ +49 (0) 7232 809 454 • 📠 +49 (0) 7232 809 453 • ✉ info@sumafurnituren.de • www.sumafurnituren.de







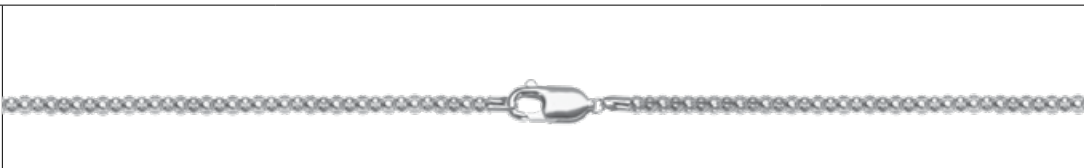

Venezianer-Schlauchketten, rund, Ø 1,6 mm, mit Karabiner Mesh chain, round, Ø 1,6 mm, with claw				
Länge in cm ca.	40	42	45	50
Artikel-Nr.	4416/40	4416/42	4416/45	4416/50
925 Silber 1 St.	•	•	•	•







Venezianer-Schlauchketten, rund, Ø 1,8 mm, mit Karabiner Mesh chain, round, Ø 1,8 mm, with claw				
Länge in cm ca.	40	42	45	50
Artikel-Nr.	4418/40	4418/42	4418/45	4418/50
925 Silber 1 St.	•	•	•	•

Venezianer-Schlauchketten, rund, Ø 2,0 mm, mit Karabiner Mesh chain, round, Ø 2,0 mm, with claw				
Länge in cm ca.	40	42	45	50
Artikel-Nr.	4420/40	4420/42	4420/45	4420/50
925 Silber 1 St.	•	•	•	•

Venezianer-Schlauchketten, rund, Ø 2,5 mm, mit Karabiner Mesh chain, round, Ø 2,5 mm, with claw				
Länge in cm ca.	40	42	45	50
Artikel-Nr.	4425/40	4425/42	4425/45	4425/50
925 Silber 1 St.	•	•	•	•





Venezianer-Schlauchketten, rund, Ø 3,0 mm, mit Karabiner Mesh chain, round, Ø 3,0 mm, with claw				
Länge in cm ca.	40	42	45	50
Artikel-Nr.	4430/40	4430/42	4430/45	4430/50
925 Silber 1 St.	•	•	•	•

Panzerkette 2-seitig diamantiert, Meterware Curb Chain 2-sides dia- mond cutted, by meter <i>Abgeschnittene Kettenstücke können weder umgetauscht noch zurückgenommen werden!!</i>									
	Drahtstärke in mm ca.	0,30	0,35	0,40	0,45	0,50	0,60	0,80	1,0
Gesamtbreite in mm ca.	1,1	1,3	1,4	1,6	1,8	2,2	2,7	3,3	4,2
Artikel-Nr.	13030	13035	13040	13045	13050	13060	13080	13100	13120
925 Silber 10 cm	•	•	•	•	•	•	•	•	•
925 Silber 100 cm	•	•	•	•	•	•	•	•	•
925 Silber 500 cm	•	•	•	•	•	•	•	•	•
925 Silber 1000 cm	•	•	•	•	•	•			
333 GG 1 cm		•	•	•	•				
333 GG 10 cm		•	•	•	•				
333 GG 100 cm		•	•	•	•				
585 GG 1 cm	•	•	•	•	•	•			
585 GG 10 cm	•	•	•	•	•	•			
585 GG 100 cm	•	•	•	•	•				
585 WG 1 cm		•	•						
585 WG 10 cm		•	•						
585 WG 100 cm		•	•						
750 GG 1 cm	•	•	•	•	•	•			
750 GG 10 cm	•	•	•	•	•	•			
750 GG 100 cm	•	•	•	•					





Panzerkette 4-seitig diamantiert, Meterware Curb Chain 4-sides dia- mond cutted, by meter <i>Abgeschnittene Kettenstücke können weder umgetauscht noch zurückgenommen werden!!</i>							
	Drahtstärke in mm ca.	1,5	1,8	2,0	2,2	2,5	3,0
Gesamtbreite in mm ca.	4,8	5,2	6,2	7,0	7,9	9,5	10,5
Artikel-Nr.	13150	13180	13200	13220	13250	13300	13350
925 Silber 10 cm	•	•	•	•	•	•	•
925 Silber 100 cm	•	•	•	•	•	•	•
925 Silber 500 cm	•	•	•	•			



SUMA FURNITUREN

Mulde 10 D-75239 Eisingen • ☎ +49 (0) 7232 809 454 • 📠 +49 (0) 7232 809 453 • ✉ info@sumafurnituren.de • www.sumafurnituren.de

<p>Panzerkette 6-seitig diamantiert, Meterware Curb Chain 6-sides dia- mond cutted, by meter</p> <p><i>Abgeschnittene Kettenstücke können weder umgetauscht noch zurückgenommen werden!!</i></p>							
	Drahtstärke in mm ca.	2,2	2,5	3,0	3,5	3,5	
	Gesamtbreite in mm ca.	8,1	9,3	11,4	13,4	13,4	
	Kettenhöhe in mm ca.				3,7	4,5	
	Artikel-Nr.	19220	19250	19300	19350	19350H	
	925 Silber 10 cm	•	•	•	•	•	
925 Silber 100 cm	•	•	•	•	•		

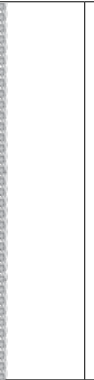





<p>Panzerkette weit, läng- liche Form, diamantiert, Meterware Curb Chain wide, 2-sides diamond cutted, by meter</p> <p><i>Abgeschnittene Kettenstücke können weder umgetauscht noch zurückgenommen werden!!</i></p>						
	Drahtstärke in mm ca.	1,0				
	Gesamtbreite in mm ca.	3,5				
	Länge Kettenglied in mm ca.	8,7				
	Artikel-Nr.	43100				
	925 Silber 10 cm	•				
925 Silber 100 cm	•					
925 Silber 500 cm	•					



Panzerkette rund Meterware Curb Chain round, by meter <i>Abgeschnittene Kettenstücke können weder umgetauscht noch zurückgenommen werden!!</i>							
	Drahtstärke in mm ca.	0,35	0,40	0,50	0,60	0,80	1,0
	Gesamtbreite in mm ca.	1,2	1,4	1,8	2,2	2,8	3,4
	Artikel-Nr.	13035R	13040R	13050R	13060R	13080R	13100R
	925 Silber 10 cm	●	●	●	●	●	●
	925 Silber 100 cm	●	●	●	●	●	●
	925 Silber 500 cm	●	●	●	●	●	●
925 Silber 1000 cm	●	●	●	●	●	●	







Panzerkette rund Meterware Curb Chain round, by meter <i>Abgeschnittene Kettenstücke können weder umgetauscht noch zurückgenommen werden!!</i>						
	Drahtstärke in mm ca.	1,2	1,5			
	Gesamtbreite in mm ca.	4,3	5,3			
	Artikel-Nr.	13120R	13150R			
	925 Silber 10 cm	●	●			
	925 Silber 100 cm	●	●			
	925 Silber 500 cm	●	●			





SUMA FURNITUREN

Mulde 10 D-75239 Eisingen ● ☎ +49 (0) 7232 809 454 ● 📠 +49 (0) 7232 809 453 ● ✉ info@sumafurnituren.de ● www.sumafurnituren.de

Figaro-Panzerkette, Meterware Figaro Chain, by meter <i>Abgeschnittene Kettenstücke können weder umgetauscht noch zurückgenommen werden!!</i>						
	Drahtstärke in mm ca.	0,40	0,40	0,50	0,50	0,60
Gesamtbreite in mm ca.	1,8	1,3	2,0	1,7	2,2	2,0
Artikel-Nr.	13640	13640	13650	13650	13660	13660
925 Silber 10 cm	•		•		•	
925 Silber 100 cm	•		•		•	
925 Silber 500 cm	•		•		•	
925 Silber 1000 cm	•		•		•	
585 GG 1 cm		•		•		•
585 GG 10 cm		•		•		•
585 GG 100 cm		•		•		•
750 GG 1 cm		•				
750 GG 10 cm		•				
750 GG 100 cm		•				

Figaro-Panzerkette, Meterware Figaro Chain, by meter <i>Abgeschnittene Kettenstücke können weder umgetauscht noch zurückgenommen werden!!</i>						
	Drahtstärke in mm ca.	0,80	1,0			
Gesamtbreite in mm ca.	2,8	3,7				
Artikel-Nr.	13680	13610				
925 Silber 10 cm	•	•				
925 Silber 100 cm	•	•				
925 Silber 500 cm	•	•				
925 Silber 1000 cm	•	•				

<p>Rundkette, Echte Schlangenkette, rund, Meterware Snake Chain, Real snake chain, round, by meter</p> <p><i>Abgeschnittene Kettenstücke können weder umgetauscht noch zurückgenommen werden!!</i></p>						
	Echte Schlan- genkette	Rundkette Round chain	Echte Schlangenkette Real Snake Chain			
Ø in mm ca.	0,9	1,0	1,2	1,4	1,6	1,9
Artikel-Nr.	1409	1410	1412	1414	1416	1419
925 Silber 10 cm		•	•	•	•	•
925 Silber 100 cm		•	•	•	•	•
925 Silber 500 cm		•	•	•	•	•
925 Silber 1000 cm		•	•	•	•	•
585 GG 1 cm	•		•	•	•	•
585 GG 10 cm	•		•	•	•	•
585 GG 100 cm	•		•	•	•	•
585 WG 1 cm	•		•	•	•	
585 WG 10 cm	•		•	•	•	
585 WG 100 cm	•		•	•	•	
750 GG 1 cm	•		•	•	•	•
750 GG 10 cm	•		•	•	•	•
750 WG 1 cm	•		•	•		
750 WG 10 cm	•		•	•		





<p>Echte Schlangenkette, rund / quadratisch, Meterware Real snake chain, round / quadratical, by meter</p> <p><i>Abgeschnittene Kettenstücke können weder umgetauscht noch zurückgenommen werden!!</i></p>						
Ø in mm ca.	2,4	3,0	4,0	5,0	1,4 x 1,4	
Artikel-Nr.	1424	1430	1440	1450	2114	
925 Silber 10 cm	•	•	•	•	•	
925 Silber 100 cm	•	•	•	•	•	
925 Silber 500 cm	•	•	•	•	•	
925 Silber 1000 cm	•	•	•	•	•	



SUMA FURNITUREN

Mulde 10 D-75239 Eisingen ● ☎ +49 (0) 7232 809 454 ● 📠 +49 (0) 7232 809 453 ● ✉ info@sumafurnituren.de ● www.sumafurnituren.de

Venezianerkette, Meterware Venezia Chain, by meter <i>Abgeschnittene Kettenstücke können weder umgetauscht noch zurückgenommen werden!!</i>								
	Abmessungen in mm ca.	0,95 x 0,95	1,15 x 1,15	1,25 x 1,25	1,45 x 1,45	1,9 x 1,9	2,1 x 2,1	2,4 x 2,4
Artikel-Nr.	1510	1512	1513	1515	1518	1520	1524	1537
925 Silber 10 cm	●	●	●	●	●	●	●	●
925 Silber 100 cm	●	●	●	●	●	●	●	●
925 Silber 500 cm	●	●	●	●	●	●	●	
925 Silber 1000 cm	●	●	●	●	●	●		









Venezianerkette, Meterware Venezia Chain, by meter <i>Abgeschnittene Kettenstücke können weder umgetauscht noch zurückgenommen werden!!</i>						
	Abmessungen in mm ca.	1,0 x 1,0	1,2 x 1,2	1,4 x 1,4	1,5 x 1,5	
Artikel-Nr.	1510	1513	1514	1515		
333 GG 1 cm	●	●				
333 GG 10 cm	●	●				
333 GG 100 cm	●	●				
585 GG 1 cm	●	●		●		
585 GG 10 cm	●	●		●		
585 GG 100 cm	●	●				
585 WG 1 cm	●	●	●			
585 WG 10 cm	●	●	●			
585 WG 100 cm	●	●				
750 GG 1 cm	●	●		●		
750 GG 10 cm	●	●		●		
750 GG 100 cm	●	●				







<p>Venezianerkette, rund gezogen Meterware Venezia Chain, round, by meter</p> <p><i>Abgeschnittene Kettenstücke können weder umgetauscht noch zurückgenommen werden!!</i></p>							
	Ø in mm ca.	1,6	1,8	2,1	2,7		
	Artikel-Nr.	3116	3118	3121	3127		
	925 Silber 10 cm	•	•	•	•		
	925 Silber 100 cm	•	•	•	•		
925 Silber 500 cm	•	•	•	•			
925 Silber 1000 cm	•	•	•	•			







<p>Ovale Erbskette, Meterware Oval pea chain, by meter</p> <p><i>Abgeschnittene Kettenstücke können weder umgetauscht noch zurückgenommen werden!!</i></p>						
	Abmessung Öse Länge x Breite in mm ca.	3,9 x 2,8	5,9 x 3,5	5,9 x 3,2 diamantiert		
	Artikel-Nr.	1108	1109	1109D		
	925 Silber 10 cm	•	•	•		
	925 Silber 100 cm	•	•	•		
925 Silber 500 cm	•	•	•			
925 Silber 1000 cm	•	•	•			

SUMA FURNITUREN

Mulde 10 D-75239 Eisingen ● ☎ +49 (0) 7232 809 454 ● 📠 +49 (0) 7232 809 453 ● ✉ info@sumafurnituren.de ● www.sumafurnituren.de







Erbskette, Meterware Pea Chain, by meter <i>Abgeschnittene Kettenstücke können weder umgetauscht noch zurückgenommen werden!!</i>								
	Gesamtbreite in mm ca.	1,4	1,7	1,7	2,0	2,3	2,7	3,2
Form der Ausführung			diam.				schwer	
Artikel-Nr.	1614	1618	1618D	1620	1623	1627	1632	1635
925 Silber 10 cm	•	•	•	•	•	•	•	•
925 Silber 100 cm	•	•	•	•	•	•	•	•
925 Silber 500 cm	•	•	•	•	•	•	•	•
925 Silber 1000 cm	•	•	•	•	•	•	•	•





Erbskette, Meterware Pea Chain, by meter <i>Abgeschnittene Kettenstücke können weder umgetauscht noch zurückgenommen werden!!</i>							
	Gesamtbreite in mm ca.	4,0	4,1	4,6	5,0	6,1	6,5
Form der Ausführung		schwer	schwer		schwer	schwer	
Artikel-Nr.	1640	1641	1645	1650	1661	1665	1670
925 Silber 10 cm	•	•	•	•	•	•	•
925 Silber 100 cm	•	•	•	•	•	•	•
925 Silber 500 cm	•	•	•	•	•	•	•
925 Silber 1000 cm	•	•		•			

<p>Erbskette, Meterware dichtes Muster, schwere Ausführung Pea Chain, by meter heavy version</p> <p><i>Abgeschnittene Kettenstücke können weder umgetauscht noch zurückgenommen werden!!</i></p>							
	Gesamtbreite in mm ca.	1,5	2,0	2,5	3,0	3,5	4,0
Form der Ausführung	dichtes Muster, schwere Ausführung						
Artikel-Nr.	1615	1621	1625	1630	1636	1642	1651
925 Silber 10 cm	●	●	●	●	●	●	●
925 Silber 100 cm	●	●	●	●	●	●	●
925 Silber 500 cm	●	●	●	●	●		
925 Silber 1000 cm	●	●	●	●	●		
333 GG 1 cm	●	●	●				
333 GG 10 cm	●	●	●				
585 GG 1 cm	●	●	●	●	●		
585 GG 10 cm	●	●	●	●	●		
585 WG 1 cm	●	●					
585 WG 10 cm	●	●					
750 GG 1 cm	●	●	●	●			
750 GG 10 cm	●	●	●	●			

SUMA FURNITUREN









Mulde 10 D-75239 Eisingen ● ☎ +49 (0) 7232 809 454 ● 📠 +49 (0) 7232 809 453 ● ✉ info@sumafurnituren.de ● www.sumafurnituren.de





Ankerkette, rund Meterware Cable Chain, round by meter								
<i>Abgeschnittene Kettenstücke können weder umgetauscht noch zurückgenommen werden!!</i>								
Drahtstärke in mm ca.		0,25	0,30	0,35	0,40	0,45	0,50	0,60
Gesamtbreite in mm ca.		0,9	1,1	1,4	1,6	1,75	1,9	2,4
Artikel-Nr.		1725	1730	1735	1740	1745	1750	1760
925 Silber	10 cm	•	•	•	•	•	•	•
925 Silber	100 cm	•	•	•	•	•	•	•
925 Silber	500 cm	•	•	•	•	•	•	•
925 Silber	1000 cm	•	•	•	•	•	•	•
333 GG	1 cm			•	•		•	
333 GG	10 cm			•	•		•	
333 GG	100 cm			•	•		•	
585 GG	1 cm	•	•	•	•	•	•	•
585 GG	10 cm	•	•	•	•	•	•	•
585 GG	100 cm	•	•	•	•	•	•	•
585 RotG	1 cm	•	•	•	•	•	•	•
585 RotG	10 cm	•	•	•	•	•	•	•
585 RotG	100 cm	•	•	•	•	•	•	•
590 WG	1 cm	•	•	•	•	•	•	•
590 WG	10 cm	•	•	•	•	•	•	•
590 WG	100 cm	•	•	•	•	•	•	•
750 GG	1 cm	•	•	•	•	•	•	•
750 GG	10 cm	•	•	•	•	•	•	•
750 GG	100 cm	•	•	•	•	•		
750 RotG	1 cm	•	•	•	•	•	•	•
750 RotG	10 cm	•	•	•	•	•	•	•
750 RotG	100 cm	•	•	•	•	•		
750 WG	1 cm	•	•	•	•	•	•	•
750 WG	10 cm	•	•	•	•	•	•	•
750 WG	100 cm	•	•	•	•	•		
950 Platin	1 cm		•	•	•		•	
950 Platin	10 cm		•	•	•		•	
950 Platin	100 cm		•	•	•			





<p>Ankerkette, rund Meterware Cable Chain, round by meter</p> <p><i>Abgeschnittene Kettenstücke können weder umgetauscht noch zurückgenommen werden!!</i></p>						
	Drahtstärke in mm ca.	0,80	1,0	1,2	1,5	1,8
Gesamtbreite in mm ca.	3,0	3,9	4,4	5,2	7,2	
Artikel-Nr.	1780	17100	17120	17150	17180	
925 Silber 10 cm	•	•	•	•	•	
925 Silber 100 cm	•	•	•	•	•	
925 Silber 500 cm	•	•	•			
925 Silber 1000 cm	•	•				
585 GG 1 cm	•					
585 GG 10 cm	•					
585 RotG 1 cm	•					
585 RotG 10 cm	•					
585 WG 1 cm	•					
585 WG 10 cm	•					
750 GG 1 cm	•					
750 GG 10 cm	•					
750 RotG 1 cm	•					
750 RotG 10 cm	•					
750 WG 1 cm	•					
750 WG 10 cm	•					

SUMA FURNITUREN

Mulde 10 D-75239 Eisingen ● ☎ +49 (0) 7232 809 454 ● 📠 +49 (0) 7232 809 453 ● ✉ info@sumafurnituren.de ● www.sumafurnituren.de





<p>Weitankerkette, rund Meterware Wide Cable Chain, round by meter</p> <p><i>Abgeschnittene Kettenstücke können weder umgetauscht noch zurückgenommen werden!!</i></p>								
Drahtstärke in mm ca.	0,40	0,40	0,50	0,50	0,50	0,60	0,60	0,80
Gesamtbreite in mm ca.	1,6	2,0	2,0	2,5	2,5	2,4	3,0	3,0
Artikel-Nr.	1741	1741	1751	1751A	1751	1761	1761	1781
925 Silber 10 cm	•		•	•		•		•
925 Silber 100 cm	•		•	•		•		•
925 Silber 500 cm	•		•	•		•		•
925 Silber 1000 cm	•		•	•		•		•
333 GG 1 cm		•					•	
333 GG 10 cm		•					•	
333 GG 100 cm		•					•	
585 GG 1 cm		•			•		•	
585 GG 10 cm		•			•		•	
585 GG 100 cm		•			•		•	
585 RotG 1 cm		•			•			
585 RotG 10 cm		•			•			
585 RotG 100 cm		•			•			
590 WG 1 cm		•			•		•	
590 WG 10 cm		•			•		•	
590 WG 100 cm		•			•		•	
750 GG 1 cm		•			•		•	
750 GG 10 cm		•			•		•	
750 GG 100 cm		•			•		•	
750 RotG 1 cm		•			•			
750 RotG 10 cm		•			•			
750 RotG 100 cm		•			•			
750 WG 1 cm		•						
750 WG 10 cm		•						
750 WG 100 cm		•						

Weitankerkette, rund Meterware Wide Cable Chain, round by meter <i>Abgeschnittene Kettenstücke können weder umgetauscht noch zurückgenommen werden!!</i>						
	Drahtstärke in mm ca.	0,50	0,60	0,60 flach, glatt	0,65	
Gesamtbreite in mm ca.	2,7	3,4	3,5	3,5		
Artikel-Nr.	1752	1762	1763	1765		
925 Silber 10 cm	●	●	●	●		
925 Silber 100 cm	●	●	●	●		
925 Silber 500 cm	●	●	●	●		
925 Silber 1000 cm	●	●	●	●		
333 GG 1 cm				●		
333 GG 10 cm				●		
585 GG 1 cm				●		
585 GG 10 cm				●		
750 GG 1 cm				●		
750 GG 10 cm				●		
750 RotG 1 cm				●		
750 RotG 10 cm				●		

Weitankerkette Meterware Wide Cable Chain by meter <i>Abgeschnittene Kettenstücke können weder umgetauscht noch zurückgenommen werden!!</i>						
	Drahtstärke in mm ca.	0,70	0,70 flach, glatt	0,70 flach, eismatt	1,0	
Gesamtbreite in mm ca.	5,6	5,7	5,7	4,4		
Artikel-Nr.	1772	1773	1774	17102		
925 Silber 10 cm	●	●	●	●		
925 Silber 100 cm	●	●	●	●		
925 Silber 500 cm	●	●	●	●		
925 Silber 1000 cm	●	●	●	●		

SUMA FURNITUREN

Mulde 10 D-75239 Eisingen • ☎ +49 (0) 7232 809 454 • 📠 +49 (0) 7232 809 453 • ✉ info@sumafurnituren.de • www.sumafurnituren.de

<p>Weitankerkette, rund, längliche Form, Meterware Wide Cable Chain, round by meter</p> <p><i>Abgeschnittene Kettenstücke können weder umgetauscht noch zurückgenommen werden!!</i></p>	NEU	NEU	NEU	NEU			
							
	Drahtstärke in mm ca.	0,50	0,60	0,80	1,0		
	Gesamtbreite in mm ca.	1,9	2,3	3,5	4,2		
	Länge Öse in mm ca.	3,8	5,4	6,8	8,0		
Artikel-Nr.	52050	52060	52080	52100			
925 Silber 10 cm	•	•	•	•			
925 Silber 100 cm	•	•	•	•			
925 Silber 500 cm	•	•	•	•			
925 Silber 1000 cm	•	•	•	•			

Diamantierte Ankerketten, mit radialem Diamantschnitt Diamond-cutted cable chain, with radial diamond cutting

Flächiger, radialer Diamantschnitt auf jeder Öse. Dadurch erhält die Kette einen besonders starken Glanz.



Ankerkette, diamantiert, Meterware Cable Chain, with diamond-cut, by meter <i>Abgeschnittene Kettenstücke können weder umgetauscht noch zurückgenommen werden!!</i>						
	Drahtstärke in mm ca.	0,35	0,40	0,50	0,60	
Gesamtbreite in mm ca.	1,3	1,4	2,0	2,2		
Artikel-Nr.	1735MD	1740MD	1750MD	1760MD		
925 Silber 10 cm	•	•	•	•		
925 Silber 100 cm	•	•	•	•		
925 Silber 500 cm	•	•	•	•		
925 Silber 1000 cm	•	•	•	•		

Diamantierte Ankerketten / Diamond-cutted cable chain

in Silber:
Diamantschnitt als spitze Dachform



in Gold:
Diamantschnitt, flach, auf der Öse



Ankerkette, diamantiert Meterware Cable Chain, with diamond cut by meter <i>Abgeschnittene Kettenstücke können weder umgetauscht noch zurückgenommen werden!!</i>						
	0,30	0,35	0,40	0,50	0,60	0,80
Drahtstärke in mm ca.	0,30	0,35	0,40	0,50	0,60	0,80
Gesamtbreite in mm ca.	1,1	1,3	1,5	1,9	2,1	2,9
Artikel-Nr.	1730D	1735D	1740D	1750D	1760D	1780D
925 Silber 10 cm	•	•	•	•	•	•
925 Silber 100 cm	•	•	•	•	•	•
925 Silber 500 cm	•	•	•	•	•	•
925 Silber 1000 cm	•	•	•	•	•	•

Ankerkette, diamantiert Meterware Cable Chain, with diamond cut by meter <i>Abgeschnittene Kettenstücke können weder umgetauscht noch zurückgenommen werden!!</i>						
	1,0					
Drahtstärke in mm ca.	1,0					
Gesamtbreite in mm ca.	3,6					
Artikel-Nr.	17100D					
925 Silber 10 cm	•					
925 Silber 100 cm	•					
925 Silber 500 cm	•					

Diamantierte Ankerketten / Diamond-cutted cable chain

in Silber:
Diamantschnitt als spitze Dachform



in Gold:
Diamantschnitt, flach, auf der Öse









Ankerkette, flach diamantiert Meterware Cable Chain, flat, with diamond cut by meter <i>Abgeschnittene Kettenstücke können weder umgetauscht noch zurückgenommen werden!!</i>						
	Drahtstärke in mm ca.	0,30	0,35	0,40	0,45	0,50
Gesamtbreite in mm ca.	0,9	1,1	1,3	1,5	1,6	1,9
Artikel-Nr.	1730F	1735F	1740F	1745F	1750F	1760F
585 GG 1 cm	•	•	•	•	•	•
585 GG 10 cm	•	•	•	•	•	•
585 GG 100 cm	•	•	•	•	•	
585 RotG 1 cm	•	•	•	•	•	
585 RotG 10 cm	•	•	•	•	•	
585 RotG 100 cm	•	•	•	•	•	
590 WG 1 cm	•	•	•	•	•	•
590 WG 10 cm	•	•	•	•	•	•
590 WG 100 cm	•	•	•	•	•	
750 GG 1 cm	•	•	•	•	•	•
750 GG 10 cm	•	•	•	•	•	•
750 GG 100 cm	•	•	•	•	•	
750 RotG 1 cm	•	•	•	•	•	
750 RotG 10 cm	•	•	•	•	•	
750 RotG 100 cm	•	•	•	•	•	
750 WG 1 cm	•	•	•	•	•	
750 WG 10 cm	•	•	•	•	•	
750 WG 100 cm	•	•	•	•	•	





SUMA FURNITUREN

Mulde 10 D-75239 Eisingen ● ☎ +49 (0) 7232 809 454 ● 📠 +49 (0) 7232 809 453 ● ✉ info@sumafurnituren.de ● www.sumafurnituren.de

<p>Fuchsschwanzkette, vierkant, Meterware ■-Profil Foxtail Chain, quadrati- cal, by meter</p> <p><i>Abgeschnittene Kettenstücke können weder umgetauscht noch zurückgenommen werden!!</i></p>						
	Abmessung in mm ca.	1,2 x 1,2	1,3 x 1,3	1,4 x 1,4	1,6 x 1,6	1,7 x 1,7
Artikel-Nr.	2212	2213	2214	2216	2217	2219
925 Silber 10 cm	●	●	●	●	●	●
925 Silber 100 cm	●	●	●	●	●	●
925 Silber 500 cm	●	●	●	●	●	●
585 GG 1 cm	●	●	●	●		
585 GG 10 cm	●	●	●	●		
585 GG 100 cm	●	●	●	●		
585 WG 1 cm	●	●				
585 WG 10 cm	●	●				
585 WG 100 cm	●	●				
750 GG 1 cm	●	●	●	●		
750 GG 10 cm	●	●	●	●		
750 GG 100 cm	●	●				

<p>Fuchsschwanzkette, vierkant, Meterware ■-Profil Foxtail Chain, quadrati- cal, by meter</p> <p><i>Abgeschnittene Kettenstücke können weder umgetauscht noch zurückgenommen werden!!</i></p>						
	Abmessung in mm ca.	2,2 x 2,2	2,6 x 2,6	3,0 x 3,3	3,4 x 3,4	4,6 x 5,0
Artikel-Nr.	2222	2226	2230	2234	2246	
925 Silber 10 cm	●	●	●	●	●	
925 Silber 100 cm	●	●	●	●	●	
925 Silber 500 cm	●	●				

<p>Fuchsschwanzkette, rund gezogen, Meterware ●-Profil Foxtail Chain, drawn round, by meter</p> <p><i>Abgeschnittene Kettenstücke können weder umgetauscht noch zurückgenommen werden!!</i></p>							
	Ø Kette in mm ca.	1,0	1,3	1,5	1,7	1,9	2,5
Artikel-Nr.	2210R	2213R	2215R	2217R	2219R	2225R	2232R
925 Silber 10 cm	•	•	•	•	•	•	•
925 Silber 100 cm	•	•	•	•	•	•	•
925 Silber 500 cm	•	•	•	•	•	•	•
585 GG 1 cm	•	•	•	•			
585 GG 10 cm	•	•	•	•			
750 GG 1 cm	•	•	•	•			
750 GG 10 cm	•	•	•	•			

<p>Foxschlauchkette, rund, Meterware ○-Profil Foxtail chain, drawn round, by meter</p> <p><i>Abgeschnittene Kettenstücke können weder umgetauscht noch zurückgenommen werden!!</i></p>					
	Ø Kette in mm ca.	3,1	3,6	4,2	4,9
Artikel-Nr.	2931F	2936F	2942F	2956F	2956F
925 Silber 10 cm	•	•	•	•	•
925 Silber 100 cm	•	•	•	•	•









Kugelketten





Unsere Kugelketten (ab Ø 1,5 mm) in Silber werden aus starkem Rohrmaterial gefertigt und somit erhalten sie eine sehr hohe Zugfestigkeit. Die Kugeln sind rund, geschlossen und weisen keinerlei Fugen o.ä. auf, sodass problemlos an den Ketten gelötet werden kann.

Ball Chains

Our Ball chains (from Ø 1,5 mm) in silver are produced from strong tubes and so they reach a high tensile strength. The balls are round, closed and have no joint so that you can work and solder the chain without any difficulties.







Kugelkette, rund, Meterware Ball Chain, round, by meter <i>Abgeschnittene Kettenstücke können weder umgetauscht noch zurückgenommen werden!!</i>						
	Ø in mm ca.	1,0	1,2	1,5	1,8	2,0
Artikel-Nr.	1010	1012	1015	1018	1020	1022
925 Silber 10 cm	•	•	•	•	•	•
925 Silber 100 cm	•	•	•	•	•	•
925 Silber 500 cm	•	•	•	•	•	•
925 Silber 1000 cm	•	•	•	•	•	•
585 GG 1 cm	•	•	•		•	•
585 GG 10 cm	•	•	•		•	•
585 GG 100 cm	•	•	•		•	•
585 RotG 1 cm		•				
585 RotG 10 cm		•				
585 RotG 100 cm		•				
585 WG 1 cm		•			•	
585 WG 10 cm		•			•	
585 WG 100 cm		•			•	
750 GG 1 cm		•	•		•	
750 GG 10 cm		•	•		•	
750 GG 100 cm		•	•		•	
750 RotG 1 cm		•	•		•	
750 RotG 10 cm		•	•		•	
750 RotG 100 cm		•	•		•	
750 WG 1 cm		•	•		•	
750 WG 10 cm		•	•		•	
750 WG 100 cm		•	•		•	







<p>Kugelkette, rund, Meterware Ball Chain, round, by meter</p> <p><i>Abgeschnittene Kettenstücke können weder umgetauscht noch zurückgenommen werden!!</i></p>						
	Ø in mm ca.	2,5	3,0	4,0	4,5	5,0
Artikel-Nr.	1025	1030	1040	1045	1050	1060
925 Silber 10 cm	•	•	•	•	•	•
925 Silber 100 cm	•	•	•	•	•	•
925 Silber 500 cm	•	•	•	•	•	•
925 Silber 1000 cm	•	•	•			
585 GG 1 cm	•					
585 GG 10 cm	•					







<p>Kugelkette, rund, diamantiert-facettiert, Meterware Ball Chain, round with diamond cut, by meter</p> <p><i>Abgeschnittene Kettenstücke können weder umgetauscht noch zurückgenommen werden!!</i></p>						
	Ø in mm ca.	1,1	1,2	1,5	1,8	2,0
Artikel-Nr.	1011D	1012D	1015D	1018D	1020D	
925 Silber 10 cm		•	•	•	•	
925 Silber 100 cm		•	•	•	•	
925 Silber 500 cm		•	•	•	•	
925 Silber 1000 cm		•	•	•	•	
750 GG 1 cm	•					
750 GG 10 cm	•					
750 GG 100 cm	•					
750 RotG 1 cm	•					
750 RotG 10 cm	•					
750 RotG 100 cm	•					





SUMA FURNITUREN

Mulde 10 D-75239 Eisingen • ☎ +49 (0) 7232 809 454 • 📠 +49 (0) 7232 809 453 • ✉ info@sumafurnituren.de • www.sumafurnituren.de

Kombikugelkette, Olivkette, Meterware Ball Chain, Oval ball chain, by meter <i>Abgeschnittene Kettenstücke können weder umgetauscht noch zurückgenommen werden!!</i>						
	Abmessungen in mm ca.	1,5	1,5	1,8	1,8	3,0
Artikel-Nr.	1112	1114	1116	1118	1130	1140
925 Silber 10 cm	•	•	•	•	•	•
925 Silber 100 cm	•	•	•	•	•	•
925 Silber 500 cm	•	•	•	•	•	•
925 Silber 1000 cm	•	•	•	•	•	

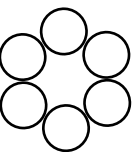
Mehrreihige Kugelkette, rund, Meterware Multiple-row ball Chain, round, by meter <i>Abgeschnittene Kettenstücke können weder umgetauscht noch zurückgenommen werden!!</i>  Zweireihig  Dreireihig						
	Ø der Kugeln ca.	1,5	2,0		1,5	2,0
Gesamtbreite in mm ca.	3,0	4,0		4,5	6,0	
Artikel-Nr.	2415	2420		2515	2520	
925 Silber 10 cm	•	•		•	•	
925 Silber 100 cm	•	•		•	•	

<p>Vierreihige Kugelkette, rund, Meterware Four-row ball Chain, round, by meter</p> <p><i>Abgeschnittene Kettenstücke können weder umgetauscht noch zurückgenommen werden!!</i></p> 							
	Ø der Kugeln ca.	1,0	1,2	1,5	1,0	1,2	1,5
	Gesamtbreite in mm ca.	2,0	2,4	3,0	2,0	2,4	3,0
	Kugeln	rund, glatt / round, smooth			diamantiert / with diamond-cut		
Artikel-Nr.	4710	4712	4715	4710D	4712D	4715D	
925 Silber 10 cm	●	●	●	●	●	●	
925 Silber 100 cm	●	●	●	●	●	●	
925 Silber 500 cm	●	●	●	●	●	●	

<p>Sechsstufige Kugelkette, rund, Meterware Six-row ball Chain, round, by meter</p> <p><i>Abgeschnittene Kettenstücke können weder umgetauscht noch zurückgenommen werden!!</i></p> 							
	Ø der Kugeln ca.	1,0	1,2	1,5			
	Gesamtbreite in mm ca.	3,0	3,6	4,5			
	Kugeln	rund, glatt / round, smooth					
Artikel-Nr.	4810	4812	4815				
925 Silber 10 cm	●	●	●				
925 Silber 100 cm	●	●	●				
925 Silber 500 cm	●	●	●				

SUMA FURNITUREN

Mulde 10 D-75239 Eisingen • ☎ +49 (0) 7232 809 454 • 📠 +49 (0) 7232 809 453 • ✉ info@sumafurnituren.de • www.sumafurnituren.de



4140



4240

Venezianer-Schlauch-Kette, rechteckige, flache Kettenglieder <i>Abgeschnittene Kettenstücke können weder umgetauscht noch zurückgenommen werden!!</i>					
	Ketten-Ø in mm ca.	2,8	4,0	6,0	7,0
Artikel-Nr.	4128	4140	4160	4170	
925 Silber 10 cm	•	•	•	•	
925 Silber 100 cm	•	•	•	•	
925 Silber 500 cm	•	•	•	•	

Venezianer-Schlauch-Kette, rechteckige Kettenglieder, nach außen bombiert <i>Abgeschnittene Kettenstücke können weder umgetauscht noch zurückgenommen werden!!</i>					
	Ketten-Ø in mm ca.	3,0	4,0	4,5	6,0
Artikel-Nr.	4230	4240	4245	4260	4270
925 Silber 10 cm	•	•	•	•	•
925 Silber 100 cm	•	•	•	•	•
925 Silber 500 cm	•	•	•	•	•



4230D



4330





4420



Venezianer-Schlauch-Kette, diamantiert <i>Abgeschnittene Kettenstücke können weder umgetauscht noch zurückgenommen werden!!</i>					
	rechteckige Kettenglieder, nach außen bombiert, diamantiert			runde Kettenglieder, flach	
Ketten-Ø in mm ca.	3,0			3,0	4,0
Artikel-Nr.	4230D			4330	4340
925 Silber 10 cm	•			•	•
925 Silber 100 cm	•			•	•
925 Silber 500 cm	•			•	•



Venezianer-Schlauch-Kette, runde Kettenglieder, nach außen bombiert, diamantiert <i>Abgeschnittene Kettenstücke können weder umgetauscht noch zurückgenommen werden!!</i>					
	Ketten-Ø in mm ca.	1,6	1,8	2,0	2,5
Artikel-Nr.	4416	4418	4420	4425	4430
925 Silber 10 cm	•	•	•	•	•
925 Silber 100 cm	•	•	•	•	•
925 Silber 500 cm	•	•	•	•	•



SUMA FURNITUREN



Mulde 10 D-75239 Eisingen • ☎ +49 (0) 7232 809 454 • 📠 +49 (0) 7232 809 453 • ✉ info@sumafurnituren.de • www.sumafurnituren.de

Große Erbskette lang-oval / oval Large, drawn / oval pea chain						
Abmessungen in mm ca.	8,0 x 3,7 / 0,6 x 1,4			7,1 x 5,0 / 0,65 x 1,4		
Artikel-Nr.	2000			2002		
	10 cm	100 cm	500 cm	10 cm	100 cm	500 cm
925 Silber	•	•	•	•	•	•



Große Erbskette oval Large, drawn pea chain						
Abmessungen in mm ca.	9,4 x 6,4 / 1,9			7,0 x 5,0 / 1,6 (diamantiert, Messerdrahtform)		
Artikel-Nr.	2006			2007		
	10 cm	100 cm	500 cm	10 cm	100 cm	500 cm
925 Silber	•	•	•	•	•	•



Große Erbskette oval / Große Flachankerkette rund Large, drawn pea chain / Large, flat cable chain, round						
Abmessungen in mm ca.	8,7 x 5,4 / 1,7			7,0 / 1,6		
Artikel-Nr.	2008			2010		
	10 cm	100 cm	500 cm	10 cm	100 cm	500 cm
925 Silber	•	•	•	•	•	•



Große Flachankerkette rund Large, flat cable chain, round						
Abmessungen in mm ca.	10,0 / 0,5 x 1,0			13,0 / 0,6 x 1,3		
Artikel-Nr.	2011			2012		
	10 cm	100 cm	500 cm	10 cm	100 cm	500 cm
925 Silber	•	•	•	•	•	•



Große Ankerkette rund Large cable chain, round						
Abmessungen in mm ca.	10,0 / 0,9			12,5 / 0,9		
Artikel-Nr.	2013			2014		
	10 cm	100 cm	500 cm	10 cm	100 cm	500 cm
925 Silber	•	•	•	•	•	•

Abgeschnittene Kettenstücke können weder umgetauscht noch zurückgenommen werden!!

Große Ankerkette rund / Große Flachankerkette rund Large cable chain, round / Large, flat cable chain, round						
Abmessungen in mm ca.	Ø 10,0 / 0,7			Ø 22,0 / 1,3 x 0,6		
Artikel-Nr.	2015			2017		
	10 cm	100 cm	500 cm	10 cm	100 cm	500 cm
925 Silber	•	•	•	•	•	•

Große Flachankerkette rund, eismatt / gehämmert Large, flat cable chain, round, patterned / hammered						
Abmessungen in mm ca.	Ø 10,0 / 1,3 x 0,6 eismatt			Ø 10,0 / 2,0 x 0,5 gehämmert		
Artikel-Nr.	2018			2019		
	10 cm	100 cm	500 cm	10 cm	100 cm	500 cm
925 Silber	•	•	•	•	•	•

Große Flachankerkette rund, gehämmert / Große Ankerkette, rund, gekordelt Large, flat cable chain, round, hammered / Large cable chain, round, twisted						
Abmessungen in mm ca.	Ø 13,0 / 1,3 x 0,6 gehämmert			Ø 12,8 / 0,9 gekordelt		
Artikel-Nr.	2020			2023		
	10 cm	100 cm	500 cm	10 cm	100 cm	500 cm
925 Silber	•	•	•	•	•	•



Große Ankerkette, rund, gekordelt / Große Flachankerkette, Navette, eismatt Large cable chain, round, twisted / Large, flat cable chain, navette, patterned						
Abmessungen in mm ca.	Ø 10,0 / 0,5 gekordelt			15,5 x 7,4 / 1,3 x 0,5 eismatt		
Artikel-Nr.	2024			2025		
	10 cm	100 cm	500 cm	10 cm	100 cm	500 cm
925 Silber	•	•	•	•	•	•

Abgeschnittene Kettenstücke können weder umgetauscht noch zurückgenommen werden!!

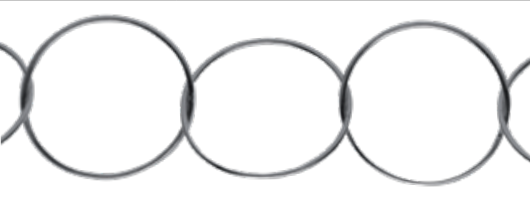

SUMA FURNITUREN



Mulde 10 D-75239 Eisingen • ☎ +49 (0) 7232 809 454 • 📠 +49 (0) 7232 809 453 • ✉ info@sumafurnituren.de • www.sumafurnituren.de



Große Flachanker- kette oval, gehämmert / Große Ankerkette rund Large, flat cable chain, oval, hammered / Large cable chain, round						
Abmessungen in mm ca.	15,0 x 8,0 / 1,4 x 0,5 gehämmert			Ø 22,0 / 0,9		
Artikel-Nr.	2026			2033		
	10 cm	100 cm	500 cm	10 cm	100 cm	500 cm
925 Silber	•	•	•	•	•	•

Große Ankerkette rund / Große Erbskette oval Large cable chain, round / Large, drawn pea chain						
Abmessungen in mm ca.	Ø 27,0 / 0,9			7,1 x 5,0 / 0,8		
Artikel-Nr.	2034			2038		
	10 cm	100 cm	500 cm	10 cm	100 cm	500 cm
925 Silber	•	•	•	•	•	•

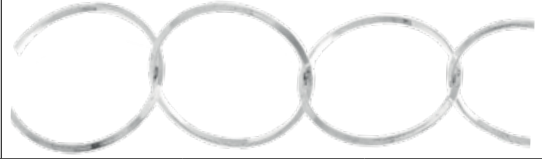
Abgeschnittene Kettenstücke können weder umgetauscht noch zurückgenommen werden!!

Große Erbskette, „Messerdrahtform“, rund Large pea chain, triangular wire, rund						
Abmessungen in mm ca.	Ø 10 / Drahthöhe: 1,0 / Drahtbreite: 1,3			Ø 13 / Drahthöhe: 1,0 / Drahtbreite: 1,3		
Artikel-Nr.	2600			2601		
	10 cm	100 cm	500 cm	10 cm	100 cm	500 cm
925 Silber	•	•	•	•	•	•

Große Erbskette, „Messerdrahtform“, rund / oval Large pea chain, triangular wire, rund / oval						
Abmessungen in mm ca.	Ø 21,5 / Drahthöhe: 1,0 / Drahtbreite: 1,3			12,0 x 6,0 / Drahthöhe: 1,0 / Drahtbreite: 1,3		
Artikel-Nr.	2602			2603		
	10 cm	100 cm	500 cm	10 cm	100 cm	500 cm
925 Silber	•	•	•	•	•	•



Große Erbskette, oval „Messerdrahtform“ Large pea chain, oval, triangular wire						
Abmessungen in mm ca.	14,5 x 7,5 / Drahthöhe: 1,0 / Drahtbreite: 1,3			26,5 x 17,1 / Drahthöhe: 1,0 / Drahtbreite: 1,3		
Artikel-Nr.	2604			2605		
	10 cm	100 cm	500 cm	10 cm	100 cm	500 cm
925 Silber	•	•	•	•	•	•



Große Erbskette, lang-oval „Messerdrahtform“ Large, drawn pea chain, triangular wire						
Abmessungen in mm ca.	26,5 x 8,6 / Drahthöhe: 1,0 / Drahtbreite: 1,3					
Artikel-Nr.	2606					
	10 cm	100 cm	500 cm			
925 Silber	•	•	•			



Abgeschnittene Kettenstücke können weder umgetauscht noch zurückgenommen werden!!

SUMA FURNITUREN



Mulde 10 D-75239 Eisingen • ☎ +49 (0) 7232 809 454 • 📠 +49 (0) 7232 809 453 • ✉ info@sumafurnituren.de • www.sumafurnituren.de

Gliederkette rund, längliche Form Link chain, round wire, long form	(NEU)			(NEU)		
						
Drahtstärke in mm ca.	0,60			0,70		
Gesamtbreite in mm ca.	3,9			3,4		
Länge Öse in mm ca.	15,2			10,6		
Artikel-Nr.	40065			40070		
	10 cm	100 cm	500 cm	10 cm	100 cm	500 cm
925 Silber	•	•	•	•	•	•

Gliederkette rund, längliche Form Link chain, round wire, long form	(NEU)			(NEU)		
						
Drahtstärke in mm ca.	0,90			0,90		
Gesamtbreite in mm ca.	3,7			4,4		
Länge Öse in mm ca.	8,8			15,7		
Artikel-Nr.	40090			40091		
	10 cm	100 cm	500 cm	10 cm	100 cm	500 cm
925 Silber	•	•	•	•	•	•

Gliederkette rund, längliche Form Link chain, round wire, long form	(NEU)			(NEU)		
						
Drahtstärke in mm ca.	0,90 / diamantiert			0,90 / Flachdraht		
Gesamtbreite in mm ca.	3,7			4,0		
Länge Öse in mm ca.	8,7			9,0		
Artikel-Nr.	40090D			40090F		
	10 cm	100 cm	500 cm	10 cm	100 cm	500 cm
925 Silber	•	•	•	•	•	•

Abgeschnittene Kettenstücke können weder umgetauscht noch zurückgenommen werden!!

Gliederkette rund, längliche Form Link chain, round wire, long form	NEU			NEU		
						
Drahtstärke in mm ca.	1,10			1,10 / diamantiert		
Gesamtbreite in mm ca.	4,8			4,8		
Länge Öse in mm ca.	13,4			13,4		
Artikel-Nr.	40110			40110D		
	10 cm	100 cm	500 cm	10 cm	100 cm	500 cm
925 Silber	•	•	•	•	•	•

Abgeschnittene Kettenstücke können weder umgetauscht noch zurückgenommen werden!!



Stahlseile

*aus rostfreiem Edelstahl
hergestellt in Deutschland
erstklassige Qualität
bestehend aus 49 Strängen
höchst flexibel*

Steel ropes

*stainless steel
made in Germany
First class quality
consisting of 49 strands
high-flexible*

*bestehend aus 49 Strängen
hoch flexibel, nicht ummantelt*

*consisting of 49 strands
high-flexible, uncoated*

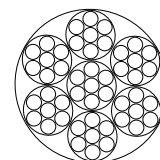

Edelstahlseile

Steel ropes

Ø in mm ca.		0,27	0,32	0,36	0,45
Artikel-Nr.		8427/ST	8432/ST	8436/ST	8445/ST
	1 m	•	•	•	•
1 Spule	10 m	•	•	•	•
1 Spule	30 m	•	•	•	•
1 Spule	100 m	•	•	•	•

Ø in mm ca.		0,63	0,72	0,90	
Artikel-Nr.		8463/ST	8472/ST	8491/ST	
	1 m	•	•	•	
1 Spule	10 m	•	•	•	
1 Spule	30 m	•	•	•	
1 Spule	100 m	•	•	•	

*bestehend aus 49 Strängen
hoch flexibel, transparent ummantelt*

*consisting of 49 strands
high-flexible, transparent coated*

Edelstahlseile

Steel ropes

Ø in mm ca.		0,60	0,90		
Artikel-Nr.		8460/ST	8490/ST		
	1 m	•	•		
1 Spule	10 m	•	•		
1 Spule	30 m	•	•		
1 Spule	100 m	•	•		



Stahlseile

*aus Edelstahl rostfreiem Material
hergestellt in Deutschland
erstklassige Qualität*

Steel ropes

*stainless steel
made in Germany
First class quality*

*bestehend aus 19 Strängen
sehr flexibel, nicht ummantelt*

*consisting of 19 strands
very flexible, uncoated*

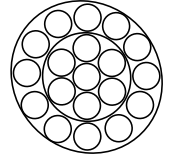

Edelstahlseile

Steel ropes

Ø in mm ca.	0,20	0,25	0,30	0,50	
Artikel-Nr.	9420/ST	9425/ST	9430/ST	9450/ST	
1 m	•	•	•	•	
1 Spule 10 m	•	•	•	•	
1 Spule 30 m	•	•	•	•	
1 Spule 100 m	•	•	•	•	



Stahlseile

aus rostfreiem Edelstahl
hergestellt in Deutschland
erstklassige Qualität
bestehend aus 49 Strängen
höchst flexibel

Steel ropes

stainless steel
made in Germany
First class quality
consisting of 49 strands
high-flexible

Edelstahlseile, goldplattiert
mit 20 Milliem Plattierauflage

Steel ropes, gold colour plated
20 Milliem gold-plated

Ø in mm ca.	0,45	0,54	0,63	0,72	0,90
Artikel-Nr. Feingold-Farbe	8445/STGP20	8454/STGP20	8463/STGP20	8472/STGP20	8491/STGP20
1 m	•	•	•	•	•
3 m	•	•	•	•	•
5 m	•	•	•	•	•
Artikel-Nr. Rotgold-Farbe	8445/STRGP20	8454/STRGP20	8463/STRGP20	8472/STRGP20	8491/STRGP20
1 m	•	•	•	•	•
3 m	•	•	•	•	•
5 m	•	•	•	•	•

Aus produktionstechnischen Gründen sind die 20 Milliem plattierten Edelstahlseile nur in 1 m-, 3 m- und 5 m-Stücken erhältlich. Preise für größere Abnahmemengen erhalten Sie auf Anfrage.

Edelstahlseile, goldplattiert
mit 5 Milliem Plattierauflage

Steel ropes, gold colour plated
5 Milliem gold-plated

Ø in mm ca.	0,45	0,54	0,63	0,72	0,90
Artikel-Nr. Feingold-Farbe	8445/STGP05	8454/STGP05	8463/STGP05	8472/STGP05	8491/STGP05
1 m	•	•	•	•	•
5 m	•	•	•	•	•
10 m	•	•	•	•	•
Artikel-Nr. Rotgold-Farbe	8445/STRGP05	8454/STRGP05	8463/STRGP05	8472/STRGP05	8491/STRGP05
1 m	•	•	•	•	•
5 m	•	•	•	•	•
10 m	•	•	•	•	•



Stahlseile

*aus rostfreiem Edelstahl
hergestellt in Deutschland
erstklassige Qualität
bestehend aus 49 Strängen
höchst flexibel*

Steel ropes

*stainless steel
made in Germany
First class quality
consisting of 49 strands
high-flexible*

Edelstahlseile, versilbert

Steel ropes, versilbert

Ø in mm ca.	0,45	0,54	0,63	0,72	0,90
Artikel-Nr. versilbert	8445/STVS	8454/STVS	8463/STVS	8472/STVS	8491/STVS
1 m	•	•	•	•	•
5 m	•	•	•	•	•
10 m	•	•	•	•	•

SUMA FURNITUREN

Mulde 10 D-75239 Eisingen • ☎ +49 (0) 7232 809 454 • 📠 +49 (0) 7232 809 453 • ✉ info@sumafurnituren.de • www.sumafurnituren.de



Quetschhülsen 8314 - 8325

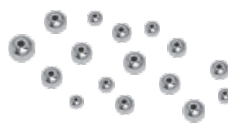

Quetschperlen 30018 - 30030/1,5

Quetschhülsen Crimps, tubes					
Außen-Ø in mm ca.	1,5	1,5	2,0	2,0	2,5
Innen-Ø in mm ca.	0,9	0,9	1,4	1,4	1,9
Länge in mm ca.	2,0	2,5	2,0	3,0	2,5
Artikel-Nr.	8314	8315	8319	8320	8325
Silber 10 St.	•	•	•	•	•
Silber 100 St.	•	•	•	•	•
Silber 1000 St.	•	•	•	•	•
Silber VG 10 St.	•	•	•	•	•
Silber VG 100 St.	•	•	•	•	•
Silber VG 1000 St.	•	•	•	•	•







Quetschperlen Crimps, beads					
Außen-Ø in mm ca.	1,8	2,0	2,5	3,0	3,0
Bohrungs-Ø in mm ca.	0,8	0,9	1,2	1,2	1,5
Artikel-Nr.	83018	83021	83026	83030	83031
Silber 10 St.	•	•	•	•	•
Silber 100 St.	•	•	•	•	•
Silber 1000 St.	•	•	•	•	•
Silber VG 10 St.	•	•	•	•	•
Silber VG 100 St.	•	•	•	•	•
Silber VG 1000 St.	•	•	•	•	•



Quetschzange zum Finieren von Stahl- seilen Plier for crimping		
	Anm.: Abbildungen verkleinert	
Länge der Zange ca.	13,5 cm	13,5 cm
für Ø in mm ca.	> 2,0	< 2,0
geeignet für	Art.-Nr. 8319 - 8325 und 30020 - 30030/1,5	Art.-Nr. 8314, 8315 und 30018
Artikel-Nr.	83100	83101
1 St.	•	•

Rundes, schwarzes Kautschukband in verbesserter Ausführung:

- tiefschwarze Farbe
- mit modernster Lasertechnik bearbeitete Oberfläche
- passgenau zu unseren runden, zylindrischen Kapseln auf den Seiten 89 - 90
- hoher Qualitätsstandard



Kautschukband, rund schwarz Rubber, round, black 						
	Ø in mm ca.	2,0	3,0	4,0	7,0	8,0
Artikel-Nr.	8120	8130	8140	8170	8180	81000
1 m	•	•	•	•	•	•
5 m				•	•	•
10 m	•	•	•	•	•	•
100 m	•	•	•			

Kautschukband, quadratisch, schwarz Rubber, quadratical, black 				
	Abmessungen in mm ca.	4 x 4		
Artikel-Nr.	8141			
1 m	•			
10 m	•			











Auflöt-Ornamente...







...beinhalten viele Motive sowie Ornamente und Seitenteile für schöne Schmuckstücke. Die Abbildungen sind meist vergrößert abgebildet für eine detaillierte Darstellung. Bitte beachten Sie die Maßangaben!
Auf Wunsch sind alle Modelle auch in anderen Legierungen (z.B. 18kt GG oder Weißgold) erhältlich. Weitere Modelle der Auflötornamente sind ebenso verfügbar. Bitte fragen Sie uns danach.







Ornaments for soldering...







...contain many motifs as well as ornaments and side parts for beautiful jewellery. Most of the times the pictures are enlarged for a detailed presentation. All models can also be produced in other alloys (e.g. 18kt YG or WG). Other motifs are also available. Please enquire!





Auflöt-Ornamente <i>Blätter, paarweise</i> Ornaments for soldering <i>leaves, pairs</i>						
Länge x Breite in mm ca.	25 x 11,5	25 x 11,5	10,8 x 8,5	10,8 x 8,5	17,1 x 5,6	17,1 x 5,6
Artikel-Nr.	109/957L	109/957R	109/1037L	109/1037R	109/1038L	109/1038R
935 Silber 1 St.	•	•	•	•	•	•
935 Silber 10 St.	•	•	•	•	•	•

Auflöt-Ornamente <i>Blätter, extra groß</i> Ornaments for soldering <i>leaves, extra large</i>			
Länge x Breite in mm ca.	66,3 x 30	47 x 17	
Artikel-Nr.	109/737	109/742	
935 Silber 1 St.	•	•	
935 Silber 10 St.	•	•	

Auflöt-Ornamente <i>Eichenlaub, einzel</i> Ornaments for soldering <i>oak leaves, single</i>							
Länge x Breite in mm ca.	9,8 x 3,4	13,8 x 4,4	17,7 x 5,9	21,5 x 7,5	10,0 x 4,9 gewölbt	13,7 x 6,0 gewölbt	20,7 x 7,0
Artikel-Nr.	109/509	109/336	109/337	109/338	109/555	109/424	109/866
935 Silber 1 St.	●	●	●	●	●	●	●
935 Silber 10 St.	●	●	●	●	●	●	●
585 GG 1 St.	●	●	●	●		●	





Auflöt-Ornamente <i>Eichenlaub, paarweise</i> Ornaments for soldering <i>oak leaves, pairs</i>						
Länge x Breite in mm ca.	12,7 x 4,7	12,7 x 4,7	13,0 x 4,7	13,0 x 4,7	18 x 6	18 x 6
Artikel-Nr.	109/891	109/892	109/841	109/842	109/635	109/636
935 Silber 1 St.	●	●	●	●	●	●
935 Silber 10 St.	●	●	●	●	●	●
585 GG 1 St.	●	●	●	●	●	●



Auflöt-Ornamente <i>Eichenlaub, Eicheln</i> Ornaments for soldering <i>oak leaves, acorns</i>							
Länge x Breite in mm ca.	15,0 x 16,5	11,0 x 15,5	16,0 x 11,7	6 x 2	10,8 x 2,4	13,0 x 3,25	7,2 x 4,8
Artikel-Nr.	109/698	109/890	109/1041	109/514K	109/940	109/514	109/722
935 Silber 1 St.	●	●	●	●	●	●	●
935 Silber 10 St.	●	●	●	●	●	●	●
585 GG 1 St.				●	●	●	●







Auflöt-Ornamente <i>Weinblätter, Weinrebe</i> Ornaments for soldering <i>vine leaves, grape-vine</i>					
Länge x Breite in mm ca.	9,4 x 8,4	12 x 14	12,0 x 20,5	10,0 x 9,0	12,7 x 15,5
Artikel-Nr.	109/693	109/692	109/894	109/681	109/717
935 Silber 1 St.	●	●	●	●	●
935 Silber 10 St.	●	●	●	●	●





SUMA FURNITUREN









Mulde 10 D-75239 Eisingen • ☎ +49 (0) 7232 809 454 • 📠 +49 (0) 7232 809 453 • ✉ info@sumafurnituren.de • www.sumafurnituren.de







Auflöt-Ornamente <i>Blätter, Pilz</i> Ornaments for soldering <i>leaves, mushroom</i>					
Länge x Breite in mm ca.	4,1 x 3,3	10,3 x 10,5	21,5 x 14,2	7,5 x 11,5	6,6 x 6,8
Artikel-Nr.	109/682	109/1036	109/1500	109/838	109/1023
935 Silber 1 St.	•	•	•	•	•
935 Silber 10 St.	•	•	•	•	•
585 GG 1 St.		•	•		•







Auflöt-Ornamente <i>Ornament mit Blumen und Blätter</i> Ornaments for soldering <i>ornaments with flowers and leaves</i>			
Länge x Breite in mm ca.	29 x 13,5	27 x 7	26,2 x 14
Artikel-Nr.	109/723	109/728	109/546
935 Silber 1 St.	•	•	•
935 Silber 10 St.	•	•	•







Auflöt-Ornamente <i>Blumen</i> Ornaments for soldering <i>flowers</i>						
Ø in mm ca.	5,8	5,7	4,4	3,8	6,0	6,1
Artikel-Nr.	109/21	109/0	109/753	109/690	109/1024	109/1025
935 Silber 1 St.	•	•	•	•	•	•
935 Silber 10 St.	•	•	•	•	•	•
585 GG 1 St.	•	•	•	•	•	•

Auflöt-Ornamente <i>Blumen</i> Ornaments for soldering <i>flowers</i>				
Ø in mm ca.	8,6	8,6	21,3	19,5
Artikel-Nr.	109/671	109/672	109/771	109/989
935 Silber 1 St.	•	•	•	•
935 Silber 10 St.	•	•	•	•
585 GG 1 St.	•	•		

Auflöt-Ornamente <i>Tiere</i> Ornaments for soldering <i>animals</i>								
Länge x Breite x Höhe in mm ca.	6,8 x 6,4 x 1,3	5,8 x 7,8 x 1,2	5,8 x 8,0 x 1,1	4,6 x 8,2 x 1,1	7,7 x 5,6 x 1,2	5,8 x 6,8 x 1,0	7,3 x 4,9 x 1,0	6,2 x 7,0 x 1,1
Artikel-Nr.	109/1026	109/1027	109/1028	109/1029	109/1032	109/1033	109/1034	109/1035
935 Silber 1 St.	•	•	•	•	•	•	•	•
935 Silber 10 St.	•	•	•	•	•	•	•	•
585 GG 1 St.	•	•		•	•			





Auflöt-Ornamente <i>div. Motive</i> Ornaments for soldering <i>motifs</i>						
Länge x Breite x Höhe in mm ca.	6,2 x 7,5 x 1,3	7,7 x 7,5 x 1,3	13,0 (mit Öse) x 10,5 x 3,2 massiv	5,2 x 1,0	4,7 x 0,6 massiv, flach	6,0 x 9,5
Artikel-Nr.	109/1018	109/1019	109/1017	109/1039	109/1042	109/1040
935 Silber 1 St.	•	•	•	•	•	•
935 Silber 10 St.	•	•	•	•	•	•
585 GG 1 St.	•			•	•	•





Auflöt-Ornamente <i>div. Motive</i> Ornaments for soldering <i>motifs</i>						
Länge x Breite x Höhe in mm ca.	14,0 x 18,0	2,8 x 6 (Inri) 13,0 x 10,1 massiv	6,8 x 13,3	13,8 x 12,2 x 1,3 massiv	7,8 x 10,1 x 1,3 massiv	15,2 x 10,0 x 1,5 massiv
Artikel-Nr.	109/718	109/861	109/719	109/694	109/786	109/781
935 Silber 1 St.	•	•	•	•	•	•
935 Silber 10 St.	•	•	•	•	•	•



Auflöt-Ornamente <i>div. Motive</i> Ornaments for soldering <i>motifs</i>						
Länge x Breite in mm ca.	6,4 x 7,3 massiv	10,7 x 10	16 x 11,5 massiv	12,7 x 10,8 massive	24 x 18,3 massiv	14,4 x 16
Artikel-Nr.	109/858	109/844	109/909	109/769	109/922	109/852
935 Silber 1 St.	•	•	•	•	•	•
935 Silber 10 St.	•	•	•	•	•	•
585 GG 1 St.	•	•				

SUMA FURNITUREN

Mulde 10 D-75239 Eisingen • ☎ +49 (0) 7232 809 454 • 📠 +49 (0) 7232 809 453 • ✉ info@sumafurnituren.de • www.sumafurnituren.de



Auflöt-Ornamente <i>Wappen, einzeln</i> Ornaments for soldering <i>coat of arms, single</i>					
Länge x Breite x Höhe in mm ca.	14,0 x 13,2	14,0 x 13,0 massiv	13,0 x 12,0 hohl	16,0 x 13,5 hohl	16,0 x 13,5 massiv
Artikel-Nr.	109/863	109/935	109/936	109/937	109/937M
935 Silber 1 St.	•	•	•	•	•
935 Silber 10 St.	•	•	•	•	•









Auflöt-Ornamente <i>div. Motive, Kränze</i> Ornaments for soldering <i>motifs, wreaths</i>				
Länge x Breite x Höhe in mm ca.	9,5 x 13,0 x 5,5	11,3 x 15,0 x 5,8	19,5 massive Ausführung	27,0 massive Ausführung
Artikel-Nr.	109/696	109/1211	109/676	109/752
935 Silber 1 St.	•	•	•	•
935 Silber 10 St.	•	•	•	•









Auflöt-Ornamente <i>Dekor, einzeln,</i> <i>extra groß</i> Ornaments for soldering <i>decoration, single,</i> <i>extra large</i>			
Länge x Breite in mm ca.	23,0 x 34,7 x 1,0	15,5 x 38,8 x 1,1	
Artikel-Nr.	109/724	109/729	
935 Silber 1 St.	•	•	
935 Silber 10 St.	•	•	









SUMA FURNITUREN

Mulde 10 D-75239 Eisingen ● ☎ +49 (0) 7232 809 454 ● 📠 +49 (0) 7232 809 453 ● ✉ info@sumafurnituren.de ● www.sumafurnituren.de

Auflöt-Ornamente <i>Dekor, einzeln, extra groß</i> Ornaments for soldering <i>decoration, single, extra large</i>			
Länge x Breite in mm ca.	49,0 x 24,4 x 1,2	27,7 x 25,5 x 4,0	42 x 21
Artikel-Nr.	109/713	109/720	109/956
935 Silber 1 St.	•	•	•
935 Silber 10 St.	•	•	•





Auflöt-Ornamente <i>Ornamente, paarweise</i> Ornaments for soldering <i>ornaments, pairs</i>								
Länge x Breite x Höhe in mm ca.	8,5 x 6,5 x 1,8	8,5 x 6,5 x 1,8	5,0 x 4,2 x 1,2	5,0 x 4,2 x 1,2	7,8 x 3,7 x 1,3	7,8 x 3,7 x 1,3	7,7 x 4,7 x 1,8	7,7 x 4,7 x 1,8
Artikel-Nr.	109/530L	109/530R	109/596L	109/596R	109/663L	109/663R	109/664L	109/664R
935 Silber 1 St.	•	•	•	•	•	•	•	•
935 Silber 10 St.	•	•	•	•	•	•	•	•
585 GG 1 St.	•	•						







Auflöt-Ornamente <i>Ornamente, paarweise</i> Ornaments for soldering <i>ornaments, pairs</i>								
Länge x Breite x Höhe in mm ca.	7,5 x 4,0 x 1,6	7,5 x 4,0 x 1,6	8,0 x 4,6 x 1,7	8,0 x 4,6 x 1,7	5,5 x 3,5 x 1,5	5,5 x 3,5 x 1,5	6,0 x 3,5 x 1,7	6,0 x 3,5 x 1,7
Artikel-Nr.	109/665L	109/665R	109/666L	109/666R	109/667L	109/667R	109/668L	109/668R
935 Silber 1 St.	•	•	•	•	•	•	•	•
935 Silber 10 St.	•	•	•	•	•	•	•	•







Auflöt-Ornamente <i>Ornamente, paarweise</i> Ornaments for soldering <i>ornaments, pairs</i>								
Länge x Breite x Höhe in mm ca.	5,0 x 3,4 x 1,2	5,0 x 3,4 x 1,2	9,8 x 7,0 x 2,4 gewölbt	9,8 x 7,0 x 2,4 gewölbt	8,2 x 5,2 x 1,8	8,2 x 5,2 x 1,8	7,5 x 4,6 x 1,5	7,5 x 4,6 x 1,5
Artikel-Nr.	109/669L	109/669R	109/735	109/736	109/764L	109/764R	109/845L	109/845R
935 Silber 1 St.	•	•	•	•	•	•	•	•
935 Silber 10 St.	•	•	•	•	•	•	•	•
585 GG 1 St.					•	•		







SUMA FURNITUREN







Mulde 10 D-75239 Eisingen • ☎ +49 (0) 7232 809 454 • 📠 +49 (0) 7232 809 453 • ✉ info@sumafurnituren.de • www.sumafurnituren.de







Auflöt-Ornamente <i>Ornamente, paarweise</i> Ornaments for soldering <i>decoration, pairs</i>								
Länge x Breite x Höhe in mm ca.	9,2 x 7,0 x 1,5	9,2 x 7,0 x 1,5	7,0 x 3,9 x 1,0	7,0 x 3,9 x 1,0				
Artikel-Nr.	109/907	109/908	109/942L	109/942R				
935 Silber 1 St.	•	•	•	•				
935 Silber 10 St.	•	•	•	•				







Auflöt-Ornamente <i>Ornamente, paarweise</i> Ornaments for soldering <i>decoration, pairs</i>						
Länge x Breite x Höhe in mm ca.	20,0 x 8,5 x 1,3	20,0 x 8,5 x 1,3	15,2 x 9,7 x 2,2	15,2 x 9,7 x 2,2	12,7 x 10,0 x 2,8	12,7 x 10,0 x 2,8
Artikel-Nr.	109/787L	109/787R	109/941L	109/941R	109/950L	109/950R
935 Silber 1 St.	•	•	•	•	•	•
935 Silber 10 St.	•	•	•	•	•	•







Auflöt-Ornamente <i>Ornamente, einzeln</i> Ornaments for soldering <i>ornaments, single</i>						
Länge x Breite x Höhe in mm ca.	11,6 x 7,8 x 1,5	11,3 x 9,5 x 2,0	6,0 x 16,8 x 1,2	9,0 x 15,0 x 1,3	5,0 x 9,8 x 1,2	7,5 x 8,5
Artikel-Nr.	109/954	109/947	109/794	109/725	109/726	109/910
935 Silber 1 St.	•	•	•	•	•	•
935 Silber 10 St.	•	•	•	•	•	•
585 GG 1 St.		•				







Auflöt-Ornamente <i>Ornamente, einzeln</i> Ornaments for soldering <i>ornaments, single</i>						
Länge x Breite x Höhe in mm ca.	10,5 x 14,0 x 1,1	8,0 x 6,0 x 0,7	10,0 x 7,0 x 0,8	7,5 x 6,2 x 1,5	9,0 x 9,0 flach	9,0 x 9,0 x 1,0 gewölbt
Artikel-Nr.	109/61	109/118	109/588	109/551	109/552	109/552G
935 Silber 1 St.	•	•	•	•	•	•
935 Silber 10 St.	•	•	•	•	•	•

Auflöt-Ornamente <i>Ornamente, einzeln</i> Ornaments for soldering <i>ornaments, single</i>							
Länge x Breite x Höhe in mm ca.	6,6 x 8,3 x 2,4	8,8 x 5,5 x 1,9	14 x 9,5	13,5 x 9,0	10,0 x 6,0 x 2,2 gewölbt	9,5 x 8,0 x 1,8	10,1 x 7,4 x 1,4
Artikel-Nr.	109/282	109/542	109/73	109/226	109/541	109/790	109/837
935 Silber 1 St.	•	•	•	•	•	•	•
935 Silber 10 St.	•	•	•	•	•	•	•

Auflöt-Ornamente <i>Ornamente, einzeln</i> Ornaments for soldering <i>ornaments, single</i>							
Länge x Breite x Höhe in mm ca.	8,5 x 7,0 x 1,5 gewölbt	10,8 x 11,5 x 1,0 gewölbt	8,5 x 11,6 x 2,2	8,9 x 13,0 x 2,2	9,1 x 11,5 x 1,9	11,0 x 10,5 x 2,0 flach	4,7 x 7,3 x 1,8
Artikel-Nr.	109/571	109/569	109/60	109/534	109/59	109/585	109/931
935 Silber 1 St.	•	•	•	•	•	•	•
935 Silber 10 St.	•	•	•	•	•	•	•

Auflöt-Ornamente <i>Ornamente</i> Ornaments for soldering <i>ornaments</i>							
Länge x Breite x Höhe in mm ca.	7,2 x 8,1 x 1,6	8,0 x 5,5 x 1,5	10,0 x 3,5 x 1,6	11,0 x 5,0 x 2,0	11,5 x 8,5 x 3,8	12,0 x 5,1 x 2,3	11,4 x 8,1 x 2,5
Artikel-Nr.	109/452	109/670	109/701	109/770	109/1014	109/1015	109/1016
935 Silber 1 St.	•	•	•	•	•	•	•
935 Silber 10 St.	•	•	•	•	•	•	•

Zwischenglieder, massiv Connecting links, massive						
Abmessungen in mm ca.	14,9 x 6,5	20,0 x 8,4	11,8 x 9,2	17,0 x 11,5	16,3 x 12,8	19,5 x 13,7
Artikel-Nr.	205/28	205/31	205/34	205/37	205/38	205/39
935 Silber 1 St.	•	•	•	•	•	•

Zwischenglieder, massiv Connecting links, massive						
Abmessungen in mm ca.	24,1 x 10,5	15,8 x 3,9	21,0 x 9,1	21,2 x 8,9	21,9 x 7,9	13,8 x 5,4
Artikel-Nr.	205/41	205/43	205/46	205/48	205/49	205/51
935 Silber 1 St.	•	•	•	•	•	•

SUMA FURNITUREN

Mulde 10 D-75239 Eisingen • ☎ +49 (0) 7232 809 454 • 📠 +49 (0) 7232 809 453 • ✉ info@sumafurnituren.de • www.sumafurnituren.de

Erteilung eines SEPA-Basis-Lastschriftmandats

Wiederkehrende Zahlungen

Firma

Kunden-Nr.

Name

Adresse

Telefon / Fax

E-Mail

Datum / Unterschrift

Zahlungsempfänger:

SUMA W. Malok GmbH, Mulde 10, D-75239 Eisingen / Deutschland

Gläubiger-Identifikationsnummer:

Mandatsreferenz (Kundennummer):

Ich/wir ermächtige(n) die SUMA Werner Malok GmbH, Zahlungen von meinem/unserem Konto mittels Lastschrift einzuziehen. Zugleich weise(n) ich/wir mein/unser Kreditinstitut an, die von der SUMA Werner Malok GmbH auf mein/unser Konto gezogenen Lastschriften einzulösen.

Hinweis: Ich kann/Wir können innerhalb von acht Wochen, beginnend mit dem Belastungsdatum, die Erstattung des belasteten Betrages verlangen. Es gelten dabei die mit meinem/unserem Kreditinstitut vereinbarten Bedingungen.

Ich bin/wir sind damit einverstanden, dass zur Vereinfachung des Zahlungsverkehrs, die grundsätzliche 14-tägige Frist für die Information vor Einzug (Pre-Notification) einer fälligen Zahlung bis auf 2 Tage vor Belastung verkürzt werden kann.

IBAN

BIC

Kontoführendes Kreditinstitut
(genaue Bezeichnung)

SUMA W. Malok GmbH ist berechtigt, Entgelte und Gebühren, die durch Angabe von falschen Kontoangaben oder Rückbuchungen entstehen und nicht durch das Verschulden von SUMA W. Malok GmbH zustande kamen, dem oben genannten Zahlungspflichtigen weiterzubelasten.



Allgemeine Geschäftsbedingungen der SUMA Werner Malok GmbH • Eisingen • Stand: 1. Januar 2022

1. Geltungsbereich

1.1. Unsere ALLGEMEINEN GESCHÄFTSBEDINGUNGEN gelten ausschließlich. Soweit diese keine Regelungen enthalten, gilt das Gesetz. Entgegenstehende oder von unseren ALLGEMEINEN GESCHÄFTSBEDINGUNGEN oder von dem Gesetz zu unserem Nachteil abweichende Bedingungen des Vertragspartners erkennen wir nicht an, es sei denn, wir hätten ausdrücklich schriftlich ihrer Geltung zugestimmt. Unsere ALLGEMEINEN GESCHÄFTSBEDINGUNGEN gelten auch dann, wenn unsere Vertragsleistungen oder Lieferungen in Kenntnis entgegenstehender oder von unseren ALLGEMEINEN GESCHÄFTSBEDINGUNGEN oder zu unserem Nachteil von dem Gesetz abweichender Bedingungen des Vertragspartners vorbehaltlos erbracht werden.

1.2. Unsere ALLGEMEINEN GESCHÄFTSBEDINGUNGEN gelten auch für alle künftigen Geschäfte mit dem Vertragspartner.

1.3. Unsere ALLGEMEINEN GESCHÄFTSBEDINGUNGEN gelten nur gegenüber Unternehmern, juristischen Personen des öffentlichen Rechts oder öffentlich-rechtlichen Sondervermögen im Sinne von § 310 Abs. 1 BGB.

2. Angebote und Kostenanschläge

Unsere Angebote und Kostenanschläge sind – sofern nicht ausdrücklich als fest bezeichnet – freibleibend und unverbindlich.

An allen Angebots- und Vertragsunterlagen, insbesondere Entwürfen, Zeichnungen, Abbildungen etc. sowie Mustern, Modellen und Prototypen, behalten wir uns sämtliche Rechte insoweit vor, als sie nicht nach Sinn und Zweck des Vertrages bzw. auf Grund ausdrücklicher Vereinbarung dem Vertragspartner eingeräumt werden. Angebotsunterlagen sowie Muster, Modelle und Prototypen sind uns auf unser Verlangen unverzüglich zurückzugeben, wenn uns der Auftrag nicht erteilt wird. Ein Zurückbehaltungsrecht kann der Vertragspartner diesbezüglich nicht geltend machen.

3. Preise, Zahlungsbedingungen, Nacherfüllungsvorbehalt

3.1. Wir behalten uns das Recht vor, unsere Preise angemessen zu erhöhen, wenn nach Abschluss des Vertrages von uns nicht zu vertretende Kostenerhöhungen, insbesondere auf Grund von Tarifabschlüssen oder Materialpreiserhöhungen, eintreten. Diese werden wir dem Vertragspartner auf Verlangen nachweisen.

3.2. Unsere Preise verstehen sich vorbehaltlich gesonderter Vereinbarung ab Werk ausschließlich Porto, Versand, Fracht, Verpackung, Versicherung. Die Mehrwertsteuer wird in der jeweils gesetzlich vorgeschriebenen Höhe zusätzlich in Rechnung gestellt.

3.3. Vorbehaltlich gesonderter Vereinbarungen sind Zahlungen des Vertragspartners sofort und ohne Abzug fällig. Der Abzug von Skonto bedarf besonderer schriftlicher Vereinbarung. Der Vertragspartner kommt ohne weitere Erklärungen unsererseits zehn Tage nach dem Fälligkeitstag in Verzug, soweit er nicht bezahlt hat. Für die Folgen des Zahlungsverzugs gelten im Übrigen die gesetzlichen Bestimmungen.

3.4. Wir sind berechtigt, angemessene Abschlagszahlungen zusätzlich des darauf entfallenden gesetzlichen Mehrwertsteuerbetrages zu verlangen.

3.5. Wechsel und Schecks werden nur zahlungshalber angenommen, Wechsel nur bei vorheriger schriftlicher Vereinbarung. Der Diskont, die Spesen und die mit der Einziehung des Wechsels- und Scheckbetrages in Zusammenhang stehenden Kosten sind vom Vertragspartner zu tragen und sofort zur Zahlung fällig. Eine Erfüllungswirkung tritt erst mit Einlösung der Schecks bzw. Wechsel und unserer Befreiung aus jeglicher Haftung ein.

3.6. Aufrechnungsrechte stehen dem Vertragspartner nur zu, wenn seine Gegenansprüche rechtskräftig festgestellt, unbestritten oder anerkannt sind. Zur Ausübung eines Zurückbehaltungsrechts ist der Vertragspartner nur insoweit befugt, als sein Gegenanspruch auf dem gleichen Vertragsverhältnis beruht.

4. Liefer- oder Leistungszeit, nicht zu vertretende Liefer- oder Leistungsverzögerungen, Liefer- oder Leistungsverzug, Unmöglichkeit, Annahmeverzug, Verletzung von Mitwirkungspflichten

4.1. Die angegebenen Liefer- bzw. Leistungszeiten sind nur dann Fixtermine, wenn sie ausdrücklich als solche festgelegt werden.

4.2. Die Einhaltung von Liefer- bzw. Leistungsverpflichtungen, insbesondere Lieferterminen, setzt voraus:

> die rechtzeitige und ordnungsgemäße Erfüllung etwaiger Mitwirkungspflichten des Vertragspartners, insbesondere den Eingang vom Vertragspartner zu liefernder Unterlagen und Informationen;

> die Klärung sämtlicher technischer Einzelheiten mit dem Vertragspartner;

> den Eingang vereinbarter Abschlagszahlungen bzw. die Eröffnung vereinbarter Akkreditive;

> das Vorliegen etwaiger erforderlicher behördlicher Genehmigungen und Lizenzen.

Die Einrede des nicht erfüllten Vertrages bleibt vorbehalten.

4.3 Liefer- oder Leistungsverzögerungen auf Grund folgender Liefer- und Leistungshindernisse sind von uns – außer es wurden gerade in Bezug auf die Frist- bzw. Termineinhaltung ausnahmsweise ein Beschaffungsrisiko oder eine Garantie übernommen – nicht zu vertreten, entsprechendes gilt auch, wenn diese Hindernisse bei unseren Lieferanten oder deren Unterprioritäten eintreten:

> Umstände höherer Gewalt sowie Liefer- und Leistungshindernisse,

> die nach Vertragsschluss eintreten oder uns unverschuldet erst nach Vertragsschluss bekannt werden und

> bezüglich derer von uns der Nachweis geführt wird, dass sie auch durch die gebotene Sorgfalt von uns nicht vorausgesehen und verhütet werden konnten und uns insoweit auch kein Übernahme-, Vorsorge- und Abwendungsverhalten trifft.

Unter vorbenannten Voraussetzungen – Eintritt oder unverschuldetes Bekanntwerden erst nach Vertragsschluss, von uns nachgewiesene Unvorhersehbarkeit und Unvermeidbarkeit – zählen hierzu insbesondere:

Berechtigte Arbeitskämpfe (Streik und Aussperrungen); Betriebsstörungen; Rohstoffverknappung; Ausfall von Betriebs- und Hilfsstoffen. Schadensersatzansprüche des Vertragspartners sind bei Liefer- und Leistungsverzögerungen in vorstehenden Fällen ausgeschlossen. Bei einem endgültigen Liefer- und Leistungshindernis im vorstehenden Sinne ist jede Verzögerung zur sofortigen Vertragsbeendigung durch Rücktritt entsprechend den gesetzlichen Bestimmungen berechtigt.

Bei einem vorübergehenden Liefer- und Leistungshindernis im vorstehenden Sinne sind wir berechtigt, Lieferungen und Leistungen um die Dauer der Behinderung zzgl. einer angemessenen Anlaufzeit hinauszuschieben.

4.4 Wir haften für von uns zu vertretende Liefer- oder Leistungsverzögerungen nach den gesetzlichen Bestimmungen mit folgender Haftungsbeschränkung der Höhe nach:

Liegt kein vorsätzliches oder grob fahrlässiges Verhalten unsererseits, unserer gesetzlichen Vertreter oder Erfüllungsgehilfen vor, halten wir für jede vollendete Woche Verzug eine pauschalierte Verzugsentschädigung in Höhe von 0,5 % des Rechnungsn Nettobetrages der von dem Verzug betroffenen Lieferungen oder Leistungen, maximal jedoch insgesamt in Höhe von 5 % des Rechnungsn Nettobetrages. Bei grob fahrlässigem Verhalten unsererseits, unserer gesetzlichen Vertreter oder Erfüllungsgehilfen ist unser Schadensersatzhaftung auf den vorhersehbaren, typischerweise eintretenden Schaden begrenzt. Unsere Haftung ist auf den vorhersehbaren, typischerweise eintretenden Schaden begrenzt, außer die Liefer- oder Leistungsverzögerung beruht auf einer von uns, unseren gesetzlichen Vertretern oder Erfüllungsgehilfen zu vertretenden vorsätzlichen oder grob fahrlässigen Vertragsverletzung.

5. Übergang der Gefahr, Unsicherheitseinrede

5.1 Kommt auf unsere Lieferungen Kaufrecht zur Anwendung, geht die Gefahr des zufälligen Untergangs oder einer zufälligen Verschlechterung auf den Vertragspartner über, sobald die Lieferung an die zur Abholung oder Ausführung der Lieferung bestimmte Person oder Anstalt übergeben worden ist, spätestens jedoch mit Verlassen unseres Werks.

5.2 Sind wir aus einem gegenseitigen Vertrag zur Vorleistung verpflichtet, können wir die uns obliegende Leistung verweigern, wenn nach Vertragsabschluss erkennbar wird, dass unser Anspruch auf die Gegenleistung durch mangelnde Leistungsfähigkeit des Vertragspartners gefährdet wird. Wir können dem Vertragspartner eine angemessene Frist setzen, in welcher dieser Zug um Zug gegen unsere Leistung nach seiner Wahl die Gegenleistung zu bewirken oder Sicherheit zu leisten hat. Nach erfolglosem Fristablauf sind wir zum Rücktritt vom Vertrag berechtigt. Soweit wir unsere Leistung schon erbracht haben, können wir daraus resultierende noch nicht fällige Forderungen einschließlich solcher, für die Wechsel oder Schecks hingegeben wurden, mit sofortiger Wirkung fällig stellen. Stattdessen sind wir auch zum Rücktritt vom Vertrag berechtigt. Das Recht zur vorzeitigen Fälligkeitstellung von Forderungen aus demselben Rechtsverhältnis steht uns ferner schon dann zu, wenn der Vertragspartner mit mindestens 25% seiner uns gegenüber bestehenden Gesamtverbindlichkeiten (einfreie Hauptforderungen) länger als 6 Wochen in Zahlungsverzug geraten ist. Entsprechendes gilt, wenn uns bekannt wird, dass Wechsel protestiert oder Zwangsvollstreckungsmaßnahmen gegen den Vertragspartner eingeleitet werden oder eine sonstige Vermögensverschlechterung eintritt. Ein Rücktrittsrecht steht uns ferner zu, wenn der Vertragspartner über die seine Kreditwürdigkeit begründenden Tatsachen schuldhaft unrichtige oder unvollständige Angaben gemacht hat.

6. Eigentumsvorbehalt

6.1 Wir behalten uns das Eigentum an den Liefergegenständen („Vorbehaltslieferung“) bis zum Eingang aller Zahlungen aus der Geschäftsverbindung mit dem Vertragspartner vor. Der Eigentumsvorbehalt erstreckt sich auch auf den anerkannten Saldo, soweit wir Forderungen gegenüber dem Vertragspartner in laufende Rechnung buchen (Kontokorrent-Vorbehalt). Wird zur Bewirkung der an uns für die Vorbehaltslieferung zu leistenden Zahlungen eine wechselmäßige Haftung unsererseits begründet, erlischt der Eigentumsvorbehalt nicht vor Erlöschen unserer wechselmäßigen Haftung; bei Vereinbarung des Scheck-Wechsel-Verfahrens mit dem Vertragspartner erstreckt sich der Vorbehalt auch auf die Einlösung des von uns akzeptierten Wechsels durch den Vertragspartner und erlischt nicht durch Gutschrift des erhaltenen Schecks bei uns.

6.2 Der Vertragspartner ist berechtigt, die Vorbehaltslieferung im ordentlichen Geschäftsgang weiterzuverkaufen; er tritt uns jedoch bereits jetzt alle Forderungen in Höhe des Faktura-Endbetrages (einschließlich Mehrwertsteuer) unserer Forderungen ab, die ihm aus der Weiterveräußerung gegen seine Abnehmer oder Dritte erwachsen. Stellt der Vertragspartner die Forderungen aus einer Weiterveräußerung der Vorbehaltslieferung in ein mit seinem Abnehmer bestehendes Kontokorrentverhältnis ein, so ist die Kontokorrentforderung in Höhe des anerkannten Saldos abgetreten; gleiches gilt für den „kausalen“ Saldo im Falle der Insolvenz des Vertragspartners. Zur Einziehung der abgetretenen Forderungen ist der Vertragspartner auch nach deren Abtretung ermächtigt. Unsere Befugnis, die Forderungen selbst einzuziehen, bleibt – vorbehaltlich der insolvenzrechtlichen Regelungen – hiervon unberührt; jedoch verpflichten wir uns, die Forderungen nicht einzuziehen, solange der Vertragspartner seine Vertragspflichten nicht selbst, insbesondere seinen Zahlungsverpflichtungen ordnungsgemäß nachkommt, nicht in Zahlungsverzug gerät sowie kein Antrag auf Eröffnung eines Insolvenzverfahrens gestellt ist oder keine Zahlungseinstellung vorliegt.

6.3 Bei Wegfall unserer Verpflichtung gemäß vorstehend Ziff. 6.2, die Forderungen nicht selbst einzuziehen, sind wir – vorbehaltlich der insolvenzrechtlichen Regelungen – berechtigt, die Weiterveräußerungsbefugnis zu widerrufen und die Vorbehaltslieferung zurückzunehmen bzw. die Abtretung der Herausgabeansprüche des Vertragspartners gegen Dritte zu verlangen. In der Zurücknahme der Vorbehaltsware durch uns liegt ein Rücktritt vom Vertrag.

Die aus den vorgenannten Gründen zurückgenommene Vorbehaltslieferung dürfen wir – vorbehaltlich der insolvenzrechtlichen Regelungen – nach vorheriger Androhung und nach Fristsetzung angemessen verwerten; der Verwertungserlös ist auf die Verbindlichkeiten des Vertragspartners – abzüglich angemessener Verwertungskosten – anzurechnen.

Unter den Voraussetzungen, die uns zum Widerruf der Weiterveräußerungsbefugnis des Vertragspartners berechtigen, können wir auch die Einziehungsermächtigung widerrufen und verlangen, dass der Vertragspartner uns die abgetretenen Forderungen und deren Schuldner bekannt gibt, alle zum Einzug erforderlichen Angaben macht, die dazugehörigen Unterlagen aushändigt und den Schuldner (Dritten) die Abtretung mitteilt.

6.4 Bei Beschädigung oder Abhandenkommen der Vorbehaltslieferung sowie Besitz- und Wohnungswechsel hat uns der Vertragspartner unverzüglich schriftlich zu benachrichtigen. Entsprechendes gilt bei Pfändungen oder sonstigen Eingriffen Dritter, damit wir Klage gemäß § 771 ZPO erheben können. Soweit der Dritte nicht in der Lage ist, uns die gerichtlichen und außergerichtlichen Kosten einer Klage gemäß § 771 ZPO zu erstatten, haftet der Vertragspartner für den uns entstandenen Ausfall. Wird die Freigabe der Vorbehaltslieferung ohne Prozess erreicht, können auch die dabei entstandenen Kosten dem Vertragspartner angelastet werden, ebenso die Kosten der Rückschaffung der gepfändeten Vorbehaltslieferung.

6.5 Die Verarbeitung oder Umbildung der Vorbehaltslieferung durch den Vertragspartner wird stets für uns vorgenommen. Wird die Vorbehaltslieferung mit anderen, uns nicht gehörenden Gegenständen verarbeitet, so erwerben wir das Miteigentum an der neuen Sache im Verhältnis des Wertes der Vorbehaltslieferung (Faktura-Endbetrag einschließlich Mehrwertsteuer) zu den Werten der anderen verarbeiteten Gegenstände zur Zeit der Verarbeitung bzw. Umbildung.

Für die durch Verarbeitung bzw. Umbildung entstehende Sache gilt im Übrigen das gleiche wie für die Vorbehaltslieferung. An der durch Verarbeitung bzw. Umbildung entstehenden Sache erhält der Vertragspartner ein seinem Anwartschaftsrecht an der Vorbehaltslieferung entsprechendes Anwartschaftsrecht eingeräumt.

6.6 Wird die Vorbehaltslieferung mit anderen, uns nicht gehörenden Gegenständen untrennbar vermischt oder verbunden, so erwerben wir das Miteigentum an der neuen Sache im Verhältnis des Wertes der Vorbehaltslieferung (Faktura-Endbetrag einschließlich Mehrwertsteuer) zu den Werten der anderen vermischten oder verbundenen Gegenstände zum Zeitpunkt der Vermischung oder Verbindung. Erfolgt die Vermischung oder Verbindung in der Weise, dass die Sache des Vertragspartners als Hauptsache anzusehen ist, so gilt als vereinbart, dass der Vertragspartner uns anteilmäßig Miteigentum überträgt. Der Vertragspartner verwahrt das Alleineigentum oder das Miteigentum für uns.

6.7 Bei der Weiterveräußerung unserer Vorbehaltslieferung nach Verarbeitung oder Umbildung tritt der Vertragspartner seine Vergütungsansprüche in Höhe des Fakturaendbetrages (einschließlich Mehrwertsteuer) unserer Forderungen bereits jetzt sicherungshalber an uns ab.

Haben wir aufgrund der Verarbeitung bzw. Umbildung oder der Vermischung bzw. Verbindung der Vorbehaltslieferung mit anderen, uns nicht gehörenden Gegenständen nur Miteigentum gemäß vorstehender Ziff. 6.5 oder 6.6 erworben, wird der Vergütungsanspruch des Vertragspartners nur im Verhältnis des von uns für die Vorbehaltslieferung berechneten Endbetrages inklusive Mehrwertsteuer zu den Rechnungsendbeträgen der anderen, uns nicht gehörenden Gegenstände im Voraus an uns abgetreten.

Im Übrigen gelten für die im Voraus abgetretenen Forderungen die vorstehenden Ziff. 6.2 bis 6.4 entsprechend.

6.8 Ist der Eigentumsvorbehalt oder die Abtretung nach ausländischem Recht, in dessen Bereich sich unsere Vorbehaltslieferung befindet, nicht wirksam, so gilt die dem Eigentumsvorbehalt und der Abtretung in diesem Rechtsgebiet entsprechende Sicherung als vereinbart.

Ist zur Entstehung solcher Rechte die Mitwirkung des Vertragspartners erforderlich, so ist er auf unsere Anforderung hin verpflichtet, alle Maßnahmen zu ergreifen, die zur Begründung und Erhaltung solcher Rechte notwendig sind.

6.9 Der Vertragspartner ist verpflichtet, die Vorbehaltslieferung pfleglich zu behandeln und auf seine Kosten instand zu halten; der Vertragspartner ist insbesondere verpflichtet, die Vorbehaltslieferung auf seine Kosten zu unseren Gunsten ausreichend zum Neuwert gegen Diebstahl, Raub, Einbruch, Feuer- und Wasserschaden zu versichern. Der Vertragspartner tritt alle sich hieraus ergebenden Versicherungsansprüche hinsichtlich der Vorbehaltslieferung schon jetzt an uns ab. Wir nehmen die Abtretung an.

Darüber hinaus bleibt uns die Geltendmachung unserer Erfüllungs- bzw. Schadensersatzansprüche vorbehalten.

6.10 Der Vertragspartner tritt uns auch die Forderungen zur Sicherung unserer Forderungen gegen ihn ab, die durch die Verbindung der Vorbehaltslieferung mit einem Grundstück gegen einen Dritten erwachsen.

6.11 Wir verpflichten uns, die uns zustehenden Sicherheiten auf Verlangen des Vertragspartners insoweit freizugeben, als der realisierbare Wert unserer Sicherheiten die zu sichernden Forderungen um mehr als 10 % übersteigt; die Auswahl der freizugebenden Sicherheiten obliegt uns.

7. Rechte, Vertragsstrafe

Alle Rechte (insbesondere Eigentums- und Urheberrechte bzw. urheberrechtliche Verwertungsrechte sowie gewerbliche Schutzrechte) an den dem Vertragspartner im Rahmen unserer Geschäftsbeziehung überlassenen Vertragsunterlagen (insbesondere Entwürfe, Zeichnungen, Prospekte, Kataloge, Abbildungen, Kalkulationen, Produktbeschreibungen etc.) sowie Mustern, Modellen und Prototypen stehen – vorbehaltlich ausdrücklich

abweichender Vereinbarung – ausschließlich uns zu. Der Vertragspartner darf die vorbenannten Unterlagen, Muster, Modelle und Prototypen nur im Rahmen der mit uns abgeschlossenen Verträge und nur mit unserem Einverständnis verwenden und verwerten. Sie sind geheim zu halten, außer sie waren bereits bei Erhalt dem Vertragspartner bekannt oder allgemein zugänglich oder wurden später ohne Zutun oder Verantwortlichkeit des Vertragspartners offenkundig; sie dürfen insbesondere nur nach unserer vorherigen schriftlichen Zustimmung Dritten zugänglich gemacht werden. Mit Hilfe vorbenannter Unterlagen, Muster, Modelle und Prototypen dürfen unsere Liefergegenstände weder nachgeahmt noch in anderer Weise nachgebildet, noch derart nachgeahmte oder nachgebildete Produkte vertrieben oder in sonstiger Weise verwertet werden. Der Vertragspartner verpflichtet sich, bei jeder Zuwiderhandlung gegen vorbenannte Verpflichtungen eine Vertragsstrafe in Höhe von € 5.000,00 an uns zu bezahlen, sofern er nicht den Nachweis seines Nichtverschuldens führt. Die Geltendmachung eines darüberhinausgehenden Schadensersatzes behalten wir uns vor.

8. Leistungsbeschreibung, Mängelhaftung

8.1 Die in unseren Leistungsbeschreibungen aufgeführten Beschaffenheiten legen die Eigenschaften unserer Lieferungen und Leistungen umfassend und abschließend fest. Die Beschreibungen unserer Lieferungen und Leistungen sind im Zweifel Gegenstand von Beschaffenheitsvereinbarungen und nicht von Garantien oder Zusicherungen. Erklärungen unsererseits in Zusammenhang mit diesem Vertrag enthalten im Zweifel keine Garantien oder Zusicherungen im Sinne einer Haftungsverschärfung oder Übernahme einer besonderen Einstandspflicht. Im Zweifel sind nur ausdrückliche schriftliche Erklärungen unsererseits in Bezug auf die Abgabe von Garantien und Zusicherungen maßgeblich.

8.2 Es wird keine Gewähr für Schäden aus nachfolgenden Gründen übernommen: ungeeignete oder unsachgemäße Verwendung oder Bedienung, fehlerhafte Montage durch den Vertragspartner oder Dritte, natürliche Abnutzung, fehlerhafte oder nachlässige Behandlung, ungeeignete Betriebsmittel, mangelhafte Bauarbeiten, ungeeigneter Baugrund, Austauschwerkstoffe, chemische, elektrochemische oder elektrische Einflüsse (sofern sie nicht von uns zu vertreten sind), unsachgemäße und ohne vorherige Genehmigung durch uns erfolgte Änderungen oder Instandsetzungsarbeiten seitens des Vertragspartners oder Dritter.

8.3 Mängelansprüche des Vertragspartners bestehen nicht bei nur unerheblicher Abweichung von der vereinbarten Beschaffenheit oder bei nur unerheblicher Beeinträchtigung der Brauchbarkeit unserer Lieferungen bzw. Leistungen.

8.4 Die Mängelrechte des Vertragspartners setzen voraus, dass dieser seinen nach § 377 HGB geschuldeten Untersuchungs- und Rügeobliegenheiten ordnungsgemäß nachgekommen ist.

8.5 Soweit ein Mangel vorliegt, sind wir nach unserer Wahl zur Nacherfüllung in Form einer Mangelbeseitigung oder zur Lieferung einer neuen mangelfreien Sache berechtigt. Sollte eine der beiden oder beide Arten dieser Nacherfüllung unmöglich oder unverhältnismäßig sein, sind wir berechtigt, sie zu verweigern.

Wir können die Nacherfüllung auch verweigern, solange der Vertragspartner seine Zahlungspflichten uns gegenüber nicht in einem Umfang erfüllt, der dem mangelfreien Teil der erbrachten Leistung entspricht.

Wir sind verpflichtet, alle zum Zweck der Nacherfüllung erforderlichen Aufwendungen, insbesondere Transport-, Wege-, Arbeits- und Materialkosten zu tragen, soweit sich diese nicht dadurch erhöhen, dass die Lieferung nach einem anderen Ort als zum Erfüllungsort verbracht wurde, es sei denn, die Verbringung entspricht dem bestimmungsgemäßen Gebrauch.

Wir sind berechtigt, die Mangelbeseitigung auch durch Dritte ausführen zu lassen. Ersetzte Teile werden unser Eigentum.

8.6 Bei Unmöglichkeit oder Fehlschlagen der Nacherfüllung, schuldhafter und unzumutbarer Verzögerung oder ernsthafter und endgültiger Verweigerung der Nacherfüllung durch uns oder Unzumutbarkeit der Nacherfüllung für den Vertragspartner ist dieser nach seiner Wahl berechtigt, entweder den Kaufpreis entsprechend herabzusetzen (Minderung) oder vom Vertrag zurückzutreten (Rücktritt).

8.7 Soweit sich nachstehend aus Ziff. 8.8 und Ziff. 8.9 nichts anderes ergibt, sind weitere Ansprüche des Vertragspartners, die mit Mängeln unserer Lieferungen und Leistungen in Zusammenhang stehen, gleich aus welchem Rechtsgrund (insbesondere Schadensersatzansprüche wegen Mängeln und Pflichtverletzungen, deliktische Ansprüche auf Ersatz von Sachschäden sowie Ansprüche auf Aufwendungsersatz) ausgeschlossen; dies gilt insbesondere für Ansprüche aus Schäden außerhalb der Liefergegenstände, z. B. an anderen Sachen des Vertragspartners, sowie für den Anspruch auf Ersatz entgangenen Gewinns.

8.8 Der vorstehend Ziff. 8.7 geregelte Haftungsausschluss gilt nicht:

8.8.1 Für Schäden aus der Verletzung des Lebens, des Körpers oder der Gesundheit, die auf einer schuldhaften Pflichtverletzung unsererseits, unserer gesetzlichen Vertreter oder unserer Erfüllungsgehilfen beruhen;

8.8.2 für die zwingende Haftung nach dem Produkthaftungsgesetz;

8.8.3 bei schuldhafter Verletzung einer wesentlichen Vertragspflicht oder einer „Kardinalpflicht“ durch uns, unsere gesetzlichen Vertreter oder unsere Erfüllungsgehilfen; soweit keine vorsätzliche oder grob fahrlässige Vertragsverletzung vorliegt, ist die Schadensersatzhaftung auf den vorhersehbaren, typischerweise eintretenden Schaden begrenzt;

8.8.4 im Falle des arglistigen Verschweigens eines Mangels, bei Übernahme einer Garantie oder bei Versicherung einer Eigenschaft, falls gerade ein davon umfasster Mangel unsere Haftung auslöst;

8.8.5 für einen sonstigen von uns, unseren gesetzlichen Vertretern oder unseren Erfüllungsgehilfen zu vertretenden Anspruch des Vertragspartners auf Ersatz des Schadens statt der Leistung; soweit keine vorsätzliche oder grob fahrlässige Vertragsverletzung vorliegt, ist die Schadensersatzhaftung auf den vorhersehbaren, typischerweise eintretenden Schaden begrenzt;

8.8.6 für sonstige Schäden, die auf einer vorsätzlichen oder grob fahrlässigen Pflichtverletzung unsererseits, unserer gesetzlichen Vertreter oder unserer Erfüllungsgehilfen beruhen; soweit keine vorsätzliche Vertragsverletzung vorliegt, ist die Schadensersatzhaftung auf den vorhersehbaren, typischerweise eintretenden Schaden begrenzt.

8.9 Für den Fall des Aufwendungsersatzes gilt Ziff. 8.8 entsprechend.

8.10 Die gesetzlichen Regelungen über die Beweislast bleiben durch die vorstehenden Regelungen Ziff. 8., insbesondere Ziffern 8.7 bis 8.9, unberührt.

8.11 Regressansprüche des Vertragspartners gegen uns gemäß § 478 BGB (Rückgriff des Unternehmers) bestehen nur insoweit, als der Vertragspartner mit seinem Abnehmer keine über die gesetzlichen Mängelansprüche hinausgehenden Vereinbarungen getroffen hat. Im Übrigen bleiben Ansprüche aus Herstellerregress unberührt.

9. Rechte an Know-how und Erfindungen

Bei uns vorhandene bzw. während der Durchführung der mit uns abgeschlossenen Verträge gewonnene geheime, hochwertige und fortschrittliche Kenntnisse (Know-how) sowie Erfindungen und etwaige diesbezügliche gewerbliche Schutzrechte stehen – vorbehaltlich gesonderter Vereinbarung bzw. der dem Vertragspartner nach Sinn und Zweck des Vertragsverhältnisses zustehenden Nutzung oder Verwendung der Liefergegenstände – allein uns zu.

10. Verletzung der Rechte Dritter

Wir übernehmen keine Gewährleistung dafür, dass durch die Benutzung, den Einbau sowie den Weiterverkauf der Liefergegenstände keine Schutzrechte Dritter verletzt werden; wir sichern jedoch zu, dass uns das Bestehen derartiger Schutzrechte Dritter an den Liefergegenständen nicht bekannt ist.

11. Verjährung

Die Verjährungsfrist für Ansprüche und Rechte wegen Mängeln der Lieferungen bzw. Leistungen – gleich aus welchem Rechtsgrund – beträgt ein Jahr. Dies gilt jedoch nicht in den Fällen der §§ 438 Abs. 1 Nr. 1, 438 Abs. 1 Nr. 2, 479 Abs. 1 sowie 634 a) Abs. 1 Nr. 2 BGB; insoweit gilt eine Verjährungsfrist von drei Jahren. Die vorstehenden Verjährungsfristen gelten auch für sämtliche Schadensersatzansprüche gegen uns, die mit dem Mangel in Zusammenhang stehen.

12. Forderungsabtretungen durch den Vertragspartner

Forderungen gegenüber uns in Bezug auf die von uns zu erbringenden Lieferungen oder Leistungen dürfen nur mit unserer vorherigen schriftlichen Zustimmung abgetreten werden.

13. Erfüllungsort, Gerichtsstand, anzuwendendes Recht, innerschuldhaftlicher Erwerb, salvatorische Klausel

13.1 Vorbehaltlich besonderer Vereinbarung ist Erfüllungsort ausschließlich unser Geschäftssitz.

13.2 Ist der Vertragspartner Kaufmann im Sinne des Handelsgesetzbuches, juristische Person des öffentlichen Rechts oder öffentlich-rechtliches Sondervermögen, so ist Gerichtsstand für alle Verpflichtungen aus und in Zusammenhang mit dem Vertragsverhältnis – auch für Wechsel- und Schecksachen – unser Geschäftssitz oder nach unserer Wahl auch der Sitz des Vertragspartners. Vorstehende Gerichtsstandsvereinbarung gilt auch gegenüber Vertragspartnern mit Sitz im Ausland.

13.3 Für alle Rechte und Pflichten aus und in Zusammenhang mit dem Vertragsverhältnis kommt ausschließlich und ohne Rücksicht auf kollisionsrechtliche Regelungen das Recht der Bundesrepublik Deutschland unter Ausschluss des UN-Kaufrechts (CISG; Übereinkommen der Vereinten Nationen über Verträge über den internationalen Warenkauf vom 11.04.1980) zur Anwendung.

13.4 Sollte eine Bestimmung in diesen ALLGEMEINEN GESCHÄFTSBEDINGUNGEN oder eine Bestimmung im Rahmen sonstiger Vereinbarungen zwischen uns und dem Vertragspartner unwirksam sein oder werden, so wird hiervon die Wirksamkeit aller sonstigen Bestimmungen oder Vereinbarungen nicht berührt.

13.5 Vertragspartner aus EG-Mitgliedsstaaten sind uns bei innergemeinschaftlichem Erwerb zum Ersatz des Schadens verpflichtet, der uns möglicherweise entsteht

> aufgrund von Steuervergehen des Vertragspartners selbst oder

> aufgrund falscher oder unterlassener Auskünfte des Vertragspartners über seine für die Besteuerung maßgeblichen Verhältnisse.

14. Zusätzliche Besondere Bedingungen für Abwicklung Edelmetallkonto

14.1 Wir richten für unsere Vertragspartner Edelmetallkonten nach Maßgabe der nachfolgenden Bestimmungen ein. Beide Parteien sind berechtigt, das eingerichtete Edelmetallkonto unter Einhaltung einer Frist von einem Monat schriftlich zu kündigen. Die Kündigung aus wichtigem Grund bleibt vorbehalten.

14.2 Edelmetallbestände der einzelnen Kontoinhaber werden nicht getrennt gelagert. Die einzelnen Kontoinhaber bilden eine von uns verwaltete Eigentümergemeinschaft. Wir sind berechtigt, die Form und den Zustand der Metalle und Edelmetalle zu verändern. Jeder Kontoinhaber ist entsprechend der Höhe der auf seinem Konto verbuchten Gewichtsmenge eines Metalls oder Edelmetalls Miteigentümer am vorhandenen Gesamtbestand. Wir sind jedoch berechtigt, das Alleineigentum des Vertragspartners durch Aussonderung jederzeit wieder herzustellen. Bei Kauf oder Verkauf von Metallen oder Edelmetallen wird der Eigentumsübergang mit der Verbuchung auf dem jeweiligen Konto vollzogen.

14.3 Gewichtskonten dürfen nur aufgrund besonderer Vereinbarung mit dem Vertragspartner einen negativen Bestand aufweisen. Wir sind jederzeit berechtigt, den Ausgleich eines negativen Saldos des Edelmetallkontos zu verlangen. Statt Lieferung von Edelmetall können wir auch Ausgleich durch Zahlung des aktuellen Marktpreises verlangen. Guthaben auf Edelmetallkonten werden durch uns nicht verzinst. Negativsalden sind zu verzinsen.

14.4 Der Vertragspartner hat auf unsere Anforderung hin, ein Währungskonto einzurichten.

14.5 Der Vertragspartner kann nach seiner Wahl den Einsatz seines Kontoguthabens im Rahmen der Geschäftsbeziehung mit uns oder unter Berücksichtigung angemessener Fristen und handelsüblicher Gepflogenheiten die physische Herausgabe des vorhandenen Kontoguthabens verlangen. Die Herausgabe erfolgt, mangels anderweitiger schriftlicher Vereinbarung, am Sitz unserer Gesellschaft.

14.6 Die Gewichtskonten des Vertragspartners werden als Kontokorrentkonto geführt. Wir erteilen in regelmäßigen zeitlichen Abständen einen Rechnungsabschluss. Einwendungen wegen Unrichtigkeit oder Unvollständigkeit eines Rechnungsabschlusses hat der Vertragspartner spätestens vor Ablauf von sechs Wochen nach dessen Zugang zu erheben; macht er seine Einwendungen in Textform geltend, genügt die Absendung innerhalb der Sechs-Wochen-Frist. Das Unterlassen rechtzeitiger Einwendungen gilt als Genehmigung. Auf diese Folge werden wir bei Erteilung des Rechnungsabschlusses besonders hinweisen. Der Vertragspartner kann auch nach Fristablauf eine Berichtigung des Rechnungsabschlusses verlangen, muss dann aber beweisen, dass zu Unrecht sein Konto belastet oder eine ihm zustehende Gutschrift nicht erteilt wurde.

14.7 Fehlerhafte Gutschriften können unsererseits korrigiert werden. Eine Korrektur kann durch eine Stornobuchung oder durch eine Belastung auf dem Edelmetallkonto des Vertragspartners erfolgen. Wir werden den Vertragspartner über jedwede Korrektur unverzüglich unterrichten. Gutschriften, die infolge eines Irrtums, eines Schreibfehlers oder aus anderen Gründen vorgenommen werden, ohne dass ein entsprechender Auftrag vorliegt, dürfen von uns jederzeit storniert werden.

15. Zusätzliche Besondere Bedingungen für Auswahlgeschäfte

15.1 Die Durchführung und Aufrechterhaltung von Auswahlgeschäften erfolgt in alleiniger Verantwortlichkeit und auf alleinige Kosten des Vertragspartners.

15.2 Wir haben keine Verpflichtung, den Bestand beim Vertragspartner auf einem bestimmten Minimumbestand zu halten. Der Bestand ist in unserem freien Ermessen.

15.3 Die Auswahlware steht in unserem Eigentum. Der Vertragspartner wird uns das Eigentum an der Auswahlware betreffenden Vorkommnissen unverzüglich unterrichten. Die Auswahlware ist getrennt aufzubewahren und mit einem Eigentumsvermerk zu unseren Gunsten zu kennzeichnen.

15.4 Wir sind berechtigt, uns jederzeit selbst oder durch Dritte von der vorschriftsmäßigen Lagerung der Auswahlware zu überzeugen sowie eine Bestandsaufnahme vorzunehmen bzw. vornehmen zu lassen.

15.5 Der Vertragspartner ist verpflichtet, die Auswahlware bei der Einlieferung auf Menge und Mangelfreiheit, insbesondere auf Übereinstimmung mit der Spezifikation einschließlich der Artikelnummern, entsprechend den Vorschriften des HGB zu überprüfen. Etwaige Mängel sind uns unverzüglich unter Angabe der Artikelnummer anzuzeigen. Mängel, die bei der gebotenen Untersuchung nicht erkennbar waren, sind unverzüglich nach unserer Entdeckung anzuzeigen.

15.6 Der Vertragspartner haftet für Verlust, unsachgemäße Handhabung oder Beschädigung, der in seiner Verwahrung befindlichen Auswahlware, es sei denn, dass der Verlust, die unsachgemäße Handhabung oder Beschädigung auf Umständen beruht, die durch die Sorgfalt eines ordentlichen Kaufmanns nicht abgewendet werden kann.

15.7 Der Vertragspartner ist berechtigt, Auswahlware zur Abgabe an Anwender aus dem Lager zu entnehmen und an diese zu veräußern und zu übereignen. Bis zur vollständigen Bezahlung verbleibt es in unserem Eigentum. Es gilt Ziff. 6 dieser ALLGEMEINEN GESCHÄFTSBEDINGUNGEN.

15.8 Mit der Entnahme der Auswahlware kommt hinsichtlich der entnommenen Auswahlware zwischen uns und dem Vertragspartner ein Kaufvertrag gemäß dem am Tage der Entnahme gültigen oder vereinbarten Preise von uns zustande. Gleiches gilt, wenn Auswahlware nicht innerhalb der vereinbarten Frist zurückgegeben wird. Das Eigentum bleibt bis zur vollständigen Kaufpreiszahlung vorbehalten, es gilt Ziff. 6 dieser ALLGEMEINEN GESCHÄFTSBEDINGUNGEN.

15.9 Der Vertragspartner hat uns bis spätestens zum 10. eines jeden Monats die Menge der im Vormonat entnommenen Auswahlware zu melden. Diese Meldung hat unter Angabe der Artikelnummer und Entnahmemenge schriftlich an uns zu erfolgen. Wir erstellen auf der Basis der gemeldeten Verbrauchsmenge eine Rechnung mit Datum des Meldetages. Der Rechnungsausgleich hat durch den Vertragspartner gemäß den vereinbarten Zahlungsbedingungen zu erfolgen.

15.10 Wir können jederzeit Rücksendung der Kommissionare verlangen. Die Rücknahme erfolgt auf Kosten und Gefahr des Vertragspartners. Sollte bei Vertragsende die Auswahlware nicht innerhalb einer zu bestimmenden Frist herausgegeben werden, sind wir berechtigt, die nicht herausgegebene Auswahlware an den Vertragspartner zu fakturieren.

15.11 Der Vertragspartner kann gegenüber unserem Rückgabeverlangen kein Zurückbehaltungsrecht geltend machen. Lagerdifferenzen, nicht sachgemäße Handhabung oder Beschädigungen an der gelieferten Auswahlware werden dem Vertragspartner in Rechnung gestellt.

